

Certification Specifications  
for  
Very Light Aeroplanes

CS-VLA

Amendment 1  
5 March 2009

**CONTENTS (Layout)**  
**CS-VLA**  
**VERY LIGHT AEROPLANES**

**BOOK 1 – AIRWORTHINESS CODE**

SUBPART A — GENERAL

SUBPART B — FLIGHT

SUBPART C — STRUCTURE

SUBPART D — DESIGN AND CONSTRUCTION

SUBPART E — POWERPLANT

SUBPART F — EQUIPMENT

SUBPART G — OPERATING LIMITATIONS AND INFORMATION

APPENDICES: A, B, C and F

**BOOK 2 – ACCEPTABLE MEANS OF COMPLIANCE (AMC):**

**BOOK 1 CS-VLA**

**EASA Certification Specifications  
for  
Very Light Aeroplanes**

**CS-VLA  
Book 1**

**Airworthiness code**

# CS-VLA

## PREAMBLE

### *CS-VLA Amendment 1*

*Effective: 05/03/2009*

The following is a list of paragraphs affected by this amendment.

#### **Book 1**

##### Subpart D

- CS-VLA.783 Amended (NPA 2008-11)
- CS-VLA 807 Amended (NPA 2008-11)

#### **Book 2**

##### Subpart D

- AMC VLA.807(a) Created (NPA 2008-11)

## **BOOK 1 CS-VLA**

### **SUBPART A – GENERAL**

#### **CS-VLA 1      Applicability**

This airworthiness code is applicable to aeroplanes with a single engine (spark- or compression-ignition) having not more than two seats, with a Maximum Certificated Take-off Weight of not more than 750 kg and a stalling speed in the landing configuration of not more than 83 km/h (45 knots)(CAS), to be approved for day-VFR only. (See AMC VLA 1).

#### **CS-VLA 3      Aeroplane categories**

This CS-VLA applies to aeroplanes intended for non-aerobatic operation only. Non-aerobatic operation includes -

- (a) Any manoeuvre incident to normal flying;
- (b) Stalls (except whip stalls); and
- (c) Lazy eights, chandelles, and steep turns, in which the angle of bank is not more than 60°

# CS-VLA BOOK 1

## SUBPART B – FLIGHT

### GENERAL

#### CS-VLA 21 Proof of compliance

(a) Each requirement of this subpart must be met at each appropriate combination of weight and centre of gravity within the range of loading conditions for which certification is requested. This must be shown –

(1) By tests upon an aeroplane of the type for which certification is requested, or by calculations based on, and equal in accuracy to, the results of testing; and

(2) By systematic investigation of each probable combination of weight and centre of gravity, if compliance cannot be reasonably inferred upon combinations investigated.

(b) The following general tolerances are allowed during flight testing. However, greater tolerances may be allowed in particular tests.

Item	Tolerance
Weight	+5% , -10%
Critical items affected by weight	+5%, -1%
C.G.	±7% total travel.

(c) Substantiation of the data and characteristics to be determined according to this subpart may not require exceptional piloting skill, alertness or exceptionally favourable conditions. (See AMC VLA 21(c).)

(d) Consideration must be given to significant variations of performance and in-flight characteristics caused by rain and the accumulation of insects. (See AMC VLA 21(d).)

#### CS-VLA 23 Load distribution limits

Ranges of weight and centres of gravity within which the aeroplane may be safely operated must be established and must include the range of lateral centres of gravity if possible loading conditions can result in significant variation of their positions. (See AMC VLA 23.)

#### CS-VLA 25 Weight limits

(a) *Maximum weight.* The maximum weight is the highest weight at which compliance with each applicable requirement of this CS-VLA is shown. The maximum weight must be established so that it is -

(1) Not more than -

(i) The highest weight selected by the applicant;

(ii) The design maximum weight, which is the highest weight at which compliance with each applicable structural loading condition of this CS-VLA is shown; or

(iii) The highest weight at which compliance with each applicable flight requirement of this CS-VLA is shown.

(2) Assuming a weight of 86 kg for each occupant of each seat, not less than the weight with –

(i) Each seat occupied, full quantity of oil, and at least enough fuel for one hour of operation at rated maximum continuous power; or

(ii) One pilot, full quantity of oil, and fuel to full tank capacity.

(b) *Minimum weight.* The minimum weight (the lowest weight at which compliance with each applicable requirement of this CS-VLA is shown) must be established so that it is not more than the sum of –

(1) The empty weight determined under CS-VLA 29;

(2) The weight of the pilot (assumed as 55 kg); and

(3) The fuel necessary for one half hour of operation at maximum continuous power.

#### CS-VLA 29 Empty weight and corresponding centre of gravity

(a) The empty weight and corresponding centre of gravity must be determined by weighing the aeroplane with –

(1) Fixed ballast;

(2) Unusable fuel determined under CS-VLA 959; and

(3) Full operating fluids, including -

(i) Oil;

(ii) Hydraulic fluid; and

(iii) Other fluids required for operation of aeroplane systems,

(b) The condition of the aeroplane at the time of determining empty weight must be one that is well defined and can be easily repeated.

## CS-VLA BOOK 1

### CS-VLA 33 Propeller speed and pitch limits

(a) Propeller speed and pitch must be limited to values that ensure safe operation under normal operating conditions.

(b) Propellers that cannot be controlled in flight must meet the following requirements:

(1) During take-off and initial climb at  $V_Y$ , the propeller must limit the engine rotational speed at full throttle to a value not greater than the maximum allowable take-off rotational speed, and

(2) During a glide at  $V_{NE}$  with throttle closed or the engine inoperative, provided this has no detrimental effect on the engine, the propeller must not permit the engine to achieve a rotational speed greater than 110% of the maximum continuous speed.

(c) A propeller that can be controlled in flight but does not have constant speed controls must be so designed that –

(1) Sub-paragraph (b)(1) is met with the lowest possible pitch selected, and

(2) Sub-paragraph (b)(2) is met with the highest possible pitch selected.

(d) A controllable pitch propeller with constant speed controls must comply with the following requirements:

(1) With the governor in operation, there must be a means to limit the maximum engine rotational speed to the maximum allowable take-off speed, and

(2) With the governor inoperative, there must be a means to limit the maximum engine rotational speed to 103% of the maximum allowable take-off speed with the propeller blades at the lowest possible pitch and the aeroplane stationary with no wind at full throttle position.

## PERFORMANCE

### CS-VLA 45 General

Unless otherwise prescribed, the performance requirements of this CS-VLA must be met for still air and a standard atmosphere, at sea level. (See AMC VLA 45.)

### CS-VLA 49 Stalling speed

(a)  $V_{S0}$  is the stalling speed, if obtainable, or the minimum steady speed, in km/h (knots)

(CAS), at which the aeroplane is controllable, with the –

(1) Power condition set forth in subparagraph (c);

(2) Propeller in the take-off position;

(3) Landing gear extended;

(4) Wing flaps in the landing position;

(5) Cowl flaps closed;

(6) Centre of gravity in the most unfavourable position within the allowable range; and

(7) Maximum weight.

(b)  $V_{S0}$  may not exceed 83 km/h (45 knots) (CAS).

(c)  $V_{S1}$  is the stalling speed, if obtainable, or the minimum steady speed, in km/h (knots), (CAS) at which the aeroplane is controllable with –

(1) Engine idling, throttle closed;

(2) Propeller in the take-off position;

(3) Aeroplane in the condition existing in the test in which  $V_{S1}$  is being used; and

(4) Maximum weight.

(d)  $V_{S0}$  and  $V_{S1}$  must be determined by flight tests, using the procedure specified in CS-VLA 201.

### CS-VLA 51 Take-off

(a) The distance required to take-off from a dry, level, hard surface and climb over a 15 metre obstacle must be determined and must not exceed 500 metres.

(b) This must be determined, in a rational and conservative manner, with –

(1) The engine operating within approved operating limitations; and

(2) The cowl flaps in the normal take-off position.

(c) Upon reaching a height of 15 metres above the take-off surface level, the aeroplane must have reached a speed of not less than 1.3  $V_{S1}$ .

(d) The starting point for measuring take-off distance must be at rest except for seaplanes and amphibians where it may be a point at which a speed of not more than 5,6 km/h (three knots) is reached.

## CS-VLA BOOK 1

### CS-VLA 65 Climbs

The steady rate of climb must be at least 2m/sec with –

- (a) Not more than take-off power;
- (b) Landing gear retracted;
- (c) Wing flaps in take-off position; and
- (d) Cowl flaps in the position used in the cooling tests.

### CS-VLA 75 Landing

The horizontal distance necessary to land and come to a complete stop (or to a speed of approximately 5,6 km/h (3 knots) for water landings of seaplanes and amphibians) from a point 15 m above the landing surface must be determined as follows:

(a) A steady gliding approach with a calibrated airspeed of at least  $1.3 V_{S1}$  must be maintained down to the 15 m height.

(b) The landing must be made without excessive vertical acceleration or tendency to bounce, nose over, ground loop, porpoise, or water loop.

(c) It must be shown that a safe transition to the balked landing conditions of CS-VLA 77 can be made from the conditions that exist at the 15 m height.

### CS-VLA 77 Balked landing

For balked landings, it must be possible to maintain -

(a) A steady angle of climb at sea level of at least 1:30; or

(b) Level flight at an altitude of 915 m (3 000 ft) and at a speed at which the balked landing transition has been shown to be safe, with –

- (1) Take-off power;
- (2) The landing gear extended; and
- (3) The wing flaps in the landing position, except that if the flaps may be safely retracted in two seconds or less, without loss of altitude and without sudden changes of angle of attack or exceptional piloting skill, they may be retracted.

## FLIGHT CHARACTERISTICS

### CS-VLA 141 General

The aeroplane must meet the requirements of CS-VLA 143 to 251 at the normally expected operating altitudes.

## CONTROLLABILITY AND MANOEUVRABILITY

### CS-VLA 143 General

(a) The aeroplane must be safely controllable and manoeuvrable during –

- (1) Take-off;
- (2) Climb;
- (3) Level flight;
- (4) Descent; and
- (5) Landing (power on and power off) with the wing flaps extended and retracted.

(b) It must be possible to make a smooth transition from one flight condition to another (including turns and slips) without danger of exceeding the limit load factor, under any probable operating condition.

(c) If marginal conditions exist with regard to required pilot strength, the 'strength of pilots' limits must be shown by quantitative tests. In no case may the limits exceed those prescribed in the following table:



## CS-VLA BOOK 1

Values in daN of force as applied to the controls		Pitch	Roll	Yaw	Flaps, Trim tabs, landing gear etc
(a)	For temporary application:				
	Stick-----	20	10	-----	
	Wheel (applied to rim)-----	25	20	-----	
	Rudder pedal-----	-----	-----	40	
	Other controls-----	-----	-----	-----	20
(b)	For prolonged application -----	2	1.5	10	

### CS-VLA 145 Longitudinal Control

(a) It must be possible at any speed below  $1.3 V_{S1}$ , to pitch the nose downwards so that a speed equal to  $1.3 V_{S1}$  can be reached promptly.

(1) This must be shown with the aeroplane in all possible configurations, with power on at maximum continuous power and power idle, and with the aeroplane trimmed at  $1.3 V_{S1}$ .

(b) It must be possible throughout the appropriate flight envelope to change the configuration (landing gear, wing flaps etc ...) without exceeding the pilot forces defined in CS-VLA 143(c).

(c) It must be possible to raise the nose at  $V_{DF}$  at all permitted c.g. positions and engine powers.

(d) It must be possible to maintain steady straight flight and transition into climbs, descents, or turning flight, without exceeding the forces defined in CS-VLA 143(c).

(e) It must be possible to maintain approximately level flight when flap retraction from any position is made during steady horizontal flight at  $1.1 V_{S1}$  with simultaneous application of not more than maximum continuous power.

(f) For any trim setting required under CS-VLA 161(b)(1) it must be possible to take-off, climb, descend and land the aeroplane in required configurations with no adverse effect and with acceptable control forces.

### CS-VLA 153 Control during landings

It must be possible, while in the landing configuration, to safely complete a landing following an approach to land-

(a) At a speed 9.3 km/h (5 knots) less than the speed used in complying with CS-VLA 75 and with the aeroplane in trim or as nearly as possible in trim;

(b) With neither the trimming control being moved throughout the manoeuvre nor the power being increased during the landing flare; and

(c) With power off.

### CS-VLA 155 Elevator control forces in manoeuvres

The elevator control forces during turns or when recovering from manoeuvres must be such that an increase in control forces is needed to cause an increase in load factor. It must be shown by flight measurements that the stick force per 'g' is such that the stick force to achieve the positive limit manoeuvring load factor is not less than 7 daN in the clean configuration.

### CS-VLA 157 Rate of roll

(a) *Take-off.* It must be possible, using a favourable combination of controls, to roll the aeroplane from a steady 30 degree banked turn through an angle of 60 degrees, so as to reverse the direction of the turn within 5 seconds from initiation of roll with -

- (1) Flaps in the take-off position;
- (2) Landing gear retracted;
- (3) Maximum take-off power; and

(4) The aeroplane trimmed at  $1.2 V_{S1}$ , or as nearly as possible in trim for straight flight.

(b) *Approach.* It must be possible, using favourable combination of controls, to roll the aeroplane from a steady 30 degree banked turn through an angle of 60 degrees, so as to reverse the direction of the turn within 4 seconds from initiation of roll with -

- (1) Flaps extended;
- (2) Landing gear extended;
- (3) Engine operating at idle power and engine operating at the power for level flight; and

(4) The aeroplane trimmed at  $1.3 V_{S1}$ .

## CS-VLA BOOK 1

### TRIM

#### CS-VLA 161 Trim

(a) *Lateral and directional trim.* In level flight at  $0.9 V_H$  or  $V_C$  (whichever is lower) the aeroplane must remain in trimmed condition around roll and yaw axis with respective controls free. ( $V_H$  is maximum speed in level flight with maximum continuous power.)

(b) *Longitudinal trim*

(1) The aeroplane must maintain longitudinal trim in level flight at any speed from  $1.4 V_{S1}$  to  $0.9 V_H$  or  $V_C$  (whichever is lower).

(2) The aeroplane must maintain longitudinal trim during -

(i) A climb with maximum continuous power at a speed  $V_Y$  with landing gear and wing flaps retracted,

(ii) A descent with idle power at a speed of  $1.3 V_{S1}$  with landing gear extended, and Wing flaps in the landing position.

### STABILITY

#### CS-VLA 171 General

The aeroplane must be longitudinally, directionally, and laterally stable under CS-VLA 173 to 181. In addition, the aeroplane must show suitable stability and control 'feel' (static stability) in any condition normally encountered in service, if flight tests show it is necessary for safe operation.

#### CS-VLA 173 Static longitudinal stability

Under the conditions specified in CS-VLA 175 and with the aeroplane trimmed as indicated, the characteristics of the elevator control forces and the friction within the control system must be as follows:

(a) A pull must be required to obtain and maintain speeds below the specified trim speed and a push required to obtain and maintain speeds above the specified trim speed. This must be shown at any speed that can be obtained, except that speeds requiring a control force in excess of 18 daN, or speeds above the maximum allowable speed or below the minimum speed for steady unstalled flight, need not be considered.

(b) The airspeed must return to within  $\pm 10\%$  of the original trim speed when the control

force is slowly released at any speed within the speed range specified in sub-paragraph (a) of this paragraph.

(c) The stick force must vary with speed so that any substantial speed change results in a stick force clearly perceptible to the pilot. (See AMC VLA 173 and AMC VLA 175.)

#### CS-VLA 175 Demonstration of static longitudinal stability

Static longitudinal stability must be shown as follows:

(a) Climb. The stick force curve must have a stable slope, at speeds between 15% above and below the trim speed, with -

(1) Flaps in the climb position;

(2) Landing gear retracted;

(3) At least 75% of maximum continuous power; and

(4) The aeroplane trimmed for  $V_Y$ , except that the speed need not be less than  $1.4 V_{S1}$  or the speed used for showing compliance to the powerplant cooling requirement of CS-VLA 1041.

(b) *Cruise.* The stick force curve must have a stable slope with a range of 15% of the trim speed, but not exceeding the range from  $1.3 V_{S1}$  to  $V_{NE}$ , with -

(1) Flaps retracted;

(2) Landing gear retracted;

(3) 75% of maximum continuous power; and

(4) The aeroplane trimmed for level flight.

(c) *Approach and landing.* The stick force curve must have a stable slope at speeds throughout the range of speeds between  $1.1 V_{S1}$  and  $V_{FE}$  or  $1.8 V_{S1}$  if there is no  $V_{FE}$ , with -

(1) Wing flaps in the landing position;

(2) Landing gear extended;

(3) Power idle; and

(4) The aeroplane trimmed at  $1.3 V_{S1}$ . (See AMC VLA 173 and AMC VLA 175.)

## CS-VLA BOOK 1

### CS-VLA 177 Static directional and lateral

(a) *Three-control aeroplanes.* The stability requirements for three-control aeroplanes are as follows:

(1) The static directional stability, as shown by the tendency to recover from a skid with the rudder free, must be positive for any landing gear and flap position appropriate to the take-off, climb, cruise, and approach configurations. This must be shown with power up to maximum continuous power, and at speeds from  $1.2 V_{S1}$  up to maximum allowable speed for the condition being investigated. The angle of skid for these tests must be appropriate to the type of aeroplane. At larger angles of skid up to that at which full rudder is used or a control force limit in CS-VLA 143 is reached, whichever occurs first, and at speeds from  $1.2 V_{S1}$  to  $V_A$ , the rudder pedal force must not reverse.

(2) The static lateral stability, as shown by the tendency to raise the low wing in a slip, must be positive for any landing gear and flap positions. This must be shown with power up to 75% of maximum continuous power at speeds above  $1.2 V_{S1}$ , up to the maximum allowable speed for the configuration being investigated. The static lateral stability may not be negative at  $1.2 V_{S1}$ . The angle of slip for these tests must be appropriate to the type of aeroplane, but in no case may the slip angle be less than that obtainable with  $10^\circ$  of bank.

(3) In straight, steady slips at  $1.2 V_{S1}$  for any landing gear and flap positions, and for power conditions up to 50% of maximum continuous power, the aileron and rudder control movements and forces must increase steadily (but not necessarily in constant proportion) as the angle of slip is increased up to the maximum appropriate to the type of aeroplane. At larger slip angles up to the angle at which full rudder or aileron control is used or a control force limit contained in CS-VLA 143 is obtained, the rudder pedal force may not reverse. Enough bank must accompany slipping to hold a constant heading. Rapid entry into, or recovery from, a maximum slip may not result in uncontrollable flight characteristics.

(b) *Two-control (or simplified control) aeroplanes.* The stability requirements for two-control aeroplanes are as follows:

(1) The directional stability of the aeroplane must be shown by showing that, in each configuration, it can be rapidly rolled from a  $45^\circ$  bank in one direction to a  $45^\circ$  bank in the opposite direction without showing dangerous skid characteristics.

(2) The lateral stability of the aeroplane must be shown by showing that it will not assume a dangerous attitude or speed when the controls are abandoned for two minutes. This must be done in moderately smooth air with the aeroplane trimmed for straight level flight at  $0.9 V_H$  or  $V_C$ , whichever is lower, with flaps and landing gear retracted, and with a rearward centre of gravity.

### CS-VLA 181 Dynamic stability

(a) Any short period oscillation not including combined lateral-directional oscillations occurring between the stalling speed and the maximum allowable speed appropriate to the configuration of the aeroplane must be 'heavily damped with the primary controls –

- (1) Free; and
- (2) In a fixed position

(b) Any combined lateral-directional oscillations ('Dutch roll') occurring between the stalling speed and the maximum allowable speed appropriate to the configuration of the aeroplane must be damped to 1/10 amplitude in 7 cycles with the primary controls –

- (1) Free; and
- (2) In a fixed position.

## STALLS

### CS-VLA 201 Wings level stall

(a) For an aeroplane with independently controlled roll and directional controls, it must be possible to produce and to correct roll by unreversed use of the rolling control and to produce and to correct yaw by unreversed use of the directional control, up to the time the aeroplane stalls.

(b) For an aeroplane with interconnected lateral and directional controls (2 controls) and for an aeroplane with only one of these controls, it must be possible to produce and correct roll by unreversed use of the rolling control without producing excessive yaw, up to the time the aeroplane stalls.

## CS-VLA BOOK 1

(c) The wing level stall characteristics of the aeroplane must be demonstrated in flight as follows: The aeroplane speed must be reduced with the elevator control until the speed is slightly above the stalling speed, then the elevator control must be pulled back so that the rate of speed reduction will not exceed 1,9 km/h (one knot) per second until a stall is produced, as shown by an uncontrollable downward pitching motion of the aeroplane, or until the control reaches the stop. Normal use of the elevator control for recovery is allowed after the aeroplane has stalled.

(d) Except where made inapplicable by the special features of a particular type of aeroplane, the following apply to the measurement of loss of altitude during a stall

(1) The loss of altitude encountered in the stall (power on or power off) is the change in altitude (as observed on the sensitive altimeter testing installation) between the altitude at which the aeroplane pitches and the altitude at which horizontal flight is regained.

(2) If power or thrust is required during stall recovery the power or thrust used must be that which would be used under the normal operating procedures selected by the applicant for this manoeuvre. However, the power used to regain level flight may not be applied until flying control is regained.

(e) During the recovery part of the manoeuvre, it must be possible to prevent more than 15 degrees of roll Or yaw by the normal use of controls.

(f) Compliance with the requirements of this paragraph must be shown under the following conditions:

(1) *Wing Flaps*: Full up, full down and intermediate, if appropriate.

(2) *Landing Gear*: Retracted and extended.

(3) *Cowl Flaps*: Appropriate to configuration.

(4) *Power*: Power or thrust off, and 75% maximum continuous power or thrust.

(5) *Trim*: 1.5  $V_{S1}$  or at the minimum trim speed, whichever is higher.

(6) *Propeller*: Full increase rpm position for the power off condition. (See AMC VLA 201.)

### CS-VLA 203 Turning flight and accelerated stalls

Turning flight and accelerated stalls must be demonstrated in tests as follows:

(a) Establish and maintain a coordinated turn in a 30 degree bank. Reduce speed by steadily and progressively tightening the turn with the elevator until the aeroplane is stalled or until the elevator has reached its stop. The rate of speed reduction must be constant, and -

(1) For a turning flight stall, may not exceed 1,9 km/h (one knot) per second; and

(2) For an accelerated stall, be 5,6 to 9,3 km/h (3 to 5 knots) per second with steadily increasing normal acceleration.

(b) When the stall has fully developed or the elevator has reached its stop, it must be possible to regain level flight by normal use of controls and without -

(1) Excessive loss of altitude;

(2) Undue pitchup;

(3) Uncontrollable tendency to spin;

(4) Exceeding 60 degree of roll in either direction from the established 30 degree bank; and

(5) For accelerated entry stalls, without exceeding the maximum permissible speed or the allowable limit load factor.

(c) Compliance with the requirements of this paragraph must be shown with -

(1) *Wing Flaps*: Retracted and fully extended for turning flight and accelerated entry stalls, and intermediate, if appropriate, for accelerated entry stalls;

(2) *Landing Gear*: Retracted and extended;

(3) *Cowl Flaps*: Appropriate to configuration;

(4) *Power*: 75% maximum continuous power; and

(5) *Trim*: 1.5  $V_{S1}$  or minimum trim speed, whichever is higher.

### CS-VLA 207 Stall warning

(a) There must be a clear and distinctive stall warning, with the flaps and landing gear in any normal position, in straight and turning flight.

## CS-VLA BOOK 1

(b) The stall warning may be furnished either through the inherent aerodynamic qualities of the aeroplane or by a device that will give clearly distinguishable indications under expected conditions of flight. However, a visual stall warning device that requires the attention of the crew within the cockpit is not acceptable by itself.

(c) The stall warning must begin at a speed exceeding the stalling speed by a margin of not less than 9,3 km/h (5 knots), but not more than 18,5 km/h (10 knots) and must continue until the stall occurs.

### SPINNING

#### CS-VLA 221 Spinning

(a) The aeroplane must be able to recover from a one-turn spin or a 3-second spin, whichever takes longer, in not more than one additional turn, with the controls used in the manner normally used for recovery. In addition –

(1) For both the flaps-retracted and flaps-extended conditions, the applicable airspeed limit and positive limit manoeuvring load factor may not be exceeded;

(2) There may be no excessive back pressure during the spin or recovery; and

(3) It must be impossible to obtain uncontrollable spins with any use of the controls.

For the flaps-extended condition, the flaps may be retracted during recovery.

(b) *Aeroplanes* ‘characteristically incapable of spinning’. If it is desired to designate an aeroplane as ‘characteristically incapable of spinning’, this characteristic must be shown with -

(1) A weight five percent more than the highest weight for which approval is requested;

(2) A centre of gravity at least three percent of the mean aerodynamic chord aft of the rearmost position for which approval is requested;

(3) An available elevator up-travel 4° in excess of that to which the elevator travel is to be limited for approval; and

(4) An available rudder travel, 7° in both directions, in excess of that to which the rudder travel is to be limited for approval.

### GROUND AND WATER HANDLING CHARACTERISTICS

#### CS-VLA 231 Longitudinal stability and control

(a) A landplane may have no uncontrollable tendency to nose over in any reasonably expected operating condition, including rebound during landing or take-off. Wheel brakes must operate smoothly and may not induce any undue tendency to nose over.

(b) A seaplane or amphibian may not have dangerous or uncontrollable porpoising characteristics at any normal operating speed on the water.

#### CS-VLA 233 Directional stability and control

(a) There may be no uncontrollable ground or water looping tendency in 90° cross winds, up to a wind velocity of 18.5 km/h (10 knots) at any speed at which the aeroplane may be expected to be operated on the ground or water.

(b) A landplane must be satisfactorily controllable, without exceptional piloting skill or alertness, in power-off landings at normal landing speed, without using brakes or engine power to maintain a straight path.

(c) The aeroplane must have adequate directional control during taxiing.

#### CS-VLA 235 Taxiing condition

The shock-absorbing mechanism may not damage the structure of the aeroplane when the aeroplane is taxied on the roughest ground that may reasonably be expected in normal operation.

#### CS-VLA 239 Spray characteristics

Spray may not dangerously obscure the vision of the pilots or damage the propeller or other parts of a seaplane or amphibian at any time during taxiing, take-off, and landing.

### MISCELLANEOUS FLIGHT REQUIREMENTS

#### CS-VLA 251 Vibration and buffeting

Each part of the aeroplane must be free from excessive vibration under any appropriate speed and power conditions up to at least the minimum value of  $V_D$  allowed in CS-VLA 335. In addition, there may be no buffeting, in any normal flight condition, severe enough to

## CS-VLA BOOK 1

interfere with the satisfactory control of the aeroplane, cause excessive fatigue to the pilot, or result in structural damage. Stall warning buffeting within these limits is allowable.

# CS-VLA BOOK 1

## SUBPART C – STRUCTURE

### GENERAL

#### CS-VLA 301 Loads

(a) Strength requirements are specified in terms of limit loads (the maximum loads to be expected in service) and ultimate loads (limit loads multiplied by prescribed factors of safety). Unless otherwise provided, prescribed loads are limit loads.

(b) Unless otherwise provided, the air, ground, and water loads must be placed in equilibrium with inertia forces, considering each item of mass in the aeroplane. These loads must be distributed to conservatively approximate or closely represent actual conditions.

(c) If deflections under load would significantly change the distribution of external or internal loads, this redistribution must be taken into account.

(d) Simplified structural design criteria given in this Subpart C and its appendices may be used only for aeroplanes with conventional configurations. If Appendix A is used, the entire appendix must be substituted for the corresponding paragraphs of this subpart, i.e. CS-VLA 321 to 459. (See CS VLA 301 (d).)

#### CS-VLA 303 Factor of safety

Unless otherwise provided, a factor of safety of 1.5 must be used.

#### CS-VLA 305 Strength and deformation

(a) The structure must be able to support limit loads without detrimental, permanent deformation. At any load up to limit loads, the deformation may not interfere with safe operation.

(b) The structure must be able to support ultimate loads without failure for at least three seconds. However, when proof of strength is shown by dynamic tests simulating actual load conditions, the three second limit does not apply.

#### CS-VLA 307 Proof of structure

(a) Compliance with the strength and deformation requirements of CS-VLA 305 must be shown for each critical load condition. Structural analysis may be used only if the structure conforms to those for which experience has shown this method to be reliable. In other cases, substantiating load tests must be made. Dynamic tests, including structural flight tests,

are acceptable if the design load conditions have been simulated. (See AMC VLA 307 (a).)

(b) Certain parts of the structure must be tested as specified in Subpart D.

### FLIGHT LOADS

#### CS-VLA 321 General

(a) Flight load factors represent the ratio of the aerodynamic force component (acting normal to the assumed longitudinal axis of the aeroplane) to the weight of the aeroplane. A positive flight load factor is one in which the aerodynamic force acts upward, with respect to the aeroplane.

(b) Compliance with the flight load requirements of this subpart must be shown -

(1) At each critical altitude within the range in which the aeroplane may be expected to operate;

(2) At each practicable combination of weight and disposable load within the operating limitations specified in the Flight Manual.

#### CS-VLA 331 Symmetrical flight conditions

(a) The appropriate balancing horizontal tail load must be accounted for in a rational or conservative manner when determining the wing loads and linear inertia loads corresponding to any of the symmetrical flight conditions specified in CS-VLA 331 to 345.

(b) The incremental horizontal tail loads due to manoeuvring and gusts must be reacted by the angular inertia of the aeroplane in a rational or conservative manner.

#### CS-VLA 333 Flight envelope

(a) *General.* Compliance with the strength requirements of this subpart must be shown at any combination of airspeed and load factor on and within the boundaries of a flight envelope (similar to the one in sub-paragraph (d) of this paragraph) that represents the envelope of the flight loading conditions specified by the manoeuvring and gust criteria of sub-paragraphs (b) and (c) of this paragraph respectively.

(b) *Manoeuvring envelope.* Except where limited by maximum (static) lift coefficients, the aeroplane is assumed to be subjected to

## CS-VLA BOOK 1

symmetrical manoeuvres resulting in the following limit load factors:

- (1) The positive manoeuvring load factor specified in CS-VLA 337 at speeds up to  $V_D$ ;
- (2) The negative manoeuvring load factor specified in CS-VLA 337 at  $V_C$ ; and
- (3) Factors varying linearly with speed from the specified value at  $V_C$  to 0.0 at  $V_D$ .

(c) *Gust envelope*

(1) The aeroplane is assumed to be subjected to symmetrical vertical gusts in level flight. The resulting limit load factors must correspond to the conditions determined as follows:

- (i) Positive (up) and negative (down) gusts of 15.24 m/s at  $V_C$  must be considered.

- (ii) Positive and negative gusts of 7.62 m/s at  $V_D$  must be considered.

(2) The following assumptions must be made:

- (i) The shape of the gust is –

$$U = \frac{U_{de}}{2} \left( 1 - \cos \frac{2\pi S}{25\bar{C}} \right)$$

where–

$S$  = distance penetrated into gust (m);

$\bar{C}$  = mean geometric chord of wing (m); and

$U_{de}$  = derived gust velocity referred to in subparagraph (c)(1) (m/s)

- (ii) Gust load factors vary linearly with speed between  $V_C$  and  $V_D$ .

(d) *Flight envelope*

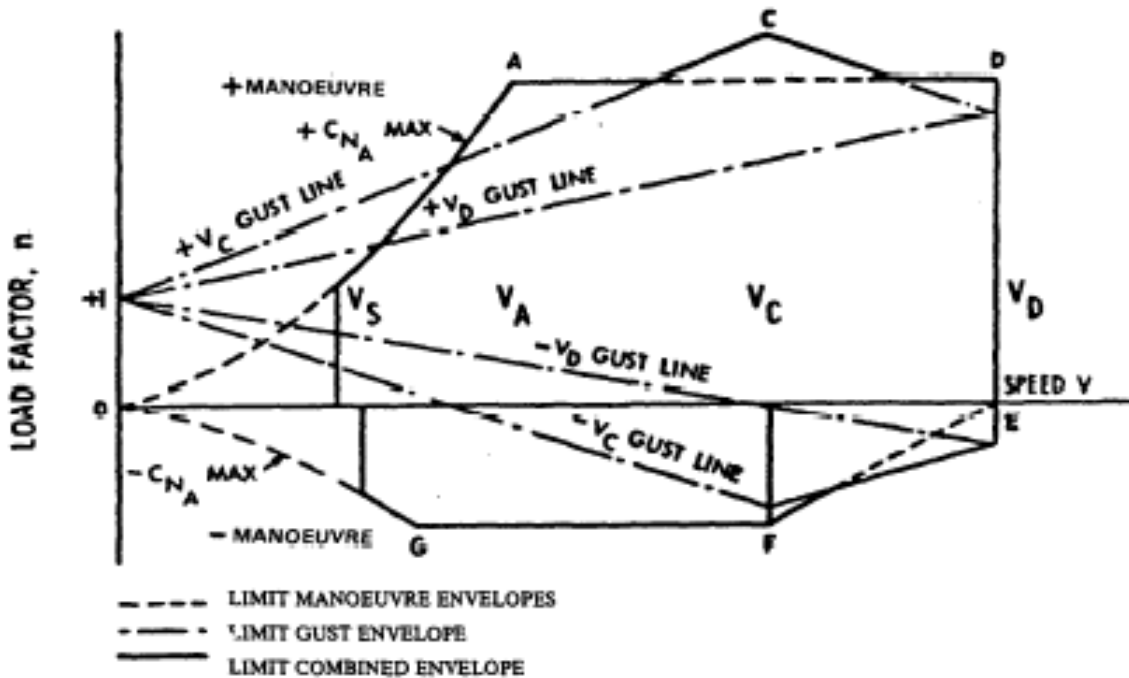

Point G need not be investigated when the supplementary condition specified in CS-VLA 369 is investigated.



## CS-VLA BOOK 1

### CS-VLA 335 Design airspeeds

Except as provided in sub-paragraph (a)(4) of this paragraph, the selected design airspeeds are equivalent airspeeds (EAS).

(a) *Design cruising speed,  $V_C$* . For  $V_C$  the following apply:

(1)  $V_C$  (in m/s) may not be less than –

$$2.4 \sqrt{Mg/S} \quad (V_C \text{ (kt)} = 4.7 \sqrt{Mg/S})$$

where –

$M/S$  = wing loading ( $\text{kg/m}^2$ )

$g$  = acceleration due to gravity ( $\text{m/s}^2$ )

(2)  $V_C$  need not be more than  $0.9 V_H$  at sea level.

(b) *Design dive speed  $V_D$* . For  $V_D$ , the following apply:

(1)  $V_D$  may not be less than  $1.25 V_C$ ; and

(2) With  $V_C$  min, the required minimum design cruising speed,  $V_D$  may not be less than  $1.40 V_{C\text{min}}$ .

(c) *Design manoeuvring speed  $V_A$* . For  $V_A$ , the following applies:

(1)  $V_A$  may not be less than  $V_S \sqrt{n}$ , where –

(i)  $V_S$  is a computed stalling speed with flaps retracted at the design weight, normally based on the maximum aeroplane normal force coefficients,  $C_{NA}$ ; and

(ii)  $n$  is the limit manoeuvring load factor used in design.

(2) The value of  $V_A$  need not exceed the value of  $V_C$  used in design

### CS-337 Limit manoeuvring load factors

(a) The positive limit manoeuvring load factor  $n$  may not be less than 3.8.

(b) The negative limit manoeuvring load factor may not be less than -1.5.

### CS-VLA 341 Gust load factors

In the absence of a more rational analysis, the gust load factors may be computed as follows:

$$n = 1 + \frac{1/2 \rho_0 V_a K_g U_{de}}{Mg/S}$$

where –

$K_g = \frac{0.88 \mu_g}{5.3 + \mu_g}$  = gust alleviation factor;

$\mu_g = \frac{2(M/S)}{\rho C_a}$  = aeroplane mass ratio;

$U_{de}$  = derived gust velocities referred to in CS-VLA 333(c) (m/s);

$\rho_0$  = density of air at sea level ( $\text{kg/m}^3$ );

$\rho$  = density of air ( $\text{kg/m}^3$ );

$M/S$  = wing loading ( $\text{kg/m}^2$ );

$\bar{C}$  = mean geometric chord (m);

$g$  = acceleration due to gravity ( $\text{m/s}^2$ );

$V$  = aeroplane equivalent speed (m/s); and

$a$  = slope of the aeroplane normal force coefficient curve  $C_{NA}$  per radian if the gust loads are applied to the wings and horizontal tail surfaces simultaneously by a rational method. The wing lift curve slope  $C_L$  per radian may be used when the gust load is applied to the wings only and the horizontal tail gust loads are treated as a separate condition.

### CS-VLA 345 High lift devices

(a) If flaps or similar high lift devices to be used for take-off, approach, or landing are installed, the aeroplane, with the flaps fully deflected at  $V_F$ , is assumed to be subjected to symmetrical manoeuvres and gusts resulting in limit load factors within the range determined by –

(1) Manoeuvring to a positive limit load factor of 2.0; and

(2) Positive and negative gust of 7.62 m/s acting normal to the flight path in level flight.

(b)  $V_F$  must be assumed to be not less than  $1.4 V_S$  or  $1.8 V_{SF}$ , whichever is greater, where –

$V_S$  is the computed stalling speed with flaps retracted at the design weight; and

$V_{SF}$  is the computed stalling speed with flaps fully extended at the design weight.

However, if an automatic flap load limiting device is used, the aeroplane may be designed

## CS-VLA BOOK 1

for the critical combinations of airspeed and flap position allowed by that device.

(c) In designing the flaps and supporting structures the following must be accounted for:

- (1) A head-on gust of 7.62 m/s (EAS).
- (2) The slipstream effects specified in CS-VLA 457 (b).

(d) In determining external loads on the aeroplane as a whole, thrust, slipstream, and pitching acceleration may be assumed to be zero.

(e) The requirements of CS-VLA 457, and this paragraph may be complied with separately or in combination.

### **CS-VLA 347      Unsymmetrical      flight conditions**

The aeroplane is assumed to be subjected to the unsymmetrical flight conditions of CS-VLA 349 and 351. Unbalanced aerodynamic moments about the centre of gravity must be reacted in a rational or conservative manner, considering the principal masses furnishing the reacting inertia forces.

### **CS-VLA                          349 Rolling conditions**

The wing and wing bracing must be designed for the following loading conditions:

(a) Unsymmetrical wing loads. Unless the following values result in unrealistic loads, the rolling accelerations may be obtained by modifying the symmetrical flight conditions in CS-VLA 333(d) as follows:

In condition A, assume that 100% of the semi-span wing airload acts on one side of the aeroplane and 70% of this load acts on the other side.

(b) The loads resulting from the aileron deflections and speeds specified in CS-VLA 455, in combination with an aeroplane load factor of at least two thirds of the positive manoeuvring load factor used for design. Unless the following values result in unrealistic loads, the effect of aileron displacement on wing torsion may be accounted for by adding the following increment to the basic aerofoil moment coefficient over the aileron portion of the span in the critical condition determined in CS-VLA 333 (d);

$$\Delta C_m = -0.01\delta$$

where –

$\Delta C_m$  is the moment coefficient increment; and

$\delta$  is the down aileron deflection in degrees in the critical condition.

### **CS-VLA 351      Yawing conditions**

The aeroplane must be designed for yawing loads on the vertical tail surfaces resulting from the loads specified in CS-VLA 441 to 445.

### **CS-VLA 361      Engine torque**

(a) The engine mount and its supporting structure must be designed for the effects of –

(1) A limit engine torque corresponding to take-off power and propeller speed acting simultaneously with 75% of the limit loads from flight condition A of CS-VLA 333 (d);

(2) The limit engine torque as specified in CS-VLA 361 (b) acting simultaneously with the limit loads from flight condition A of CS-VLA 333 (d); and

(b) The limit engine torque to be considered under subparagraph (a)(2) of this paragraph must be obtained by multiplying the mean torque for maximum continuous power by a factor determined as follows:

(1) For four-stroke engines –

- (i) 1.33 for engines with five or more cylinders,
- (ii) 2, 3, 4 or 8, for engines with four, three, two or one cylinders, respectively.

(2) For two-stroke engines –

- (i) 2 for engines with three or more cylinders,
- (ii) 3 or 6, for engines with two or one cylinder respectively.

### **CS-VLA 363      Side load on engine mount**

(a) The engine mount and its supporting structure must be designed for a limit load factor in a lateral direction, for the side load on the engine mount, of not less than 1.33.

(b) The side load prescribed in subparagraph (a) of this paragraph may be assumed to be independent of other flight conditions.

## CS-VLA BOOK 1

### CS-VLA 369 Special conditions for rear lift truss

(a) If a rear lift truss is used, it must be designed for conditions of reversed airflow at a design speed of –

$$V = 0.65 \sqrt{Mg/S} + 4.47$$

V in m/s    M/S = Wing loading (kg/m<sup>2</sup>)

M in kg

S in m<sup>2</sup>

g in m/s<sup>2</sup>

(b) Either aerodynamic data for the particular wing section used, or a value of  $C_L$  equaling -0.8 with a chordwise distribution that is triangular between a peak at the trailing edge and zero at the leading edge, must be used.

### CS-VLA 373 Speed control devices

If speed control devices (such as spoilers and drag flaps) are incorporated for use in en-route conditions -

(a) The aeroplane must be designed for the symmetrical manoeuvres and gusts prescribed in CS-VLA 333, 337 and 341, and the yawing and manoeuvres and lateral gusts in CS-VLA 441 and 443, with the device extended speed up to the placard device extended speed; and

(b) If the device has automatic operating or load limiting features, the aeroplane must be designed for the manoeuvre and gust conditions prescribed in sub-paragraph (a) of this paragraph at the speeds and corresponding device positions that the mechanism allows.

## CONTROL SURFACE AND SYSTEM LOADS

### CS-VLA 391 Control surface loads

(a) The control surface loads specified in CS-VLA 397 to 459 are assumed to occur in the conditions described in CS-VLA 331 to 351.

(b) If allowed by the following paragraphs, the values of control surface loading in Appendix B may be used, instead of particular control surface data, to determine the detailed rational requirements of CS-VLA 397 to 459, unless these values result in unrealistic loads.

### CS-VLA 395 Control system loads

(a) Each flight control system and its supporting structure must be designed for loads corresponding to at least 125% of the computed hinge moments of the movable control surface in the conditions prescribed in CS-VLA 391 to 459. In addition, the following apply:

(1) The system limit loads need not exceed the loads that can be produced by the pilot. Pilot forces used for design need not exceed the maximum forces prescribed in CS-VLA 397(b).

(2) The design must, in any case, provide a rugged system for service use, considering jamming, ground gusts, taxiing downwind, control inertia, and friction. Compliance with this sub-paragraph may be shown by designing for loads resulting from application of the minimum forces prescribed in CS-VLA 397(b).

(b) A 125% factor on computed hinge movements must be used to design elevator, aileron, and rudder systems. However, a factor as low as 1.0 may be used if hinge moments are based on accurate flight test data, the exact reduction depending upon the accuracy and reliability of the data.

(c) Pilot forces used for design are assumed to act at the appropriate control grips or pads as they would in flight, and to react at the attachments of the control system to the control surface horns.

### CS-VLA 397 Limit control forces and torques

(a) In the control surface flight loading condition, the airloads on movable surfaces and the corresponding deflections need not exceed those that would result in flight from the application of any pilot force within the ranges specified in subparagraph (b) of this paragraph. In applying this criterion the effects of tabs must be considered.

(b) The limit pilot forces and torques as follows:

## CS-VLA BOOK 1

Control	Maximum forces or torques in daN (D=wheel diameter)	Minimum forces or torques
Aileron:		
Stick -----	30 -----	17.8
Wheel* -----	22.2 D (mdaN)	17.8 D (mdaN)
Elevator:		
Stick -----	74 -----	44.5
Wheel (symmetrical) -	89 -----	44.5
Wheel (unsymmetrical)*	-----	44.5
Rudder -----	89 -----	58

\*The critical parts of the aileron control system must also be designed for a single tangential force with a limit value of 1.25 times the couple force determined from the above criteria.

(c) The rudder control system must be designed to a load of 100 daN per pedal, acting simultaneously on both pedals in forward direction.

### CS-VLA 399 Dual control systems

Dual control systems must be designed for -

- (a) The pilots acting together in the same direction; and
  - (b) The pilots acting in opposition,
- each pilot applying 0.75 times the load specified in CS-VLA 395(a).

### CS-VLA 405 Secondary control system

Secondary controls, such as wheel brakes, spoilers, and tab controls, must be designed for the maximum forces that a pilot is likely to apply to those controls. (See AMC VLA 405.)

### CS-VLA 407 Trim tab effects

The effects of trim tabs on the control surface design conditions must be accounted for only where the surface loads are limited by maximum pilot effort. In these cases, the tabs are considered to be deflected in the direction that would assist the pilot. These deflections must correspond to the maximum degree of 'out of trim' expected at the speed for the condition under consideration.

### CS-VLA 409 Tabs

Control surface tabs must be designed for the most severe combination of airspeed and tab

deflection likely to be obtained within the flight envelope for any usable loading condition.

### CS-VLA 415 Ground gust conditions

(a) The control system must be investigated as follows for control surface loads due to ground gusts and taxiing downwind:

(1) If an investigation of the control system for ground gust loads is not required by sub-paragraph (a)(2) of this paragraph, but the applicant elects to design a part of the control system for these loads, these loads need only be carried from control surface horns through the nearest stops or gust locks and their supporting structures.

(2) If pilot forces less than the minimum forces specified in CS-VLA 397(b) are used for design, the effects of surface loads due to ground gusts and taxiing downwind must be investigated for the entire control system according to the formula -

$$H = KcSq$$

where -

- H = limit hinge moment (Nm);
- c = mean chord of the control surface aft of the hinge line (m);
- S = area of the control surface aft of the hinge line (m<sup>2</sup>);
- q = dynamic pressure (Pa) based on a design speed not less than  $2.01 \sqrt{M/S} + 4.45$  (m/s), except that the design speed need not exceed 26.8 m/s; and
- K = limit hinge moment factor for ground gusts derived in sub-paragraph (b). (For ailerons and elevators, a positive value of K indicates a moment tending to depress the surface and a negative value of K indicates a moment tending to raise the surface.)

(b) The limit hinge moment factor K for ground gusts must be derived as follows:

## CS-VLA BOOK 1

Surface	K	Position of control
(a) Aileron	0.75	Control column locked or lashed in mid-position
(b) Aileron	±0.50	Ailerons at full throw; +moment on one aileron -moment on the other
(c) } Elevator	±0.75	{ (c) Elevator full up (-) (d) Elevator full down (+)
(d)		
(e) } Rudder	±0.75	{ (e) Rudder in neutral (f) Rudder at full throw
(f)		

### HORIZONTAL TAIL SURFACES

#### CS-VLA 421 Balancing loads

(a) A horizontal tail balancing load is a load necessary to maintain equilibrium in any specified flight condition with no pitching acceleration.

(b) Horizontal tail surfaces must be designed for the balancing loads occurring at any point on the limit manoeuvring envelope and in the flap conditions specified in CS-VLA 345. The distribution in figure B6 of Appendix B may be used.

#### CS-VLA 423 Manoeuvring loads

Each horizontal tail surface must be designed for manoeuvring loads imposed by one of the following conditions (a) plus (b), or (c), or (d):

(a) A sudden deflection of the elevator control, at  $V_A$ , to (1) the maximum upward deflection, and (2) the maximum downward deflection, as limited by the control stops, or pilot effort, whichever is critical. The average loading of B11 of Appendix B and the distribution in figure B7 of Appendix B may be used.

(b) A sudden upward deflection of the elevator, at speeds above  $V_A$ , followed by a downward deflection of the elevator, resulting in the following combinations of normal and angular acceleration:

Condition	Normal acceleration (n)	Angular acceleration (radian/sec <sup>2</sup> )
Down load	1.0	$+\frac{20.1}{V}n_m(n_m-1.5)$
Up load	$n_m$	$-\frac{20.1}{V}n_m(n_m-1.5)$

where –

(1)  $n_m$  = positive limit manoeuvring load factor used in the design of the aeroplane; and

(2)  $V$  = initial speed in m/s.

The conditions in this paragraph involve loads corresponding to the loads that may occur in a ‘checked manoeuvre’ (a manoeuvre in which the pitching control is suddenly displaced in one direction and then suddenly moved in the opposite direction), the deflections and timing avoiding exceeding the limit manoeuvring loads factor. The total tail load for both down and up load conditions is the sum of the balancing tail loads a  $V$  and the specified value of the normal load factor  $n$ , plus the manoeuvring load increment due to the specified value of the normal load factor  $n$ , plus the manoeuvring load increment due to the specified value of the angular acceleration. The manoeuvring load increment in figure B2 of Appendix B and the distributions in figure B7 (for down loads) and in figure B8 (for up loads) of Appendix B may be used.

(c) A sudden deflection of the elevator, the following cases must be considered:

(i) Speed  $V_A$ , maximum upward deflection;

(ii) Speed  $V_A$ , maximum downward deflection;

(iii) Speed  $V_D$ , one-third maximum upward deflection;

(iv) Speed  $V_D$ , one-third maximum downward deflection.

The following assumptions must be made:

(A) The aeroplane is initially in level flight, and its attitude and air speed do not change.

(B) The loads are balanced by inertia forces.

(d) A sudden deflection of the elevator such as to cause the normal acceleration to change

## CS-VLA BOOK 1

from an initial value to a final value, the following cases being considered (see Figure 1):

Speed	Initial Condition	Final Condition	Load Factor Increment
$V_A$	$A_1$	A	$n_1 - 1$
	A	$A_1$	$1 - n_1$
	$A_1$	G	$n_4 - 1$
	G	$A_1$	$1 - n_4$
$V_D$	$D_1$	D	$n_2 - 1$
	D	$D_1$	$1 - n_2$
	$D_1$	E	$n_3 - 1$
	E	$D_1$	$1 - n_3$

(See CS-VLA 33.)

For the purpose of this calculation the difference in air speed between  $V_A$  and the value corresponding to point G on the manoeuvring envelope can be ignored.

The following assumptions must be made:

- (1) The aeroplane is initially in level flight, and its attitude and airspeed do not change;
- (2) The loads are balanced by inertia forces;
- (3) The aerodynamic tail load increment is given by –

$$\Delta P = \Delta n M g \left[ \frac{X_{cg}}{l_t} - \frac{S_{ht} a_{ht}}{S a} \left( 1 - \frac{d\varepsilon}{d\alpha} \right) - \frac{\rho_0}{2} \left( \frac{S_{ht} a_{ht} l_t}{M} \right) \right]$$

where -

$\Delta P$  = horizontal tail load increment, positive upwards (N)

$\Delta n$  = load factor increment

$M$  = mass of the aeroplane (kg)

$g$  = acceleration due to gravity ( $m/s^2$ )

$x_{cg}$  = longitudinal distance of aeroplane c.g. aft of aerodynamic centre of aeroplane less horizontal tail (m)

$S_{ht}$  = horizontal tail area ( $m^2$ )

$a_{ht}$  = slope of horizontal tail lift curve per radian

$\frac{d\varepsilon}{d\alpha}$  = rate of change of downwash angle with angle of attack

$\rho_0$  = density of air at sea-level ( $kg/m^3$ )

$l_t$  = tail arm (m)

$S$  = wing area ( $m^2$ )

$a$  = slope of wing lift curve per radian

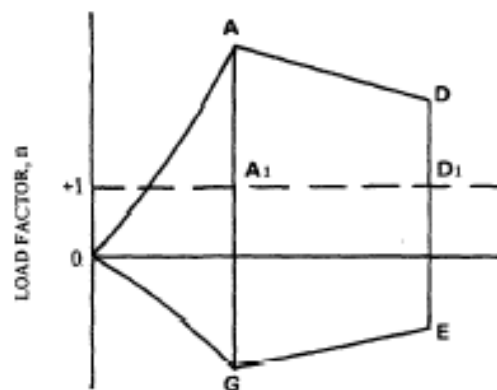

FIGURE 1 PITCHING MANOEUVRES

### CS-VLA 425 Gust loads

(a) Each horizontal tail surface must be designed for loads resulting from -

- (1) Gust velocities specified in CS-VLA 333(c) with flaps retracted; and
- (2) Positive and negative gusts of 7.62 m/s nominal intensity at  $V_F$  corresponding to the flight conditions specified in CS-VLA 345(a)(2).

(b) The average loadings in figure B3 and the distribution of figure B8 may be used to determine the incremental gust loads for the requirements of subparagraph (a) applied as both up and down increments for subparagraph (c).

(c) When determining the total load on the horizontal tail for the conditions specified in sub-paragraph (a) of this paragraph, the initial balancing tail loads for steady unaccelerated flight at the pertinent design speeds  $V_F$ ,  $V_C$  and  $V_D$  must first be determined. The incremental tail load resulting from the gusts must be added to the initial balancing tail load to obtain the total tail load.

(d) In the absence of a more rational analysis, the incremental tail load due to the gust, must be computed as follows:

$$\Delta L_{ht} = \frac{K_g U_{de} V a_{ht} S_{ht}}{16 \cdot 3} \left( 1 - \frac{d\varepsilon}{d\alpha} \right)$$

where-

$\Delta L_{ht}$  = incremental horizontal tail load (daN);

$K_g$  = gust alleviation factor defined in CS-VLA 341;

$U_{de}$  = derived gust velocity (m/s);

$V$  = aeroplane equivalent speed (m/s);

## CS-VLA BOOK 1

$a_{ht}$  = slope of horizontal tail lift curve per radian;

$S_{ht}$  = area of horizontal tail ( $m^2$ ); and

$(1 - \frac{d\epsilon}{d\alpha})$  = downwash factor.

### CS-VLA 427 Unsymmetrical loads

(a) Horizontal tail surfaces and their supporting structure must be designed for unsymmetrical loads arising from yawing and slipstream effects, in combination with the loads prescribed for the flight conditions set forth in CS-VLA 421 to 425.

(b) In the absence of more rational data for aeroplanes that are conventional in regard to location of the engine, wings, tail surfaces, and fuselage shape -

(1) 100% of the maximum loading from the symmetrical flight conditions may be assumed on the surface on one side of the plane of symmetry; and

(2) The following percentage of that loading must be applied to the opposite side:

% =  $100 - 10(n - 1)$ , where  $n$  is the specified positive manoeuvring load factor, but this value may not be more than 80%.

### VERTICAL TAIL SURFACES

#### CS-VLA 441 Manoeuvring loads

(a) At speeds up to  $V_A$ , the vertical tail surfaces must be designed to withstand the following conditions. In computing the tail loads, the yawing velocity may be assumed to be zero -

(1) With the aeroplane in unaccelerated flight at zero yaw, it is assumed that the rudder control is suddenly displaced to the maximum deflection, as limited by the control stops or by limit pilot forces.

(2) With the rudder deflected as specified in sub-paragraph (a)(1) of this paragraph, it is assumed that the aeroplane yaws to the resulting sideslip angle. In lieu of a rational analysis, an overswing angle equal to 1.3 times the static sideslip angle of sub-paragraph (a)(3) of this paragraph may be assumed.

(3) A yaw angle of 15 degrees with the rudder control maintained in the neutral position (except as limited by pilot strength).

(b) The average loading of Appendix B, B11 and figure B1 of Appendix B and the distribution in figures B6, B7 and B8 of Appendix B may be used instead of requirements of subparagraphs (a)(2), (a)(1) and (a)(3) of this paragraph, respectively.

(c) The yaw angles specified in subparagraph (a)(3) of this paragraph may be reduced if the yaw angle chosen for a particular speed cannot be exceeded in -

(1) Steady slip conditions;

(2) Uncoordinated rolls from steep banks. (See AMC VLA 441.)

### CS-VLA 443 Gust loads

(a) Vertical tail surfaces must be designed to withstand, in unaccelerated flight at speed  $V_C$ , lateral gusts of the values prescribed for  $V_C$  in CS-VLA 333 (c).

(b) In the absence of a more rational analysis, the gust load must be computed as follows:

$$L_{vt} = \frac{K_{gt} U_{de} V_{a_{vt}} S_{vt}}{16.3}$$

where -

$L_{vt}$  = vertical tail loads (daN);

$K_{gt} = \frac{0.88 \mu_{gt}}{5.3 + \mu_{gt}}$  = gust alleviation factor;

$\mu_{gt} = \frac{2M}{\rho C_t g_{a_{vt}} S_{vt}} \left( \frac{K}{l_t} \right)^2$  = lateral mass ratio;

$U_{de}$  = derived gust velocities ( m/s );

$\rho$  = air density ( $kg/m^3$ );

$M$  = aeroplane mass (kg);

$S_{vt}$  = area of vertical tail ( $m^2$ );

$\bar{C}_t$  = mean geometric chord of vertical surface (m);

$a_{vt}$  = lift curve slope of vertical tail (per radian);

$K$  = radius of gyration in yaw (m);

$l_t$  = distance from aeroplane c.g. to lift centre of vertical surface (m);

$g$  = acceleration due to gravity ( $m/s^2$ );

and

$V$  = aeroplane equivalent speed (m/s).

## CS-VLA BOOK 1

(c) The average loading in figure B5 and the distribution in figure B8 of Appendix B may be used. (See AMC VLA 443.)

### CS-VLA 445 Outboard fins

(a) If outboard fins are on the horizontal tail surface, the tail surfaces must be designed for the maximum horizontal surface load in combination with the corresponding loads induced on the vertical surfaces by endplate effects. These induced effects need not be combined with other vertical surface loads.

(b) If outboard fins extend above and below the horizontal surface, the critical vertical surface loading (the load per unit area as determined under CS-VLA 441 and 443) must be applied to –

(1) The part of the vertical surfaces above the horizontal surface with 80% of that loading applied to the part below the horizontal surface; and

(2) The part of the vertical surfaces below the horizontal surface with 80% of that loading applied to the part above the horizontal surface; and

(c) The endplate effects of outboard fins must be taken into account in applying the yawing conditions of CS-VLA 441 and 443 to the vertical surfaces in sub-paragraph (b) of this paragraph.

### SUPPLEMENTARY CONDITIONS FOR TAIL SURFACES

#### CS-VLA 447 Combined loads on tail surfaces

(a) With the aeroplane in a loading condition corresponding to point A or D in the V-n diagram (whichever condition leads to the higher balance load) the loads on the horizontal tail must be combined with those on the vertical tail as specified in CS-VLA 441.

(b) 75% of the loads according to CS-VLA 423 for the horizontal tail and CS-VLA 441 for the vertical tail must be assumed to be acting simultaneously.

#### CS-VLA 449 Additional loads applicable to V-tails

An aeroplane with V-tail, must be designed for a gust acting perpendicularly with respect to one of the tail surfaces at speed  $V_E$ . This case is

supplemental to the equivalent horizontal and vertical tail cases specified. Mutual interference between the V-tail surfaces must be adequately accounted for.

### AILERONS, WING FLAPS, AND SPECIAL DEVICES

#### CS-VLA 455 Ailerons

(a) The ailerons must be designed for the loads to which they are subjected

(1) In the neutral position during symmetrical flight conditions; and

(2) By the following deflections (except as limited by pilot effort), during unsymmetrical flight conditions; and

(i) Sudden maximum displacement of the aileron control at  $V_A$ . Suitable allowance may be made for control system deflections.

(ii) Sufficient deflection at  $V_C$ , where  $V_C$  is more than  $V_A$ , to produce a rate of roll not less than obtained in subparagraph (a)(2)(i) of this paragraph.

(iii) Sufficient deflection at  $V_D$  to produce a rate of roll not less than one-third of that obtained in subparagraph (a)(2)(i) of this paragraph.

(b) The average loading in Appendix B, B11 and figure B1 of Appendix B and the distribution in figure B9 of Appendix B may be used.

#### CS-VLA 457 Wing flaps

(a) The wing flaps, their operating mechanisms, and their supporting structures must be designed for critical loads occurring in the flaps-extended flight conditions with the flaps in any position. However, if an automatic flap load limiting device is used, these components may be designed for the critical combinations of airspeed and flap position allowed by that device.

(b) The effects of propeller slipstream, corresponding to take-off power, must be taken into account at not less than  $1.4 V_S$ , where  $V_S$  is the computed stalling speed with flaps fully retracted at the design weight. For the investigation of slipstream effects, the load factor may be assumed to be 1.0.



## CS-VLA BOOK 1

### CS-VLA 459 Special devices

The loading for special devices using aerodynamic surfaces (such as slots and spoilers) must be determined from test data.

### GROUND LOADS

#### CS-VLA 471 General

The limit ground loads specified in this subpart are considered to be external loads and inertia forces that act upon an aeroplane structure. In each specified ground load condition, the external reactions must be placed in equilibrium with the linear and angular inertia forces in a rational or conservative manner.

#### CS-VLA 473 Ground load conditions and assumptions

(a) The ground load requirements of this subpart must be complied with at the design maximum weight.

(b) The selected limit vertical inertia load factor at the centre of gravity of the aeroplane for the ground load conditions prescribed in this subpart may not be less than that which would be obtained when landing with a descent velocity ( $V$ ), in metres per second, equal to  $0.51 (Mg/S)^{1/4}$  except that this velocity need not be more than 3.05 m/s and may not be less than 2.13 m/s.

(c) Wing lift not exceeding two-thirds of the weight of the aeroplane may be assumed to exist throughout the landing impact and to act through the centre of gravity. The ground reaction load factor may be equal to the inertia load factor minus the ratio of the above assumed wing lift to the aeroplane weight.

(d) If energy absorption tests are made to determine the limit load factor corresponding to the required limit descent velocities, these tests must be made under CS-VLA 725.

(e) No inertia load factor used for design purposes may be less than 2.67, nor may the limit ground reaction load factor be less than 2.00 at design maximum weight, unless these lower values will not be exceeded in taxiing at speeds up to take-off speed over terrain as rough as that expected in service.

#### CS-VLA 477 Landing gear arrangement

Paragraphs CS-VLA 479 to 483, or the conditions in Appendix C, apply to aeroplanes with conventional arrangements of main and nose gear, or main and tail gear.

#### CS-VLA 479 Level landing conditions

(a) For a level landing, the aeroplane is assumed to be in the following attitudes:

(1) For aeroplanes with tail wheels, a normal level flight attitude.

(2) For aeroplanes with nose wheels, attitudes in which –

(i) The nose and main wheels contact the ground simultaneously; and

(ii) The main wheels contact the ground and the nose wheel is just clear of the ground.

The attitude used in sub-paragraph (a)(2)(i) of this paragraph may be used in the analysis required under sub-paragraph (a)(2)(ii) of this paragraph.

(b) A drag component of not less than 25% of the maximum vertical ground reactions (neglecting wing lift) must be properly combined with the vertical reactions. (See AMC VLA 479(b).)

#### CS-VLA 481 Tail-down landing conditions

(a) For a tail-down landing, the aeroplane is assumed to be in the following attitudes:

(1) For aeroplanes with tail wheels, an attitude in which the main and tail wheels contact the ground simultaneously.

(2) For aeroplanes with nose wheels, a stalling attitude, or the maximum angle allowing ground clearance by each part of the aeroplane, whichever is less.

(b) For aeroplanes with either tail or nose wheels, ground reactions are assumed to be vertical, with the wheels up to speed before the maximum vertical load is attained.

#### CS-VLA 483 One-wheel landing conditions

For the one-wheel landing condition, the aeroplane is assumed to be in the level attitude and to contact the ground on one side of the main landing gear. In this attitude, the ground reactions must be the same as those obtained on that side under CS-VLA 479.

#### CS-VLA 485 Side load conditions

(a) For the side load condition, the aeroplane is assumed to be in a level attitude with only the main wheels contacting the ground

## CS-VLA BOOK 1

and with the shock absorbers and tyres in their static positions.

(b) The limit vertical load factor must be 1.33, with the vertical ground reaction divided equally between the main wheels.

(c) The limit side inertia factor must be 0.83, with the side ground reaction divided between the main wheels so that –

(1) 0.5 (Mg) is acting inboard on one side; and

(2) 0.33 (Mg) is acting outboard on the other side.

### CS-VLA 493 Braked roll conditions

Under braked roll conditions, with the shock absorbers and tyres in their static positions, the following apply:

(a) The limit vertical load factor must be 1.33.

(b) The attitudes and ground contacts must be those described in CS-VLA 479 for level landings.

(c) A drag reaction equal to the vertical reaction at the wheel multiplied by a coefficient of friction of 0.8 must be applied at the ground contact point of each wheel with brakes, except that the drag reaction need not exceed the maximum value based on limiting brake torque.

### CS-VLA 497 Supplementary conditions for tail wheels

In determining the ground loads on the tail wheel and affected supporting structures, the following apply:

(a) For the obstruction load, the limit ground reaction obtained in the tail down landing condition is assumed to act up and aft through the axle at 45°. The shock absorber and tyre may be assumed to be in their static positions.

(b) For the side load, a limit vertical ground reaction equal to the static load on the tail wheel, in combination with a side component of equal magnitude, is assumed. In addition

(1) If a swivel is used, the tail wheel is assumed to be swivelled 90° to the aeroplane longitudinal axis with the resultant ground load passing through the axle;

(2) If a lock, steering device, or shimmy damper is used, the tail wheel is also assumed to be in the trailing position with the

side load acting at the ground contact point; and

(3) The shock absorber and tyre are assumed to be in their static positions.

### CS-VLA 499 Supplementary conditions for nose wheels

In determining the ground loads on nose wheels and affected supporting structures, and assuming that the shock absorbers and tyres are in their static positions, the following conditions must be met:

(a) For aft loads, the limit force components at the axle must be –

(1) A vertical component of 2.25 times the static load on the wheel; and

(2) A drag component of 0.8 times the vertical load.

(b) For forward loads, the limit force components at ground contact must be –

(1) A vertical component of 2.25 times the static load on the wheel; and

(2) A forward component of 0.4 times the vertical load.

(c) For side loads, the limit force components at the axle must be –

(1) A vertical component of 2.25 times the static load on the wheel; and

(2) A side component of 0.7 times the vertical load.

### CS-VLA 505 Supplementary conditions for skiplanes

In determining ground loads for skiplanes and assuming that the aeroplane is resting on the ground with one main ski frozen at rest and the other skis free to slide, a limit side force equal to 0.036 times the design maximum weight must be applied near the tail assembly, with a factor of safety of 1.

## WATER LOADS

### CS-VLA 521 Water load conditions

The structure of seaplanes and amphibians must be designed for water loads developed during take-off and landing with the seaplane in any attitude likely to occur in normal operation at appropriate forward and sinking velocities

## CS-VLA BOOK 1

under the most severe sea conditions likely to be encountered.

### EMERGENCY LANDING CONDITIONS

#### CS-VLA 561 General

(a) The aeroplane, although it may be damaged in emergency landing conditions, must be designed as prescribed in this paragraph to protect each occupant under those conditions.

(b) The structure must be designed to give each occupant reasonable chances of escaping injury in a minor crash landing when

(1) Proper use is made of seat belts and shoulder harnesses; and

(2) The occupant experiences the ultimate inertia forces listed below –

#### Ultimate Inertia Load Factors

Upward	3.0 g
Forward	9.0 g
Sideward	1.5 g.

(c) Each item of mass that could injure an occupant if it came loose must be designed for the load factors stated above, except that the engine mount and supporting structure must withstand 15 g forward for engines installed behind and above the seating compartment.

(d) The structure must be designed to protect the occupants in a complete turnover, assuming, in the absence of a more rational analysis –

(1) An upward ultimate inertia force of 3g; and

(2) A coefficient of friction of 0.5 at the ground.

(e) Each aeroplane with retractable landing gear must be designed to protect each occupant in a landing –

(1) With the wheels retracted;

(2) With moderate descent velocity; and

(3) Assuming, in the absence of a more rational analysis

(i) A downward ultimate inertia force of 3g; and

(ii) A coefficient of friction of 0.5 at the ground.

### FATIGUE EVALUATION

#### CS-VLA 572 Parts of structure critical to safety

(a) Each part in the primary structure the failure of which can be regarded as safety critical and which could endanger the occupants and/or lead to loss of the aeroplane must be identified. (See AMC VLA 572(a).)

(b) There must be sufficient evidence that each of the parts identified under subparagraph (a) of this paragraph has strength capabilities to achieve an adequate safe-life. (See AMC VLA 572(b).)

## CS-VLA BOOK 1

### SUBPART D – DESIGN AND CONSTRUCTION

#### GENERAL

#### CS-VLA 601 General

The suitability of each questionable design detail and part having an important bearing on safety in operations, must be established by tests.

#### CS-VLA 603 Materials and workmanship

(a) The suitability and durability of materials used for parts, the failure of which could adversely affect safety, must -

(1) Be established by experience or tests;

(2) Meet approved specifications that ensure their having the strength and other properties assumed in the design data; and

(3) Take into account the effects of environmental conditions, such as temperature and humidity, expected in service.

(b) Workmanship must be of a high standard.

#### CS-VLA 605 Fabrication methods

(a) The methods of fabrication used must produce consistently sound structures. If a fabrication process (such as gluing, spot welding, heat-treating, bonding, processing of composite materials) requires close control to reach this objective, the process must be performed under an approved process specification.

(b) Each new aeroplane fabrication method must be substantiated by a test program.

#### CS-VLA 607 Self-locking nuts

No self-locking nut may be used on any bolt subject to rotation in operation unless a non-friction locking device is used in addition to the self-locking device.

#### CS-VLA 609 Protection of structure

Each part of the structure must -

(a) Be suitably protected against deterioration or loss of strength in service due to any cause, including -

- (1) Weathering;
- (2) Corrosion; and

(3) Abrasion; and

(b) Having adequate provisions for ventilation and drainage.

#### CS-VLA 611 Accessibility

Means must be provided to allow inspection (including inspection of principal structural elements and control systems), close examination, repair, and replacement of each part requiring maintenance, adjustments for proper alignment and function, lubrication or servicing.

#### CS-VLA 613 Material strength properties and design values

(a) Material strength properties must be based on enough tests of material meeting specifications to establish design values on a statistical basis.

(b) The design values must be chosen so that the probability of any structure being understrength because of material variations is extremely remote. (See AMC VLA 613(b).)

(c) Where the temperature attained in an essential component or structure in normal operating conditions has a significant effect on strength, that effect must be taken into account. (See AMC VLA 613(c).)

#### CS-VLA 615 Design properties

(a) Design properties may be used subject to the following conditions:

(1) Where applied loads are eventually distributed through a single member within an assembly, the failure of which would result in the loss of the structural integrity of the component involved, the guaranteed minimum design mechanical properties ('A' values) must be met.

(2) Redundant structures, in which the failure of the individual elements would result in applied loads being safely distributed to other load carrying members, may be designed on the basis of the '90% probability ('B' values)'.

(3) 'A' and 'B' values are defined as follows:

(i) An 'A' is a value above which at least 99% of the population of values is expected to fall with a confidence of 95%.

(ii) A 'B' value is a value above which at least 90% of the population of values is expected to fall with a confidence of 95%.

(b) Design values greater than the guaranteed minimums required by sub-paragraph (a) of this paragraph may be used if a 'premium selection' of the material is made in which a specimen of each individual item is tested before use to determine that the actual strength properties of that particular item will equal or exceed those used in design.

(c) Material correction factors for structural items such as sheets, sheet-stringer combinations, and riveted joints, may be omitted if sufficient test data are obtained to allow a probability analysis showing that 90% or more of the elements will equal or exceed allowable selected design values. (See AMC VLA 615.)

#### **CS-VLA 619 Special factors**

The factor of safety prescribed in CS-VLA 303 must be multiplied by the highest pertinent special factors of safety prescribed in CS-VLA 621 to 625 for each part of the structure whose strength is –

(a) Uncertain;

(b) Likely to deteriorate in service before normal replacement; or

(c) Subject to appreciable variability because of uncertainties in manufacturing processes or inspection methods for composite structures, a special test factor which takes into account material variability and the effects of temperature and absorption of moisture must be used. (See AMC VLA 619.)

#### **CS-VLA 621 Casting factors**

For castings, the strength of which is substantiated by at least one static test and which are inspected by visual methods, a casting factor of 2.0 must be applied. This factor may be reduced to 1.25 providing the reduction is substantiated by tests on not less than three sample castings and all production castings are subjected to an approved visual and radiographic inspection or an approved equivalent nondestructive inspection method.

#### **CS-VLA 623 Bearing factors**

(a) Each part that has clearance (free fit), and that is subject to pounding or vibration, must

have a bearing factor large enough to provide for the effects of normal relative motion.

(b) For control surface hinges and control system joints, compliance with the factors prescribed in CS-VLA 657 and 693, respectively, meets sub-paragraph (a) of this paragraph.

#### **CS-VLA 625 Fitting factors**

For each fitting (a part or terminal used to joint one structural member to another), the following apply:

(a) For each fitting whose strength is not proven by limit and ultimate load tests in which actual stress conditions are simulated in the fitting and surrounding structures, a fitting factor of at least 1.15 must be applied to each part of –

(1) The fitting;

(2) The means of attachment; and

(3) The bearing on the joined members.

(b) No fitting factor need be used for joint designs based on comprehensive test data (such as continuous joints in metal plating, welded joints, and scarf joints in wood).

(c) For each integral fitting, the part must be treated as a fitting up to the point at which the section properties become typical of the member.

(d) For each seat, and safety belt with harness, its attachment to the structure must be shown by analysis, tests, or both, to be able to withstand the inertia forces prescribed in CS-VLA 561 multiplied by a fitting factor of 1.33.

#### **CS-VLA 627 Fatigue strength**

The structure must be designed, as far as practicable, to avoid points of stress concentration where variable stresses above the fatigue limit are likely to occur in normal service.

#### **CS-VLA 629 Flutter**

(a) It must be shown by one of the methods specified in sub-paragraph (b), (c), or (d) of this paragraph, or a combination of these methods, that the aeroplane is free from flutter, control reversal, and divergence for any condition of operation within the limit V-n envelope, and at all speeds up to the speed specified for the selected method. In addition –

## CS-VLA BOOK 1

(1) Adequate tolerances must be established for quantities which affect flutter, including speed, damping, mass balance, and control system stiffness; and

(2) The natural frequencies of main structural components must be determined by vibration tests or other approved methods. This determination is not required if (c) and (d) are both applied, and  $V_D$  is lower than 259 km/h (140 kt).

(b) A rational analysis may be used to show that the aeroplane is free from flutter, control reversal, and divergence if the analysis shows freedom from flutter for all speeds up to  $1.2 V_D$ .

(c) Flight flutter tests may be used to show that the aeroplane is free from flutter, control reversal, and divergence if it is shown by these tests that –

(1) Proper and adequate attempts to induce flutter have been made within the speed range up to  $V_D$ ;

(2) The vibratory response of the structure during the test indicates freedom from flutter;

(3) A proper margin of damping exists at  $V_D$ ; and

(4) There is no large and rapid reduction in damping as  $V_D$  is approached.

(d) Compliance with the rigidity and mass balance criteria (pages 4-12), in Airframe and Equipment Engineering Report No. 45 (as corrected) 'Simplified Flutter Prevention Criteria' (published by the Federal Aviation Administration) may be accomplished to show that the aeroplane is free from flutter, control reversal, or divergence if –

(1) The wing and aileron flutter prevention criteria, as represented by the wing torsional stiffness and aileron balance criteria, are limited in use to aeroplanes without large mass concentrations (such as engines, floats or fuel tanks in outer wing panels) along the wing span; and

(2) The aeroplane is conventional in design, and –

(i) Does not have a T-tail, boom-tail, or V-tail,

(ii) Does not have unusual mass distributions or other unconventional design features that affect the applicability of the criteria, and does not have a significant amount of sweep,

(iii) Has fixed-fin and fixed-stabiliser surfaces.

(e) For longitudinal, lateral and directional controls, freedom from flutter, control reversal, and divergence up to  $V_D$  must be shown after the failure, malfunction, or disconnection of any single element in any tab control system.

## WINGS

### CS-VLA 641 Proof of strength

The strength of stressed-skin wings must be proven by load tests or by combined structural analysis and load tests.

## CONTROL SURFACES

### CS-VLA 651 Proof of strength

(a) Limit load tests of control surfaces are required. These tests must include the horn or fitting to which the control system is attached.

(b) In structural analyses, rigging loads due to wire bracing must be accounted for in a rational or conservative manner.

### CS-VLA 655 Installation

(a) Movable tail surfaces must be installed so that there is no interference between any surfaces or their bracing when one surface is held in its extreme position and the others are operated through their full angular movement.

(b) If an adjustable stabiliser is used, it must have stops that will limit its range of travel to that allowing safe flight and landing.

### CS-VLA 657 Hinges

(a) Control surface hinges, except ball and roller bearing hinges, must have a factor of safety of not less than 6-67 with respect to the ultimate bearing strength of the softest material used as a bearing.

(b) For ball or roller bearing hinges, the approved rating of the bearing may not be exceeded.

(c) Hinges must have enough strength and rigidity for loads parallel to the hinge line.

### CS-VLA 659 Mass balance

The supporting structure and the attachment of concentrated mass balance weights used on

control surfaces must be designed for limit loads corresponding to –

- (a) 24 g normal to the plane of the control surface;
- (b) 12 g fore and aft; and
- (c) 12 g parallel to the hinge line.

## CONTROL SYSTEMS

### CS-VLA 671 General

(a) Each control must operate easily, smoothly, and positively enough to allow proper performance of its functions.

(b) Controls must be arranged and identified to provide for convenience in operation and to prevent the possibility of confusion and subsequent inadvertent operation.

### CS-VLA 673 Primary flight controls

(a) Primary flight controls are those used by the pilot for the immediate control of pitch, roll and yaw.

(b) The design of the primary flight controls must be such as to minimise the likelihood of failure of any connecting or transmitting element in the control system that could result in loss of control of any axis.

### CS-VLA 675 Stops

(a) Each control system must have stops that positively limit the range of motion of each movable aerodynamic surface controlled by the system.

(b) Each stop must be located so that wear, slackness, or take up adjustments will not adversely affect the control characteristics of the aeroplane because of a change in the range of surface travel.

(c) Each stop must be able to withstand any loads corresponding in the design conditions for the control system.

### CS-VLA 677 Trim systems

(a) Proper precautions must be taken to prevent inadvertent, improper, or abrupt trim tab operation. There must be means near the trim control to indicate to the pilot the direction of trim control movement relative to aeroplane motion. In addition, there must be means to indicate to the pilot the position of the trim

device with respect to the range of adjustment. This means must be visible to the pilot and must be located and designed to prevent confusion.

(b) Tab controls must be irreversible unless the tab is properly balanced and has no unsafe flutter characteristics. Irreversible tab systems must have adequate rigidity and reliability in the portion of the system from the tab to the attachment of the irreversible unit to the aeroplane structure.

### CS-VLA 679 Control system locks

If there is a device to lock the control system on the ground or water, there must be means to –

- (a) Give unmistakable warning to the pilot when the lock is engaged; and
- (b) Prevent the lock from engaging in flight.

### CS-VLA 681 Limit load static tests

(a) Compliance with the limit load requirements must be shown by tests in which –

- (1) The direction of the test loads produces the most severe loading in the control system; and
- (2) Each fitting, pulley, and bracket used in attaching the system to the main structure is included.

(b) Compliance must be shown (by analyses or individual load tests) with the special factor requirements for control system joints subject to angular motion.

### CS-VLA 683 Operation tests

(a) It must be shown by operation tests that, when the controls are operated from the pilot compartment with the system loaded as prescribed in subparagraph (b) of this paragraph, the system is free from –

- (1) Jamming;
- (2) Excessive friction; and
- (3) Excessive deflection.

(b) The prescribed test loads are –

- (1) For the entire system, loads corresponding to the limit air loads on the appropriate surface, or the limit pilot forces in CS-VLA 397 (b), whichever are less; and
- (2) For secondary controls, loads not less than those corresponding to the maximum pilot effort established under CS-VLA 405.

**CS-VLA 685 Control system details**

(a) Each detail of each control system must be designed and installed to prevent jamming, chafing, and interference from cargo, passengers, loose objects, or the freezing of moisture.

(b) There must be means in the cockpit to prevent the entry of foreign objects into places where they would jam the system.

(c) There must be means to prevent the slapping of cables or tubes against other parts.

(d) Each element of the flight control system must have design features, or must be distinctively and permanently marked, to minimize the possibility of incorrect assembly that could result in malfunctioning of the control system.

(d) Clevis pins subject to load or motion and retained only by split-pins may not be used in the control system.

(e) Turnbuckles must be attached to parts having angular motion in a manner that will positively prevent binding throughout the range of travel.

(f) Tab control cables are not part of the primary control system and may be less than 3 mm diameter in aeroplanes that are safely controllable with the tabs in the most adverse positions.

**CS-VLA 687 Spring devices**

The reliability of any spring device used in the control system must be established by tests simulating service conditions unless failure of the spring will not cause flutter or unsafe flight characteristics.

**CS-VLA 693 Joints**

Control system joints (in push-pull systems) that are subject to angular motion, except those in ball and roller bearing systems, must have a special factor of safety of not less than 3.33 with respect to the ultimate bearing strength of the softest material used as a bearing. This factor may be reduced to 2.0 for joints in cable control systems. For ball or roller bearings, the approved ratings may not be exceeded.

**CS-VLA 689 Cable systems**

(a) Each cable, cable fitting, turnbuckle, splice, and pulley used must meet approved specifications. In addition –

(1) No cable smaller than 3 mm diameter may be used in primary control systems;

(2) Each cable system must be designed so that there will be no hazardous change in cable tension throughout the range of travel under operating conditions and temperature variations; and

(3) There must be means for visual inspection at each fairlead, pulley, end-fitting and turnbuckle.

(b) Each kind and size of pulley must correspond to the cable with which it is used. Each pulley must have closely fitted guards to prevent the cables from being misplaced or fouled, even when slack. Each pulley must lie in the plane passing through the cable so that the cable does not rub against the pulley flange.

(c) Fairleads must be installed so that they do not cause a change in cable direction of more than 3°.

**CS-VLA 697 Wing flap controls**

(a) Each wing flap control must be designed so that, when the flap has been placed position upon which compliance with the performance requirements is based, the flap will not splice, and pulley used move from that position unless the control is adjusted or is moved by the automatic operation of a flap load limiting device

(b) The rate of movement of the flaps in response to the operation of the pilot's control or automatic device must give satisfactory flight and performance characteristics under steady or changing conditions of airspeed, engine power, and attitude.

**CS-VLA 699 Wing flap position indicator**

There must be a wing flap position indicator for –

(a) Flap installations with only the retracted and fully extended position, unless –

(1) A direct operating mechanism provides a sense of 'feel' and position (such as when a mechanical linkage is employed); or

(2) The flap position is readily determined without seriously detracting from



## CS-VLA BOOK 1

other piloting duties under any flight condition; and

(b) Flap installation with intermediate flap positions if –

(1) Any flap position other than retracted or fully extended is used to show compliance with the performance requirements of this part; and

(2) The flap installation does not meet the requirements of sub-paragraph (a)(1) of this paragraph.

### CS-VLA 701 Flap interconnection

The motion of flaps on opposite sides of the plane of symmetry must be synchronised by the mechanical interconnection.

### CS-VLA 723 Shock absorption tests

(a) It must be shown that the limit load factors selected for design in accordance with CS-VLA 473 will not be exceeded. This must be shown by energy absorption tests except that analysis may be used for

(1) Increases in previously approved take-off and landing weights,

(2) Landing gears previously approved wheel type aeroplanes with similar weights and performances

(3) Landing gears using a steel or composite material spring or any other energy absorption element where the shock absorption characteristics are not essentially affected by the rate of compression or tension,

(4) Landing gears for which adequate experience and substantiating data are available.

(b) The landing gear may not fail, but may yield, in a test showing its reserved energy absorption capacity, simulating a descent velocity of 1.2 times the limit descent velocity, assuming wing lift equal to the weight of the aeroplane. The test may be replaced by an analysis in the same cases as sub-paragraphs (a)(1) to (a)(4) of this paragraph.

### CS-VLA 725 Limit drop tests

(a) If compliance with CS-VLA 723 (a) is shown by free drop tests, these tests must be made on the complete aeroplane, or on units consisting of wheel, tyre, and shock absorber, in

their proper relation, from free drop heights not less than those determined by the following formula:

$$h = 0.0132 (Mg/S)^{1/2}$$

However, the free drop height may not be less than 0.235 m and need not be more than 0.475 m.

(b) If the effect of wing lift is provided for in free drop tests, the landing gear must be dropped with an effective weight equal to –

$$M_e = M \left[ \frac{h + (1-L)d}{h+d} \right]$$

where –

$M_e$  = the effective weight to be used in the drop test (kg);

$h$  = specified free drop height (m);

$d$  = deflection under impact of the tyre (at the approved inflation pressure) plus the vertical component of the axle travel relative to the drop mass (m);

$M$  =  $M_M$  for main gear units (kg), equal to the static weight on that unit with the aeroplane in the level attitude (with the nose wheel clear in the case of nose wheel type aeroplanes);

$M$  =  $M_T$  for tail gear units (kg), equal to the static weight on the tail unit with the aeroplane in the tail down attitude;

$M$  =  $M_N$  for nose wheel units (kg), equal to the vertical component of the static reaction that would exist at the nose wheel, assuming that the mass of the aeroplane acts at the centre of gravity and exerts a force of 1.0 g downward and 0.33 g forward;

$L$  = the ratio of the assumed wing lift to the aeroplane weight, but not more than 0.667; and

$g$  = the acceleration due to gravity ( $m/s^2$ ).

(c) The limit inertia load factor must be determined in a rational or conservative manner, during the drop test, using a landing gear unit attitude, and applied drag loads, that represent the landing conditions.

(d) The value of  $d$  used in the computation of  $M_e$  in sub-paragraph (b) of this paragraph may not exceed the value actually obtained in the drop test.

(e) The limit inertia load factor must be determined from the drop test in sub-paragraph

(b) of this paragraph according to the following formula:

$$n = n_j \frac{M_e}{M} + L$$

where –

$n_j$  = the load factor developed in the drop test (that is, the acceleration (dv/dt) in g recorded in the drop test) plus 1.0; and

$M_e$ ,  $M$  and  $L$  are the same as in the drop test computation.

(f) The value of  $n$  determined in accordance with sub-paragraph (e) of this paragraph may not be more than the limit inertia load factor used in the landing conditions in CS-VLA 473.

**CS-VLA 726 Ground load dynamic tests**

(a) If compliance with the ground load requirements of CS-VLA 479 to 483 is shown dynamically by drop test, one drop test must be conducted that meets CS-VLA 725 except that the drop height must be –

- (1) 2.25 times the drop height prescribed in CS-VLA 725 (a); or
- (2) Sufficient to develop 1.5 times the limit load factor.

(b) The critical landing condition for each of the design conditions specified in CS-VLA 479 to 483 must be used for proof of strength.

**CS-VLA 727 Reserve energy absorption**

(a) If compliance with the reserve energy absorption requirement in CS-VLA 723 (b) is shown by free drop tests, the drop height may not be less than 1.44 times that specified in CS-VLA 725.

(b) If the effect of wing lift is provided for, the unit must be dropped with an effective mass equal to  $M_e = M \left( \frac{h}{h+d} \right)$ , when the symbols and other details are the same as CS-VLA 725.

**CS-VLA 729 Landing gear extension and retraction system**

(a) *General.* For aeroplanes with retractable landing gear, the following apply:

(1) Each landing gear retracting mechanism and its supporting structure must be designed for maximum flight load factors with the gear retracted and must be designed for the combination of friction, inertia, brake torque, and air loads, occurring during retraction at any airspeed up to 1.6  $V_{S1}$  with flaps retracted, and for any load factor up to those specified in CS-VLA 345 for the flaps-extended condition.

(2) The landing gear and retracting mechanism, including the wheel well doors, must withstand flight loads, including loads resulting from all yawing conditions specified in CS-VLA 351, with the landing gear extended at any speed up to at least 1.6  $V_{S1}$  with the flaps retracted.

(b) *Landing gear lock.* There must be positive means to keep the landing gear extended.

(c) *Emergency operation.* For a landplane having retractable landing gear that cannot be extended manually, there must be means to extend the landing gear in the event of either –

- (1) Any reasonably probable failure in the normal landing gear operation system; or
- (2) Any reasonably probable failure in a power source that would prevent the operation of the normal landing gear operation system.

(d) *Operation test.* The proper functioning of the retracting mechanism must be shown by operation tests up to  $V_{LO}$ .

(e) *Position indicator.* If a retractable landing gear is used, there must be a landing gear position indicator (as well as necessary switches to actuate the indicator) or other means to inform the pilot that the gear is secured in the extended (or retracted) position. If switches are used, they must be located and coupled-to the landing gear mechanical system in a manner that prevents an erroneous indication of either ‘down and locked’ if the landing gear is not in the fully extended position, or of ‘up and locked’ if the landing gear is not in the fully retracted position. The switches may be located where they are operated by the actual landing gear locking latch or device.

(f) *Landing gear warning.* For landplanes, the following aural or equally effective landing gear warning devices must be provided:

- (1) A device that functions continuously when the throttle is closed if the landing gear is not fully extended and locked.

A throttle stop may not be used in place of an aural device.

(2) A device that functions continuously when the wing flaps are extended to or beyond the approach flap position, using a normal landing procedure, if the landing gear is not fully extended and locked. The flap position sensing unit may be installed at any suitable location. The system for this device may use any part of the system (including the aural warning device) for the device required in subparagraph (f)(1) of this paragraph.

### CS-VLA 731 Wheels

(a) Each main and nose wheel must be approved.

(b) The maximum static load rating of each wheel may not be less than the corresponding static ground reaction with –

- (1) Design maximum weight; and
- (2) Critical centre or gravity.

(c) The maximum limit load rating of each wheel must equal or exceed the maximum radial limit load determined under the applicable ground load requirements.

### CS-VLA 733 Tyres

(a) Each landing gear wheel must have a tyre whose tyre rating (approved by the Agency) is not exceeded –

(1) By a load on each main wheel tyre equal to the corresponding static ground reaction under the design maximum weight and critical centre of gravity; and

(2) By a load on nose wheel tyres (to be compared with the dynamic rating established for such tyres) equal to the reaction obtained at the nose wheel, assuming the mass of the aeroplane to be contracted at the most critical centre of gravity and exerting a force of 1.0 Mg downward and 0.21 Mg forward (where Mg is the design maximum weight), with the reactions distributed to the nose and main wheels by the principles of statics, and with the drag reaction at the ground applied only at wheels with brakes.

(b) Each tyre installed on a retractable landing gear system must, at the maximum size of the tyre type expected in service, have a clearance to surrounding structure and systems

that is adequate to prevent contact between the tyre and any part of the structure or systems.

### CS-VLA 735 Brakes

(a) Brakes must be provided so that the brake kinetic energy capacity rating of each main wheel brake assembly is not less than the kinetic energy absorption requirements determined under either of the following methods:

(1) The brake kinetic energy absorption requirements must be based on a conservative rational analysis of the sequence of events expected during landing at the maximum weight.

(2) Instead of a rational analysis, the kinetic energy absorption requirements for each main wheel brake assembly may be derived from the following formula:

$$KE = \frac{1}{2}MV^2/N$$

where –

KE = kinetic energy per wheel (Joules);

M = mass at maximum weight (kg);

V = aeroplane speed in m/s. V must be not less than  $V_{S0}$ , the power-off stalling speed of the aeroplane at sea level, at the design landing weight, and in the landing configuration; and

N = number of main wheels with brakes.

(b) Brakes must be able to prevent the wheels from rolling on a paved runway with maximum take-off power but need not prevent movement of the aeroplane with wheels locked.

### CS-VLA 737 Skis

Each ski must be approved. The maximum limit load rating of each ski must equal or exceed the maximum limit load determined under the applicable ground load requirements.

## FLOATS AND HULLS

### CS-VLA 751 Main float buoyancy

(a) Each main float must have –

(1) A buoyancy of 80% in excess of the maximum weight which that float is expected to carry in supporting the maximum

## CS-VLA BOOK 1

weight of the seaplane or amphibian in fresh water; and

(2) Enough watertight compartments to provide reasonable assurance that the seaplane or amphibian will stay afloat if any two compartments of the main floats are flooded.

(b) Each main float must contain at least four watertight compartments approximately equal in volume.

### **CS-VLA 753 Main float design**

Each seaplane main float must be approved and must meet the requirements of CS-VLA 521.

### **CS-VLA 757 Auxiliary floats**

Auxiliary floats must be arranged so that when completely submerged in fresh water, they provide a righting moment of at least 1.5 times the upsetting moment caused by the seaplane or amphibian being tilted.

## **PERSONNEL AND CARGO ACCOMMODATIONS**

### **CS-VLA 771 Pilot compartment**

(a) The pilot compartment and its equipment must allow the pilot to perform his duties without unreasonable concentration or fatigue.

(b) The aerodynamic controls listed in CS-VLA 779, excluding cables and control rods, must be located with respect to the propeller so that no part of the pilot or the controls lies in the region between the plane of rotation of propeller and the surface generated by a line passing through the centre of the propeller hub making an angle of 5° forward or aft of the plane of rotation of the propeller.

### **CS-VLA 773 Pilot compartment view**

The pilot compartment must be free from glare and reflections that could interfere with the pilot's vision, and designed so that –

(a) The pilot's view is sufficiently extensive, clear, and undistorted, for safe operation;

(b) The pilot is protected from the elements so that moderate rain conditions do not unduly

impair his view of the flight path in normal flight and while landing; and

(c) Internal fogging of the windows covered under sub-paragraph (a) of this paragraph can be easily cleared by the pilot unless means are provided to prevent fogging. (See AMC VLA 773.)

### **CS-VLA 775 Windshields and windows**

(a) Windshields and windows must be constructed of a material that will not result in serious injuries due to splintering. (See AMC VLA 775 (a).)

(b) Windshields and side windows of the canopy must have a luminous transmittance value of at least 70% and must not significantly alter the natural colours.

### **CS-VLA 777 Cockpit controls**

(a) Each cockpit control must be located to provide convenient operation, and to prevent confusion and inadvertent operation.

(b) The controls must be located and arranged so that the pilot, when strapped in his seat, has full and unrestricted movement of each control without interference from either his clothing (including winter clothing) or from the cockpit structure.

(c) Powerplant controls must be located –

(1) For tandem seated aeroplanes, on the left side console or instrument panel;

(2) For other aeroplanes, at or near the centre of the cockpit, on the pedestal, instrument panel, or overhead; and

(3) For aeroplanes, with side-by-side pilot seats and with two sets of Powerplant controls, on left and right consoles.

(d) The control location order from left to right must be power lever, propeller (rpm control), and mixture control. Power levers must be at least 2.54cm higher or longer to make them more prominent than propeller (rpm control) or mixture controls. Carburettor heat or alternate air control must be to the left of the throttle or at least 20.3cm from the mixture control when located other than on a pedestal. Carburettor heat or alternate air control, when located on a pedestal must be aft or below the power lever. Supercharger controls must be located below or aft of the propeller controls. Aeroplanes with tandem seating or single-seat aeroplanes may

utilise control locations on the left side of the cabin compartment; however, location order from left to right must be power lever, propeller (rpm control) and mixture control.

(e) Wing flap and auxiliary lift device controls must be located –

(1) Centrally, or to the right of pedestal or powerplant throttle control centreline; and

(2) Far enough away from the landing gear control to avoid confusion.

(f) The landing gear control must be located to the left of the throttle centreline or pedestal centreline.

(g) Each fuel feed selector control must comply with CS-VLA 995 and be located and arranged so that the pilot can see and reach it without moving any seat or primary flight control when his seat is at any position in which it can be placed.

(1) For a mechanical fuel selector –

(i) The indication of the selected fuel valve position must be by means of a pointer and must provide positive identification and feel (detent, etc.) of the selected position.

(ii) The position indicator pointer must be located at the part of the handle that is the maximum dimension of the handle measured from the centre of rotation.

(2) For electrical or electronic fuel selector–

(i) Digital controls or electrical switches must be properly labelled.

(ii) Means must be provided to indicate to, the flight crew the tank or function selected. Selector switch position is not acceptable as a means of indication. The ‘off or ‘closed’ position must be indicated in red.

(3) If the fuel valve selector handle or electrical or digital selection is also a fuel shut-off selector, the off position marking must be coloured red. If a separate emergency shut-off means is provided, it also must be coloured red. (See AMC VLA 777.)

**CS-VLA779 Motion and effect of cockpit controls**

Cockpit controls must be designed so that they operate in accordance with the following movement and actuation:

(a) Aerodynamic controls –

*Motion and effect*

(1) *Primary controls:*

Aileron----- Right (clockwise) for right wing down.

Elevator----- Rearward for nose up.

Rudder ----- Right pedal forward for nose right.

(2) *Secondary controls:*

Flaps(or auxiliary lift devices) Forward or up for flaps up or auxiliary device stowed; rearward or down for flaps down or auxiliary device deployed.

Trim tabs (or equivalent) Switch motion or mechanical rotation of control to produce similar rotation of the aeroplane about an axis parallel to the axis control. Axis of roll trim control may be displaced to accommodate comfortable actuation by the pilot. Direction of pilot’s hand movement must be in the same sense as aeroplane response for rudder trim if only a portion of a rotational element is accessible.

(b) Powerplant and auxiliary controls -

*Motion and effect*

(1) *Powerplant controls:*

Power (thrust) lever. Forward to increase forward thrust and rearward to increase rearward thrust.

Propellers - Forward to increase rpm.  
Mixture---- Forward or upward for rich.

Carburettor, air heat or alternate air.	Forward or upward for cold.
Super charger.	Forward or upward for low blower.
Turbosuper-chargers.	Forward, upward or clockwise to increase pressure.
Rotary controls.	Clockwise from off to full on.

(2) *Auxiliary controls:*

Fuel tank selector	Right for right tanks, left for left tanks.
Landing gear.	Down to extend.
Speed brakes.	Aft to extend.

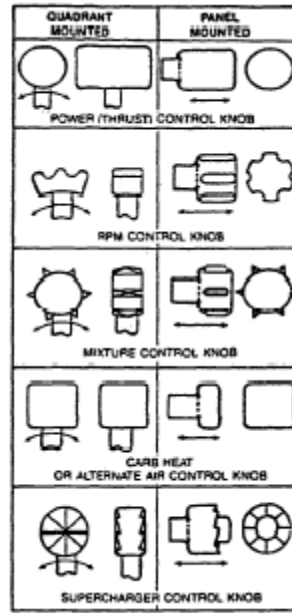

**CS-VLA 781 Cockpit control knob shape**

(a) Landing gear and flap control knobs must conform to the general shapes (but not necessarily the exact sizes or specific proportions) in the following figure:

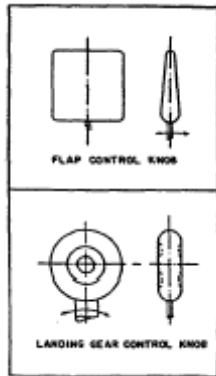

(b) Powerplant control knobs must conform to the general shapes (but not necessarily the exact sizes or specific proportions) in the following figure:

**CS-VLA 783 Exits**

No exit may be located with respect to any propeller disc so as to endanger persons using that exit.

[Amdt VLA/1]

**CS-VLA 785 Seats, safety belts, and harnesses**

(a) Each seat and its supporting structure, must be designed for occupants weighing at least 86 kg, and for the maximum load factors corresponding to the specified flight and ground load conditions, including the emergency landing conditions prescribed in CS-VLA 561.

(b) Each safety belt with shoulder harness, must be approved. Each safety belt with shoulder harness must be equipped with a metal to metal latching device.

(c) Each pilot seat must be designed for the reactions resulting from the application of pilot forces to the primary flight controls, as prescribed in CS-VLA 395.

(d) Proof of compliance with the strength and deformation requirements of this paragraph for seats, approved as part of the type design and for seat installations may be shown by –

(1) Structural analysis, if the structure conforms to conventional aeroplane types for which existing methods of analysis are known to be reliable;

(2) A combination of structural analysis and static load tests to limit loads; or

(3) Static load tests to ultimate loads.

(e) Each occupant must be protected from serious head injury when he experiences the inertia forces prescribed in CS-VLA 561 (b)(2) by a safety belt and shoulder harness that is designed to prevent the head from contacting any injurious object. (See AMC VLA 785 (e).)

(f) Each shoulder harness installed at a pilot seat must allow the pilot, when seated and with his safety belt and shoulder harness fastened, to perform all functions necessary for flight operations.

(g) There must be a means to secure each safety belt and shoulder harness, when not in use, so as to prevent interference with the operation of the aeroplane and with rapid egress in an emergency.

(h) Each seat track must be fitted with stops to prevent the seat from sliding off the track.

(i) The cabin area surrounding each seat, including the structure, interior walls, instrument panel, control wheel, pedals, and seats, within striking distance of the occupant's head or torso (with the safety belt and shoulder harness fastened), must be free of potentially injurious objects, sharp edges, protuberances, and hard surfaces. If energy absorbing designs or devices are used to meet this requirement they must protect the occupant from serious injury when the occupant experiences the ultimate inertia forces prescribed in CS-VLA 561 (b)(2).

**CS-VLA 787      Baggage compartments**

(a) Each baggage compartment must be designed for its placarded maximum weight of contents and for the critical load distributions at the appropriate maximum load factors corresponding to the flight and ground load conditions of this document.

(b) There must be means to prevent the contents of any baggage compartment from becoming a hazard by shifting, and to protect any controls, wiring, lines, equipment or accessories whose damage or failure would affect safe operations.

(c) Baggage compartments must be constructed of materials which are at least flame resistant.

(d) Designs which provide for baggage to be carried must have means to protect the

occupants from injury under the ultimate inertia forces specified in CS-VLA 561 (b)(2).

(e) If there is no structure between baggage and occupant compartments the baggage items located behind the occupants and those which might become a hazard in a crash must be secured for 1.33 x 9 g.

**CS-VLA 807      Emergency exits**

(a) The aeroplane must be so designed that unimpeded and rapid escape is possible in any normal and crash attitude. (See AMC VLA 807(a))

(b) The opening system must be designed for simple and easy operation. It must function rapidly and be designed so that it can be operated by each occupant strapped in his seat, and also from outside the cockpit. Reasonable provisions must be provided to prevent jamming by fuselage deformation.

[Amdt VLA./1]

**CS-VLA 831      Ventilation**

The personnel compartment must be suitably ventilated. Carbon monoxide concentration may not exceed one part in 20 000 parts of air.

**FIRE PROTECTION**

**CS-VLA 853      Compartment interiors**

For the personnel compartment –

(a) The materials must be at least flame resistant.

(b) [Reserved.]

(c) If smoking is to be prohibited, there must be a placard so stating, and if smoking is to be allowed there must be an adequate number of self-contained removable ashtrays.

(d) Lines, tanks, or equipment containing fuel, oil, or other flammable fluids may not be installed in the personnel Compartment unless adequately shielded, isolated, or otherwise protected so that any breakage or failure of such an item would not create a hazard.

(e) Aeroplane materials located on the cabin side of the firewall must be self-extinguishing or be located at such a distance from the firewall, or otherwise protected, so that ignition will not occur if the firewall is subjected to a flame temperature of not less than 1100°C for 15 minutes. This may be shown by test or analysis.

For self-extinguishing materials (except electrical wire and cable insulation and small parts that the Agency finds would not contribute significantly to the propagation of a fire), a vertical self-extinguishing test must be conducted in accordance with Appendix F or an equivalent method approved by the Agency. The average burn length of the material may not exceed 17 cm and the average flame time after removal of the flame source may not exceed 15 seconds. Drippings from the material test specimen may not continue to flame for more than an average of 3 seconds after failing.

**CS-VLA 857      Electrical bonding**

(a) Electrical continuity must be provided to prevent the existence of difference of potential between components of the powerplant including fuel and other tanks, and other significant parts of the aeroplane which are electrically conductive.

(b) The cross-sectional areas of bonding connectors if made from copper must not be less than 1.3 mm\*.

(c) There must be provisions for electrically bonding the aeroplane to the ground fuelling equipment.

**CS-VLA 863      Flammable fluid fire protection**

In each area where flammable fluids or vapours might escape by leakage from a fluid system, there must be means in the form of adequate segregation, ventilation and drainage, to minimize the probability of ignition of the fluids and vapours and the resultant hazard if ignition should occur.

**CS-VLA865      Fire protection of flight controls and other flight structure**

Flight controls, engine mounts, and other flight structure located in the engine compartment must be constructed of fireproof material or shielded so that they will withstand the effect of a fire.

**MISCELLANEOUS**

**CS-VLA 871      Levelling means**

There must be means for determining when the aeroplane is in a level position on the ground.



**CS-VLA BOOK 1**

# CS-VLA BOOK 1

## SUBPART E – POWERPLANT

### GENERAL

#### CS-VLA 901 Installation

(a) For the purpose of this CS-VLA the aeroplane powerplant installation includes each component that –

- (1) Is necessary for propulsion; and
- (2) Affects the safety of the propulsive unit.

(b) The powerplant must be constructed, arranged, and installed to –

(1) Ensure safe operation to the maximum altitude for which approval is requested.

(2) Be accessible for necessary inspections and maintenance.

(c) Engine cowls and nacelles must be easily removable or openable by the pilot to provide adequate access to and exposure of the engine compartment for preflight checks.

(d) The installation must comply with –

(1) The installation instructions provided by the engine manufacturer.

(2) The applicable provisions of this subpart.

#### CS-VLA 903 Engine

(a) The engine must meet the specifications of CS-22 Subpart H.

(b) *Restart capability.* An altitude and airspeed envelope must be established for the aeroplane for in-flight engine restarting and the installed engine must have a restart capability within that envelope.

#### CS-VLA 905 Propeller

(a) The propeller must meet the specifications of CS-22 Subpart J.

(b) Engine power and propeller shaft rotational speed may not exceed the limits for which the propeller is certificated or approved.

#### CS-VLA 907 Propeller vibration

(a) Each propeller with metal blades or highly stressed metal components must be shown to have vibration stresses, in normal operating conditions, that do not exceed values that have been shown by the propeller manufacturer to be

safe for continuous operation. This must be shown by –

(1) Measurement of stresses through direct testing of the propeller;

(2) Comparison with similar installations for which these measurements have been made; or

(3) Any other acceptable test method or service experience that proves the safety of the installation.

(b) Proof of safe vibration characteristics for any type of propeller, except for conventional, fixed-pitch wooden propellers, must be shown where necessary.

#### CS-VLA 909 Supercharger

(a) The supercharger must be approved under the engine type certificate.

(b) Control system malfunctions, vibrations, and abnormal speeds and temperatures expected in service may not damage the supercharger compressor or turbine.

(c) The supercharger case must be able to contain fragments of a compressor or turbine that fails at the highest speed that is obtainable with normal speed control devices inoperative.

#### CS-VLA 925 Propeller clearance

Unless smaller clearances are substantiated, propeller clearances with the aeroplane at maximum weight, with the most adverse centre of gravity, and with the propeller in the most adverse pitch position, may not be less than the following:

(a) *Ground clearance.* There must be a clearance of at least 180 mm (for each aeroplane with nose wheel landing gear) or 230 mm (for each aeroplane with tail wheel landing gear) between each propeller and the ground with the landing gear statically deflected and in the level, normal take-off, or taxiing attitude, whichever is most critical. In addition, for each aeroplane with conventional landing gear struts using fluid or mechanical means for absorbing landing shocks, there must be positive clearance between the propeller and the ground in the level take-off attitude with the critical tyre completely deflated and the corresponding landing gear strut bottomed. Positive clearance for aeroplanes using leaf spring struts is shown with a deflection corresponding to 1.5 g.

## CS-VLA BOOK 1

(b) *Water clearance.* There must be a clearance of at least 46 mm between each propeller and the water, unless compliance with CS-VLA 239 can be shown with a lesser clearance.

(c) *Structural clearance.* There must be –

(1) At least 26 mm radial clearance between the blade tips and the aeroplane structure, plus any additional radial Clearance necessary to prevent harmful vibration;

(2) At least 13 mm longitudinal clearance between the propeller blades or cuffs and stationary parts of the aeroplane; and

(3) Positive clearance between other rotating parts of the propeller or spinner and stationary parts of the aeroplane.

(d) Clearance from occupant(s). There must be adequate clearance between the occupant(s) and the propeller such that it is not possible for the occupant(s), when seated and strapped in, to contact the propeller inadvertently.

### CS-VLA 943 Negative acceleration

No hazardous malfunction of an engine, or any component or system associated with the powerplant may occur when the aeroplane is operated at negative accelerations of short duration such as may be caused by a gust. (See AMC VLA 943.)

## FUEL SYSTEM

### CS-VLA 951 General

(a) Each fuel system must be constructed and arranged to ensure a flow of fuel at a rate and pressure established for proper engine functioning under any normal operating condition, and must be arranged to prevent the introduction of air into the system.

(b) Each fuel system must be arranged so that no fuel pump can draw fuel from more than one tank at a time. Gravity feed systems may not supply fuel to the engine from more than one tank at a time, unless the airspaces are interconnected in a manner to ensure that all interconnected tanks feed equally.

### CS-VLA 955 Fuel flow

(a) *General.* The ability of the fuel system to provide fuel at the rates specified in this paragraph and at a pressure sufficient for proper

carburettor operation must be shown in the attitude that is most critical with respect to fuel feed and quantity of unusable fuel. These conditions may be simulated in a suitable mockup. In addition -

(1) The quantity of fuel in the tank may not exceed the amount established as the unusable fuel supply for that tank under CS-VLA 959 plus that necessary to show compliance with this paragraph; and

(2) If there is a fuel flowmeter, it must be blocked during the flow test and the fuel must flow through the meter bypass.

(b) *Gravity systems.* The fuel flow rate for gravity systems (main and reserve supply) must be 150% of the take-off fuel consumption of the engine.

(c) *Pump systems.* The fuel flow rate for each pump system (main and reserve supply) must be 125% of the take-off fuel consumption of the engine at the maximum power established for take-off. This flow rate is required for each primary engine driven pump and each emergency pump, and must be available when the pump is running as it would during take-off.

(d) *Multiple fuel tanks.* If the engine can be supplied with fuel from more than one tank, it must be possible, in level flight, to regain full power and fuel pressure to that engine in not more than 10 seconds after switching to any full tank after engine malfunctioning due to fuel depletion becomes apparent while the engine is being supplied from any other tank.

### CS-VLA 957 Flow between interconnected tanks

It must be impossible, in a gravity feed system with interconnected tank outlets, for enough fuel to flow between the tanks to cause an overflow of fuel from any tank vent under the conditions in CS-VLA 959, except that full tanks must be used.

### CS-VLA 959 Unusable fuel supply

The unusable fuel supply for each tank must be established as not less than that quantity at which the first evidence of malfunctioning occurs under the most adverse fuel feed condition occurring under each intended operation and flight manoeuvre involving that tank. Fuel system component failures need not be considered.

## CS-VLA BOOK 1

### CS-VLA 961 Fuel system hot weather operation

Each fuel system must be free from vapour lock when using fuel at a temperature of 43°C under critical operating conditions, and with the most critical fuel for which certification is requested.

### CS-VLA 963 Fuel tanks: general

(a) Each fuel tank must be able to withstand, without failure, the vibration, inertia, fluid, and structural loads that it may be subjected to in operation.

(b) Each flexible fuel tank liner must be of an acceptable kind.

(c) Each integral fuel tank must have adequate facilities for interior inspection and repair.

### CS-VLA 965 Fuel tank tests

Each fuel tank must be able to withstand the following pressures without failure or leakage:

(a) For each conventional metal tank and non-metallic tank with walls not supported by the aeroplane structure, a pressure of 24 kPa.

(b) For each integral tank, the pressure developed during the maximum limit acceleration of the aeroplane with a full tank, with simultaneous application of the critical limit structural loads.

(c) For each non-metallic tank with walls supported by the aeroplane structure and constructed in an acceptable manner using acceptable basic tank material, and with actual or simulated support conditions, a pressure of 14 kPa, for the first tank of a specific design. The supporting structure must be designed for the critical loads occurring in the flight or landing strength conditions combined with the fuel pressure loads resulting from the corresponding accelerations.

### CS-VLA 967 Fuel tank installation

(a) Each fuel tank must be supported so that tank loads are not concentrated. In addition --

(1) There must be pads, if necessary, to prevent chafing between each tank and its supports;

(2) Padding must be non-absorbent or treated to prevent the absorption of fuel;

(3) If flexible tank liner is used, it must be supported so that it is not required to withstand fluid loads;

(4) Interior surfaces adjacent to the liner must be smooth and free from projections that could cause wear, unless --

(i) Provisions are made for protection of the liner at those points; or

(ii) The construction of the liner itself provides such protection;

(5) A positive pressure must be maintained within the vapour space of each bladder cell under all conditions of operation except for a particular condition for which it is shown that a zero or negative pressure will not cause the bladder cell to collapse; and

(6) Siphoning of fuel (other than minor spillage) or collapse of bladder fuel cells may not result from improper securing or loss of the fuel filler cap.

(b) Each tank compartment must be ventilated and drained to prevent the accumulation of flammable fluids or vapours. Each compartment adjacent to a tank that is an integral part of the aeroplane structure must also be ventilated and drained.

(c) No fuel tank may be on the engine side of the firewall. There must be at least 13 mm of clearance between the fuel tank and the firewall. No part of the engine nacelle skin that lies immediately behind a major air opening from the engine compartment may act as the wall of an integral tank.

(d) If a fuel tank is installed in the personnel compartment it must be isolated by fume and fuel-proof enclosures that are drained and vented to the exterior of the aeroplane. A bladder type fuel cell, if used, must have a retaining shell at least equivalent to a metal fuel tank in structural integrity.

(e) Fuel tanks and fuel system components must be designed, located, and installed so as to retain fuel -

(1) Under the inertia forces prescribed for the emergency landing conditions in CS-VLA 561; and

(2) Under conditions likely to occur when an aeroplane lands on a paved runway at a normal landing speed under each of the following conditions:

## CS-VLA BOOK 1

(i) The aeroplane in a normal landing attitude and its landing gear retracted.

(ii) The most critical landing gear leg collapsed and the other landing gear legs extended.

### CS-VLA 969 Fuel tank expansion space

Each fuel tank must have an expansion space of not less than two percent of the tank capacity, unless the tank vent discharges clear of the aeroplane (in which case no expansion space is required). It must be impossible to fill the expansion space inadvertently with the aeroplane in the normal ground attitude.

### CS-VLA 971 Fuel tank sump

(a) Each fuel tank must have a sump with an effective capacity, in the normal ground and flight attitudes, of 0.10% of the tank capacity, or 120 cm<sup>3</sup>, whichever is the greater, unless –

(1) The fuel system has a sediment bowl or chamber that is accessible for drainage and has a capacity of 25 cm<sup>3</sup>.

(2) Each fuel tank outlet is located so that in the normal ground attitude, water will drain from all parts of the tank to the sediment bowl or chamber.

(b) Each sump, sediment bowl, and sediment chamber drain required by subparagraph (a) of this paragraph must comply with the drain provisions of CS-VLA 999 (b)(1), (2) and (3).

### CS-VLA 973 Fuel tank filler connection

(a) Fuel tank filler connections must be located outside the personnel compartment. Spilled fuel must be prevented from entering the fuel tank compartment or any part of the aeroplane other than the tank itself.

(b) Each filler cap must provide a fuel-tight seal for the main filler opening. However, there may be small openings in the fuel tank cap for venting purposes or for the purpose of allowing passage of a fuel gauge through the cap.

### CS-VLA 975 Fuel tank vents and carburettor vapour vents

(a) Each fuel tank must be vented from the top part of the expansion space. In addition –

(1) Each vent outlet must be located and constructed in a manner that minimizes the possibility of its being obstructed by ice or other foreign matter;

(2) Each vent must be constructed to prevent siphoning of fuel during normal operation;

(3) The venting capacity must allow the rapid relief of excessive differences of pressure between the interior and exterior of the tank;

(4) Airspaces of tanks with interconnected outlets must be interconnected;

(5) There may be no undrainable points in any vent line where moisture can accumulate with the aeroplane in either the ground or level flight attitudes;

(6) No vent may terminate at a point where the discharge of fuel from the vent outlet will constitute a fire hazard or from which fumes may enter personnel compartments; and

(7) Vents must be arranged to prevent the loss of fuel, except fuel discharged because of thermal expansion, when the aeroplane is parked in any direction on a ramp having a 1% slope.

(b) Each carburettor with vapour elimination connections and each fuel injection engine employing vapour return provisions must have a separate vent line to lead vapours back to the top of one of the fuel tanks. If there is more than one tank and it is necessary to use these tanks in a definite sequence for any reason, the vapour vent line must lead back to the fuel tank to be used first, unless the relative capacities of the tanks are such that return to another tank is preferable.

### CS-VLA 977 Fuel strainer or filter

(a) There must be a fuel filter between the tank outlet and the carburettor inlet (or an engine-driven fuel pump, if any). This fuel filter must –

(1) Have the capacity (with respect to operating limitations established for the engine) to ensure that engine fuel system functioning is not impaired, with the fuel contaminated to a degree (with respect to particle size and density) that is greater than that established for the engine approval; and

(2) Be easily accessible for draining and cleaning.

## CS-VLA BOOK 1

(b) There must be a strainer at the outlet of each fuel tank. This strainer must –

- (1) Have 3 to 6 meshes per cm;
- (2) Have a length of at least twice the diameter of the fuel tank outlet;
- (3) Have a diameter of at least that of the fuel tank outlet; and
- (4) Be accessible for inspection and cleaning.

### FUEL SYSTEM COMPONENTS

#### CS-VLA 991 Fuel pumps

(a) *Main pump.* For the main pump, the following applies:

For an engine installation having fuel pumps to supply fuel to the engine, at least one pump must be directly driven by the engine and must meet CS-VLA 955. This pump is a main pump.

(b) *Emergency pump.* There must be an emergency pump immediately available to supply fuel to the engine if the main pump (other than a fuel injection pump approved as part of an engine) fails. The power supply for the emergency pump must be independent of the power supply for the main pump.

(c) *Warning means.* If both the main pump and emergency pump operate continuously, there must be a means to indicate to the pilot a malfunction of either pump.

(d) Operation of any fuel pump may not affect engine operation so as to create a hazard, regardless of the engine power or the functional status of any other fuel pump.

#### CS-VLA 993 Fuel system lines and fittings

(1) Each fuel line must be installed and supported to prevent excessive vibration and to withstand loads due to fuel pressure and accelerated flight conditions.

(2) Each fuel line connected to components of the aeroplane between which relative motion could exist must have provisions for flexibility.

(3) Each flexible connection in fuel lines that may be under pressure and subjected to axial loading must use flexible hose assemblies.

(4) Each flexible hose must be approved or must be shown to be suitable for the particular application.

#### CS-VLA 995 Fuel valves and controls

(a) There must be a means to allow the pilot to rapidly shut off, in flight, the fuel to the engine.

(b) No shut-off valve may be on the engine side of any firewall. In addition, there must be means to –

(1) Guard against inadvertent operation of each shut-off valve; and

(2) Allow the pilot to reopen each valve rapidly after it has been closed.

(c) Each valve and fuel system control must be supported so that loads resulting from its operation or from accelerated flight conditions are not transmitted to the lines connected to the valve.

(d) Each valve and fuel system control must be installed so that gravity and vibration will not affect the selected position.

(e) Each fuel valve handle and its connections to the valve mechanism must have design features that minimise the possibility of incorrect installation.

(f) Each check valve must be constructed, or otherwise incorporate provisions, to preclude incorrect assembly or connection of the valve.

(g) Fuel tank selector valves must –

(1) Require a separate and distinct action to place the selector in the 'OFF' position; and

(2) Have the tank selector positions located in such a manner that it is impossible for the selector to pass through the 'OFF' position when changing from one tank to another.

#### CS-VLA 999 Fuel system drains

(a) There must be at least one drain to allow safe drainage of the entire fuel system with the aeroplane in its normal ground attitude.

(b) Each drain required by sub-paragraph (a) of this paragraph and CS-VLA 971 must –

(1) Discharge clear of all parts of the aeroplane;

## CS-VLA BOOK 1

(2) Have manual or automatic means for positive locking in the closed position; and

(3) Have a drain valve –

(i) That is readily accessible and which can be easily opened and closed; and

(ii) That is either located or protected to prevent fuel spillage in the event of a landing with landing gear retracted.

### OIL SYSTEM

#### CS-VLA 1011 General

(a) If an engine is provided with an oil system it must be capable of supplying the engine with an appropriate quantity of oil at a temperature not exceeding the maximum established as safe for continuous operation.

(b) Each oil system must have a usable capacity adequate for the endurance of the aeroplane.

(c) If an engine depends upon a fuel/oil mixture for lubrication, then a reliable means of providing it with the appropriate mixture must be established. (See AMC VLA 1011 (c).)

#### CS-VLA 1013 Oil tanks

(a) Each oil tank must be installed to –

(1) Meet the requirements of CS-VLA 967 (a), (b) and (d); and

(2) Withstand any vibration, inertia and fluid loads expected in operation.

(b) The oil level must be easy to check without having to remove any cowling parts (with the exception of oil tank access covers) or having to use any tools.

(c) If the oil tank is installed in the engine compartment it must be made of fireproof material except that, if the total oil capacity of the system including tanks, lines and sumps is less than 5 litres, it may be made of fire resistant material.

#### CS-VLA 1015 Oil tank tests

Oil tanks must be subjected to the tests specified in CS-VLA 965 for fuel tanks, except that in the pressure tests a pressure of 35 kPa must be applied.

#### CS-VLA 1017 Oil lines and fittings

(a) Oil lines must comply with CS-VLA 993.

(b) *Breather lines.* Breather lines must be arranged so that –

(1) Condensed water vapour or oil that might freeze and obstruct the line cannot accumulate at any point;

(2) The breather discharge will not constitute a fire hazard if foaming occurs or cause emitted oil to strike the pilot's wind shields;

(3) The breather does not discharge into the engine air induction system;

(4) The breather outlet is protected against blockage by ice or foreign matter.

#### CS-VLA 1019 Oil strainer or filter

Each oil strainer or filter in the Powerplant installation must be constructed and installed so that oil will flow at the normal rate through the rest of the system with the strainer or filter element completely blocked.

#### CS-VLA 1021 Oil system drains

A drain (or drains) must be provided to allow safe drainage of the oil system. Each drain must have means for positive locking in the closed position.

#### CS-VLA 1023 Oil radiators

Each oil radiator and its supporting structures must be able to withstand the vibration, inertia, and oil pressure loads to which it would be subjected in operation.

### COOLING

#### CS-VLA 1041 General

The powerplant cooling provisions must be able to maintain the temperatures of Powerplant components and engine fluids within the temperature limit established by the engine constructor during all likely operating conditions.

## CS-VLA BOOK 1

### CS-VLA 1047 Cooling test procedure for reciprocating engine aeroplanes

(a) To determine compliance with the requirement of CS-VLA 1041, a cooling test must be carried out as follows:

(1) Engine temperatures must be stabilised in flight with the engine at not less than 75% of maximum continuous power.

(2) After temperatures have stabilised, a climb must be begun at the lowest practical altitude and continued for one minute with the engine at take-off power.

(3) At the end of one minute, the climb must be continued at maximum continuous power for at least 5 minutes after the occurrence of the highest temperature recorded.

(4) For supercharged engines, the supercharger must be operated through that part of climb profile for which operation with the supercharger is requested and in a manner consistent with its intended operation.

(b) The climb required in sub-paragraph (a) of this paragraph must be conducted at a speed not more than the best rate-of-climb speed with maximum continuous power.

(c) The maximum anticipated air temperature (hot-day conditions) is 38°C at sea-level. Above sea-level, the temperature decreases with a temperature gradient of 2°C per 1 000 ft, altitude. If the tests are conducted under conditions deviating from this value, the recorded temperatures must be corrected according to sub-paragraph (d) of this paragraph, unless a more rational method is applied.

(d) The temperatures of the engine fluids and of the powerplant components (with the exception of cylinder barrels) must be corrected by adding to them the difference between the maximum ambient anticipated air temperature and the temperature of the ambient air at the time of the first occurrence of the maximum component or fluid temperature recorded during the cooling tests.

(e) Cylinder barrel temperatures must be corrected by adding to them 0.7 times the difference between the maximum ambient atmospheric temperature and the temperature of the ambient air at the time of the first occurrence of the maximum cylinder barrel temperature recorded during the cooling test.

### LIQUID COOLING

#### CS-VLA 1061 Installation

(a) *General.* Each liquid-cooled engine must have an independent cooling system (including coolant tank) installed so that –

(1) Each coolant tank is supported so that tank loads are distributed over a large part of the tank surface;

(2) There are pads between the tank and its supports to prevent chafing; and

(3) No air or vapour can be trapped in any part of the system, except the expansion tank, during filling or during operation.

Padding must be nonabsorbent or must be treated to prevent the absorption of flammable fluids.

(b) *Coolant tank*

(1) Each coolant tank must be able to withstand the vibration, inertia, and fluid loads to which it may be subjected in operation;

(2) Each coolant tank must have an expansion space of at least 10% of the total cooling system capacity; and

(3) It must be impossible to fill the expansion space inadvertently with the aeroplane in the normal ground attitude.

(c) *Filler connection.* Each coolant tank filler connection must be marked as specified in CS-VLA 1557 (c). In addition –

(1) Spilled coolant must be prevented from entering the coolant tank compartment or any part of the aeroplane other than the tank itself; and

(2) Each recessed coolant filler connection must have a drain that discharges clear of the aeroplane.

(d) *Lines and fittings.* Each coolant system line and fitting must meet the requirements of CS-VLA 993, except that the inside diameter of the engine coolant inlet and outlet lines may not be less than the diameter of the corresponding engine inlet and outlet connections.

(e) *Radiators.* Each coolant radiator must be able to withstand any vibration, inertia, and coolant pressure load to which it may normally be subjected. In addition –

(1) Each radiator must be supported to allow expansion due to operating



## CS-VLA BOOK 1

temperatures and prevent the transmittal of harmful vibration to the radiator; and

(2) If flammable coolant is used, the air intake duct to the coolant radiator must be located so that (in case of fire) flames from the nacelle cannot strike the radiator.

(f) *Drains*. There must be an accessible drain that –

(1) Drains the entire cooling system (including the coolant tank, radiator, and the engine) when the aeroplane is in the normal ground attitude;

(2) Discharges clear of the entire aeroplane; and

(3) Has means to positively lock it closed.

### CS-VLA 1063 Coolant tank tests

Each coolant tank must be tested under CS-VLA 965, except that the test required by CS-VLA 965 (a)(1) must be replaced with a similar test using the sum of the pressure developed during the maximum ultimate acceleration with a full tank or a pressure of 24 kPa, whichever is greater, plus the maximum working pressure of the system.

## INDUCTION SYSTEM

### CS-VLA 1091 Air induction

(a) The air induction system must supply the air required by the engine under the operating conditions for which certification is requested.

(b) Primary air intakes may open within the cowling if that part of the cowling is isolated from the engine accessory section by a fire-resistant diaphragm or if there are means to prevent the emergence of backfire flames.

### CS-VLA 1093 Induction system icing protection

(a) The reciprocating engine air induction system must have means to prevent and eliminate icing. Unless this is done by other means, it must be shown that, in air free of visible moisture at a temperature of  $-1^{\circ}\text{C}$  –

(1) Each aeroplane with a sea-level engine using a conventional venturi carburetor has a preheater that can provide a heat rise of

$50^{\circ}\text{C}$  with the engine at 75% of maximum continuous power;

(2) Each aeroplane with an altitude engine using a conventional venturi carburetor has a preheater that can provide a heat rise of  $67^{\circ}\text{C}$  with the engine at 75% of maximum continuous power;

(3) Each aeroplane with an altitude engine using a carburetor tending to prevent icing has a preheater that, with the engine at 60% of maximum continuous power, can provide a heat rise of  $56^{\circ}\text{C}$ ;

(4) Each aeroplane with a sea-level engine using a carburetor tending to prevent icing has a sheltered alternate source of air with a preheat of not less than that provided by the engine cooling air downstream of the cylinders.

(b) For aeroplanes with a reciprocating engine having a supercharger to pressurise the air before it enters the carburetor, the heat rise in the air caused by that supercharging at any altitude may be utilised in determining compliance with sub-paragraph (a) of this paragraph if the heat rise utilised is that which will be available, automatically, for the applicable altitudes and operating condition because of supercharging.

### CS-VLA 1101 Carburetor air preheater design

Each carburetor air preheater must be designed and constructed to –

(a) Ensure ventilation of the preheater when the engine is operated in cold air;

(b) Allow inspection of the exhaust manifold parts that it surrounds; and

(c) Allow inspection of critical parts of the preheater itself.

### CS-VLA 1103 Induction system ducts

(a) Each induction system duct must have a drain to prevent the accumulation of fuel or moisture in the normal ground and flight attitudes. No drain may discharge where it will cause a fire hazard.

(b) Each duct connected to components between which relative motion could exist, must have means for flexibility.

## CS-VLA BOOK 1

### CS-VLA 1105 Induction system screens

If induction system screens are used –

(a) Each screen must be upstream of the carburettor;

(b) If the screen is located in any part of the air induction system that is the only passage through which air can reach the engine, means must be furnished to avoid and eliminate formation of ice. (See AMC VLA 1105 (b).); and

(c) It must be impossible for fuel to strike any screen.

## EXHAUST SYSTEM

### CS-VLA 1121 General

(a) Each exhaust system must ensure safe disposal of exhaust gases without fire hazard or carbon monoxide contamination in the personnel compartment.

(b) Each exhaust system part with a surface hot enough to ignite flammable fluids or vapours must be located or shielded so that leakage from any system carrying flammable fluids or vapours will not result in a fire caused by impingement of the fluids or vapours on any part of the exhaust system including shields for the exhaust system.

(c) Each exhaust system component must be separated by fireproof shields from adjacent flammable parts of the aeroplane that are outside the engine compartment.

(d) No exhaust gases may discharge dangerously near any fuel or oil system drain.

(e) Each exhaust system component must be ventilated to prevent points of excessively high temperature.

(f) Each exhaust heat exchanger must incorporate means to prevent blockage of the exhaust port after any internal heat exchanger failure.

### CS-VLA 1123 Exhaust manifold

(a) Each exhaust manifold must be fireproof and corrosion-resistant, and must have means to prevent failure due to expansion by operating temperatures.

(b) Each exhaust manifold must be supported to withstand the vibration and inertia loads to which it may be subjected in operation.

(c) Parts of the manifold connected to components between which relative motion could exist must have means for flexibility.

### CS-VLA 1125 Exhaust heat exchangers

For reciprocating engine powered aeroplanes the following apply:

(a) Each exhaust heat exchanger must be constructed and installed to withstand the vibration, inertia, and other loads that it may be subjected to in normal operation. In addition –

(1) Each exchanger must be suitable for continued operation at high temperatures and resistant to corrosion from exhaust gases;

(2) There must be means for inspection of critical parts of each exchanger; and

(3) Each exchanger must have cooling provisions wherever it is subject to contact with exhaust gases.

(b) Each heat exchanger used for heating ventilating air must be constructed so that exhaust gases may not enter the ventilating air.

## POWERPLANT CONTROLS AND ACCESSORIES

### CS-VLA 1141 General

(a) Each control must be able to maintain any necessary position without –

(1) Constant attention by the pilot; or

(2) Tendency to creep due to control loads or vibration.

(b) Each control must be able to withstand operating loads without failure or excessive deflection.

(c) The portion of each powerplant control located in the engine compartment that is required to be operated in the event of fire must be at least fire resistant.

(d) Powerplant valve controls located in the cockpit must have –

(1) For manual valves, positive stops or in the case of fuel valves suitable index provisions, in the open and closed position; and

(2) For power-assisted valves, a means to indicate to the pilot when the valve –

## CS-VLA BOOK 1

- (i) Is in the fully open or fully closed position; or
- (ii) Is moving between the fully open and fully closed position.

### CS-VLA 1143 Engine controls

(a) The power or supercharger control must give a positive and immediate responsive means of controlling its engine or supercharger.

(b) If a power control incorporates a fuel shut-off feature, the control must have a means to prevent the inadvertent movement of the control into the shut-off position. The means must -

- (1) Have a positive lock or stop at the idle position; and
- (2) Require a separate and distinct operation to place the control in the shut-off position.

### CS-VLA 1145 Ignition switches

(a) Each ignition circuit must be independently switched, and must not require the operation of any other switch for it to be made operative.

(b) Ignition switches must be arranged and designed to prevent inadvertent operation.

(c) The ignition switch must not be used as the master switch for other circuits.

### CS-VLA 1147 Mixture control

The control must require a separate and distinct operation to move the control toward lean or shut-off position.

### CS-VLA 1163 Powerplant accessories

- (a) Each engine-driven accessory must –
  - (1) Be satisfactory for mounting on the engine concerned;
  - (2) Use the provisions on the engine for mounting; and
  - (3) Be sealed to prevent contamination of the engine oil system and the accessory system.

(b) Electrical equipment subject to arcing or sparking must be installed to minimise the probability of contact with any flammable fluids or vapours that might be present in a free state.

### CS-VLA 1165 Engine ignition systems

(a) Each battery ignition system must be supplemented by a generator that is automatically available as an alternate source of electrical energy to allow continued engine operation if any battery becomes depleted.

(b) The capacity of batteries and generators must be large enough to meet the simultaneous demands of the engine ignition system and the greatest demands of any electrical system components that draw from the same source.

(c) The design of the engine ignition system must account for -

- (1) The condition of an inoperative generator;
- (2) The condition of a completely depleted battery with the generator running at its normal operating speed; and
- (3) The condition of a completely depleted battery with the generator operating at idling speed if there is only one battery.

(d) There must be means to warn the pilot if malfunctioning of any part of the electrical system is causing the continuous discharge of any battery used for engine ignition.

## POWERPLANT FIRE PROTECTION

### CS-VLA 1182 Nacelle areas behind firewalls

Components, lines, and fittings, located behind the engine-compartment firewall must be constructed of such materials and located at such distances from the firewall that they will not suffer damage sufficient to endanger the aeroplane if a portion of the engine side of the firewall is subjected to a flame temperature of not less than 1100°C for 15 minutes. This may be shown by test or analysis.

### CS-VLA 1183 Lines, fittings and components

(a) Except as provided in sub-paragraph (b) of this paragraph, each component, line, and fitting carrying flammable fluids, gas, or air in any area subject to engine fire conditions must be at least fire resistant, except that flammable fluid tanks and supports which are part of and attached to the engine must be fireproof or be enclosed by a fireproof shield unless damage by fire to any non-fireproof part will not cause leakage or spillage of flammable fluid. Components must be shielded or located so as to

## CS-VLA BOOK 1

safeguard against the ignition of leaking flammable fluid. Flexible hose assemblies (hose and end fittings) must be approved. However, if the total capacity of the oil system, including tanks, lines and sumps is less than 5 litres, the components of this system need only be fire resistant.

(b) Sub-paragraph (a) of this paragraph does not apply to -

(1) Lines, fittings, and components which are already approved as part of a type certificated engine; and

(2) Vent and drain lines, and their fittings whose failure will not result in, or add to, a fire hazard.

### CS-VLA 1191 Firewalls

(a) The engine must be isolated from the rest of the aeroplane by a firewall, shroud or equivalent means.

(b) The firewall or shroud must be constructed so that no hazardous quantity of liquid, gas or flame can pass from the engine compartment to other parts of the aeroplane.

(c) Each opening in the firewall or shroud must be sealed with close fitting, fireproof grommets, bushings, or firewall fittings.

(d) The firewall and shroud must be fireproof and protected against corrosion.

(e) The following materials are accepted as fireproof, when used in firewalls or shrouds, without being tested:

(1) Stainless steel sheet, 0.38 mm thick;

(2) Mild steel sheet (coated with aluminium or otherwise protected against corrosion) 0.5 mm thick; and

(3) Steel or copper base alloy firewall fittings.

(f) Compliance with the criteria for fireproof materials or components must be shown as follows:

(1) The flame to which the materials or components are subjected must be  $1100 \pm 25^\circ\text{C}$ .

(2) Sheet materials approximately  $64 \text{ cm}^2$  must be subjected to the flame from a suitable burner.

(3) The flame must be large enough to maintain the required test temperature over an area approximately 13 mm square.

(4) Firewall materials and fittings must resist penetration for at least 15 minutes.

### CS-VLA 1193 Cowling and nacelle

(a) Each cowling must be constructed and supported so that it can resist any vibration, inertia, and air loads to which it may be subjected in operation.

(b) There must be means for rapid and complete drainage of each part of the cowling in the normal ground and flight attitudes. No drain may discharge where it will cause a fire hazard.

(c) Cowling must be at least fire resistant.

(d) Each part behind an opening in the engine compartment cowling must be at least fire resistant for a distance of at least 60 cm aft of the opening.

(e) Each part of the cowling subjected to high temperatures due to its nearness to exhaust system ports or exhaust gas impingement, must be fireproof.

# CS-VLA BOOK 1

## SUBPART F – EQUIPMENT

### GENERAL

#### CS-VLA 1301 Function and installation

Each item of installed equipment must –

- (a) Be of a kind and design appropriate to its intended function;
- (b) Be labelled as to its identification, function, or operating limitations, or any applicable combination of these factors;
- (c) Be installed according to limitations specified for that equipment; and
- (d) Function properly when installed.

#### CS-VLA 1303 Flight and navigation instruments

The following are required flight and navigational instruments:

- (a) An airspeed indicator;
- (b) An altimeter;
- (c) A magnetic direction indicator.

#### CS-VLA 1305 Powerplant instruments

The following are required powerplant instruments:

- (a) A fuel quantity indicator for each fuel tank. (See AMC VLA 1305 (a));
- (b) An oil pressure indicator or a low oil pressure warning for the engine except for engines with no oil pressure systems and for the super charger oil system if it is separate from other oil systems;
- (c) An oil temperature indicator except for two-stroke engines;
- (d) A tachometer;
- (e) A cylinder head temperature indicator for each air cooled engine with cowl flaps;
- (f) A fuel pressure indicator or a low fuel pressure warning for pump-fed engines;
- (g) A manifold pressure indicator for an engine with variable pitch propeller, or supercharger;
- (h) An oil quantity indicator for each tank, e.g. dipstick;
- (i) For supercharger installations, if limitations are established for either carburettor air inlet temperature or exhaust gas temperature, indicators must be furnished for each

temperature for which the limitation is established unless it is shown that the limitation will not be exceeded in all intended operations; and

- (j) A coolant temperature indicator for liquid-cooled engines.

#### CS-VLA 1307 Miscellaneous equipment

There must be an approved seat for each occupant.

#### CS-VLA 1309 Equipment, systems, and installations

The equipment, systems, and installations must be designed to minimise hazards to the aeroplane in the event of a probable malfunction or failure.

### INSTRUMENTS : INSTALLATION

#### CS-VLA 1321 Arrangement and visibility

Each flight, navigation, and powerplant instrument must be clearly arranged and plainly visible to each pilot.

#### CS-VLA 1322 Warning, caution, and advisory lights

If warning, caution, or advisory lights are installed in the cockpit, they must be –

- (a) Red, for warning lights (lights indicating a hazard which may require immediate corrective action);
- (b) Amber, for caution lights (lights indicating the possible need for future corrective action);
- (c) Green, for safe operation lights; and
- (d) Any other colour, including white, for lights not described in sub-paragraphs (a) to (c) of this paragraph, provided the colour differs sufficiently from the colours prescribed in subparagraphs (a) to (c) of this paragraph to avoid possible confusion.

#### CS-VLA 1323 Airspeed indicating system

- (a) The airspeed indicating system must be calibrated to indicate true airspeed at sea-level in standard atmosphere with a maximum pitot-static

## CS-VLA BOOK 1

error not exceeding  $\pm 8$  km/h or  $\pm 5\%$  whichever is greater, through the following speed range:

(1)  $1.3 V_{S1}$  to  $V_{NE}$ , with wing-flaps retracted.

(2)  $1.3 V_{S1}$  to  $V_{FE}$ , with wing-flaps extended.

(b) Calibration must be made in flight.

(c) The airspeed indicating system must be suitable for speeds between  $V_{S0}$  and at least 1.05 times  $V_{NE}$ .

### CS-VLA 1325 Static pressure system

(a) Each instrument provided with static pressure case connections must be so vented that the influence of aeroplane speed, the opening and closing of windows, moisture or other foreign matter, will not significantly affect the accuracy of the instruments.

(b) The design and installation of a static pressure system must be such that -

(1) Positive drainage of moisture is provided;

(2) Chafing of the tubing, and excessive distortion or restriction at bends in the tubing, is avoided; and

(3) The materials used are durable, suitable for the purpose intended, and protected against corrosion.

### CS-VLA 1327 Magnetic direction indicator

(a) The magnetic direction indicator required must be installed so that its accuracy is not excessively affected by the aeroplane's vibration or magnetic fields.

(b) The compensated installation must not have a deviation in level flight, greater than  $10^\circ$  on any heading except that when radio is transmitting the deviation may exceed  $10^\circ$  but must not exceed  $15^\circ$ .

### CS-VLA 1331 Instruments using a power supply

For each aeroplane -

(a) Each gyroscopic instrument must derive its energy from power sources adequate to maintain its required accuracy at any speed above the best rate-of-climb speed;

(b) Each gyroscopic instrument must be installed so as to prevent malfunction due to rain, oil and other detrimental elements; and

(c) There must be a means to indicate the adequacy of the power being supplied to the instruments.

### CS-VLA 1337 Powerplant instruments

(a) *Instruments and instrument lines*

(1) Each powerplant instrument line must meet the requirements of CS-VLA 993.

(2) Each line carrying flammable fluids under pressure must -

(i) Have restricting orifices or other safety devices at the source of pressure to prevent the escape of excessive fluid if the line fails; and

(ii) Be installed and located so that the escape of fluids would not create a hazard.

(3) Each powerplant instrument that utilises flammable fluids must be installed and located so that the escape of fluid would not create a hazard.

(b) *Fuel quantity indicator.* There must be a means to indicate to the pilot the quantity of fuel in each tank during flight. In addition -

(1) Each fuel quantity indicator must be calibrated to read 'zero' during level flight when the quantity of fuel remaining in the tank is equal to the unusable fuel supply determined under CS-VLA 959;

(2) Each exposed sight gauge used as a fuel quantity indicator must be protected against damage;

(3) Each sight gauge that forms a trap in which water can collect and freeze must have means to allow drainage on the ground;

(4) Tanks with interconnected outlets and airspaces may be considered as one tank and need not have separate indicators.

(c) *Fuel flowmeter system.* If a fuel flowmeter system is installed, each metering component must have a means to by-pass the fuel supply if malfunctioning of that component severely restricts fuel flow.

## ELECTRICAL SYSTEMS AND EQUIPMENT

### CS-VLA 1351 General

(a) *Electrical system capacity.* Each electrical system must be adequate for the intended use. In addition –

(1) Electric power sources, their transmission cables, and their associated control and protective devices, must be able to furnish the required power at the proper voltage to each load circuit essential for safe operation; and

(2) Compliance with sub-paragraph (a)(1) of this paragraph must be shown by an electrical load analysis, or by electrical measurements, that account for the electrical loads applied to the electrical system in probable combinations and for probable durations.

(b) *Functions.* For each electrical system, the following apply:

(1) Each system, when installed, must be –

(i) Free from hazards in itself, in its method of operation, and in its effects on other parts of the aeroplane;

(ii) Protected from fuel, oil, water, other detrimental substances, and mechanical damage; and

(iii) So designed that the risk of electrical shock to occupants and ground personnel is reduced to a minimum.

(2) Electric power sources must function properly when connected in combination or independently, except that alternators may depend on a battery for initial excitation or for stabilisation.

(3) No failure or malfunction of any electric power source may impair the ability of any remaining source to supply load circuits essential for safe operation, except that the operation of an alternator that depends on a battery for initial excitation or for stabilisation may be stopped by failure of that battery.

(4) Each electric power source control must allow the independent operation of each source, except that controls associated with alternators that depend on a battery for initial excitation or for stabilisation need not break

the connection between the alternator and its battery.

(c) *Generating system.* There must be at least one generator if the electrical system supplies power to load circuits essential for safe operation. In addition –

(1) Each generator must be able to deliver its continuous rated power;

(2) Generator voltage control equipment must be able to dependably regulate the generator output within rated limits;

(3) Each generator must have a reverse current cut out designed to disconnect the generator from the battery and from the other generators when enough reverse current exists to damage that generator;

(4) There must be a means to give immediate warning to the pilot of a failure of any generator; and

(5) Each generator must have an overvoltage control designed and installed to prevent damage to the electrical system, or to equipment supplied by the electrical system, that could result if that generator were to develop an overvoltage condition.

(d) *Instruments.* There must be a means to indicate to the pilot that the electrical power supplies are adequate for safe operation. For direct current systems, an ammeter in the battery feeder may be used.

(e) *Fire resistance.* Electrical equipment must be so designed and installed that in the event of a fire in the engine compartment, during which the surface of the firewall adjacent to the fire is heated to 1100°C for 5 minutes or to a lesser temperature substantiated by the applicant, the equipment essential to continued safe operation and located behind the firewall will function satisfactorily and will not create an additional fire hazard. This may be shown by test or analysis.

(f) *External power.* If provisions are made for connecting external power to the aeroplane, and that external power can be electrically connected to equipment other than that used for engine starting, means must be provided to ensure that no external power supply having a reverse polarity, or a reverse phase sequence, can supply power to the aeroplane's electrical system.

## CS-VLA BOOK 1

### CS-VLA 1353 Storage battery design and installation

(a) Each storage battery must be designed and installed as prescribed in this paragraph.

(b) Safe cell temperatures and pressures must be maintained during any probable charging and discharging condition. No uncontrolled increase in cell temperature may result when the battery is recharged (after previous complete discharge) –

(1) At maximum regulated voltage or power;

(2) During a flight of maximum duration; and

(3) Under the most adverse cooling condition likely to occur in service.

(c) Compliance with sub-paragraph (b) of this paragraph must be shown by tests unless experience with similar batteries and installations has shown that maintaining safe cell temperatures and pressures presents no problem.

(d) No explosive or toxic gases emitted by any battery in normal operation, or as the result of any probable malfunction in the charging system or battery installation, may accumulate in hazardous quantities within the aeroplane.

(e) No corrosive fluids or gases that may escape from the battery may damage surrounding structures or adjacent essential equipment.

(f) Each nickel cadmium battery installation capable of being used to start an engine or auxiliary power unit must have provisions to prevent any hazardous effect on structure or essential systems that may be caused by the maximum amount of heat the battery can generate during a short circuit of the battery or of its individual cells.

(g) Nickel cadmium battery installations capable of being used to start an engine or auxiliary power unit must have –

(1) A system to control the charging rate of the battery automatically so as to prevent battery overheating;

(2) A battery temperature sensing and over-temperature warning system with a means for disconnecting the battery from its charging source in the event of an over-temperature condition; or

(3) A battery failure sensing and warning system with a means for disconnecting the battery from its charging source in the event of battery failure.

### CS-VLA 1357 Circuit protective devices

(a) Protective devices, such as fuses or circuit breakers, must be installed in all electrical circuits other than –

(1) The main circuit of starter motors; and

(2) Circuits in which no hazard is presented by their omission.

(b) A protective device for a circuit essential to flight safety may not be used to protect any other circuit.

(c) Each resettable circuit protective device ('trip free' device in which the tripping mechanism cannot be overridden by the operating control) must be designed so that –

(1) A manual operation is required to restore service after tripping; and

(2) If an overload or circuit fault exists, the device will open the circuit regardless of the position of the operating control.

(d) If the ability to reset a circuit breaker or replace a fuse is essential to safety in flight, that circuit breaker or fuse must be so located and identified that it can be readily reset or replaced in flight.

(e) If fuses are used, there must be one spare of each rating, or 50% spare fuses of each rating, whichever is greater.

### CS-VLA 1361 Master switch arrangement

(a) There must be a master switch or switches arranged to allow ready disconnection of all electric power sources. The point of disconnection must be adjacent to the sources controlled by the switch.

(b) The master switch arrangement must be so installed that it is easily discernible and accessible to the pilot in flight.

### CS-VLA 1365 Electric cables and equipment

(a) Each electric connecting cable must be of adequate capacity.

(b) Each cable and associated equipment that would overheat in the event of circuit overload or fault must be at least flame resistant and may not emit dangerous quantities of toxic fumes.



## CS-VLA BOOK 1

### CS-VLA 1367 Switches

Each switch must be –

- (a) Able to carry its rated current;
- (b) Constructed with enough distance or insulating material between current carrying parts and the housing so that vibration in flight will not cause shorting;
- (c) Accessible to the pilot; and
- (d) Labelled as to operation and the circuit controlled.

(c) There must be means to prevent excessive pressure resulting from fluid volumetric changes.

(d) Tests. It must be shown by tests that –

(1) The system is fully efficient when it has to transmit the maximum pilot force to which it can be submitted.

(2) There is no permanent deformation or leakage, when the system is submitted to the maximum pilot force. (See CS-VLA 405.) (See AMC VLA 1436.)

## LIGHTS

### CS-VLA 1384 External lights

If external lights are installed they must comply with the applicable sub-paragraphs of paragraph 23.1385 to 23.1401, of CS-23.

## SAFETY EQUIPMENT

### CS-VLA 1411 General

(a) When safety equipment is installed it must be readily accessible; and

(b) Stowage provisions for that equipment must be furnished and must –

(1) Be arranged so that the equipment is directly accessible and its location is obvious; and

(2) Protect the safety equipment from damage caused by being subjected to the inertia loads specified in CS-VLA 561.

## MISCELLANEOUS EQUIPMENT

### CS-VLA 1431 Electronic equipment

Electronic equipment and installations must be free from hazards in themselves, in their method of operation, and in their effects on other components.

### CS-VLA 1436 Hydraulic manually-powered brake systems

(a) Each hydraulic manually-powered brake system and its elements must withstand without yielding, the structural loads expected, in addition to hydraulic loads.

(b) A means to verify the quantity of hydraulic fluid in the system must be provided.

**CS-VLA BOOK 1**

# CS-VLA BOOK 1

## SUBPART G – OPERATING LIMITATIONS AND INFORMATION

### CS-VLA 1501 General

(a) Each operating limitation specified in CS-VLA 1505 to 1525 and other limitations and information necessary for safe operation must be established.

(b) The operating limitations and other information necessary for safe operation must be made available to the pilot as prescribed in CS-CS 1541 to 1589.

### CS-VLA 1505 Airspeed limitations

(a) The never-exceed speed  $V_{NE}$  must be established so that it is –

(1) Not less than 0.9 times the minimum value of  $V_D$  allowed under CS-VLA 335; and

(2) Not more than the lesser of –

(i) 0.9  $V_D$  established under CS-VLA 335; or

(ii) 0.9 times the maximum speed shown under CS-VLA 251.

(b) The maximum structural cruising speed  $V_{NO}$  must be established so that it is –

(1) Not less than the minimum value of  $V_C$  allowed under CS-VLA 335; and

(2) Not more than the lesser of –

(i)  $V_C$  established under CS-VLA 335; or

(ii) 0.89  $V_{NE}$  established under sub-paragraph (a) of this paragraph.

### CS-VLA 1507 Manoeuvring speed

The manoeuvring speed  $V_A$ , determined under CS-VLA 335, must be established as an operating limitation.

### CS-VLA 1511 Flap extended speed

(a) The flap extended speed  $V_{FE}$  must be established so that it is –

(1) Not less than the minimum value of  $V_F$  allowed in CS-VLA 345 and 457; and

(2) Not more than the lesser of –

(i)  $V_F$  established under CS-VLA 345; or

(ii)  $V_F$  established under CS-VLA 457.

(b) Additional combinations of flap setting, airspeed, and engine power may be established if the structure has been proven for the corresponding design conditions.

### CS-VLA 1519 Weight and centre of gravity

The weight and centre of gravity limitations determined under CS-VLA 23 must be established as operating limitations.

### CS-VLA 1521 Powerplant limitations

(a) *General.* The powerplant limitations prescribed in this paragraph must be established so that they do not exceed the corresponding limits for which the engine or propeller is type certificated.

(b) *Take-off operation.* The Powerplant take-off operation must be limited by –

(1) The maximum rotational speed power;

(2) The maximum allowable manifold pressure for aeroplanes equipped with a variable pitch propeller or supercharger;

(3) The time limit for the use of the power or thrust corresponding to the limitations established in sub-paragraphs (b)(1) and (b)(2) of this paragraph; and

(4) If the time limit in sub-paragraph (b)(3) of this paragraph exceeds two minutes, the maximum allowable cylinder head (as applicable), liquid coolant, and oil temperatures.

(c) *Continuous operation.* The continuous operation must be limited by –

(1) The maximum rotational speed;

(2) The maximum allowable manifold pressure for aeroplanes equipped with a variable pitch propeller or supercharger;

(3) The maximum allowable cylinder head, oil, and liquid coolant temperatures.

(d) *Fuel grade.* The minimum fuel grade must be established so that it is not less than that required for the operation of the engine within the limitations in sub-paragraphs (b) and (c) of this paragraph.

### CS-VLA 1525 Kinds of operation

The kinds of operation to which the aeroplane is limited are established by the category in

## CS-VLA BOOK 1

which it is eligible for certification and by the installed equipment.

### CS-VLA 1529 Maintenance manual

A maintenance manual containing the information that the applicant considers essential for proper maintenance must be provided. At least the following must be considered in developing the essential information:

- (a) Description of systems;
- (b) Lubrication instructions setting forth the frequency and the lubricants and fluids which are to be used in the various systems;
- (c) Pressures and electrical loads applicable to the various systems;
- (d) Tolerances and adjustments necessary for proper functioning of the aeroplane;
- (e) Methods of levelling, jacking, raising, and ground towing;
- (f) Methods of balancing control surfaces, and maximum permissible values of play at hinge pins and control circuit backlash;
- (g) Identification of primary and secondary structures;
- (h) Frequency and extent of inspections necessary for proper maintenance of the aeroplane;
- (i) Special repair methods applicable to the aeroplane;
- (j) Special inspection techniques;
- (k) List of special tools;
- (l) Statement of service life limitations (replacement or overhaul) of parts, components and accessories subject to such limitations, unless those limitations are given in documents referred to in (m);
- (m) List of maintenance documents for parts, components and accessories approved independently of the aeroplane;
- (n) The materials necessary for small repairs.
- (o) Care and cleaning recommendations;
- (p) List of placards and markings and their locations;
- (q) Instructions for rigging and de-rigging;
- (r) Information on supporting points and means to prevent damage during ground transport, rigging and de-rigging; and

(s) Instructions for weighing the aircraft and determining the actual centre of gravity.

### MARKINGS AND PLACARDS

#### CS-VLA 1541 General

- (a) The aeroplane must contain –
  - (1) The markings and placards specified in CS-VLA 1545 to 1567; and
  - (2) Any additional information, instrument markings, and placards required for the safe operation if it has unusual design, operating, or handling characteristics.
- (b) Each marking and placard prescribed in sub-paragraph (a) of this paragraph –
  - (1) Must be displayed in a conspicuous place; and
  - (2) May not be easily erased, disfigured, or obscured.
- (c) The units of measurement used on placards must be the same as those used on the indicators.

#### CS-VLA 1543 Instrument markings: general

For each instrument –

- (a) When markings are on the cover glass of the instrument, there must be means to maintain the correct alignment of the glass cover with the face of the dial; and
- (b) Each arc and line must be wide enough and located to be clearly visible to the pilot.

#### CS-VLA 1545 Airspeed indicator

- (a) Each airspeed indicator must be marked as specified in subparagraph (b) of this paragraph, with the marks located at the corresponding indicated airspeed.
- (b) The following markings must be made:
  - (1) For the never-exceed speed  $V_{NE}$ , a radial red line.
  - (2) For the caution range, a yellow arc; extending from the red line specified in subparagraph (b)(1) of this paragraph to the upper limit of the green arc specified in subparagraph (b)(3) of this paragraph.
  - (3) For the normal operating range, a green arc with the lower limit at  $V_{S1}$  with maximum weight and with landing gear and wing flaps retracted, and the upper limit at the

## CS-VLA BOOK 1

maximum structural cruising speed  $V_{NO}$  established under CS-VLA 1505 (b).

(4) For the flap operating range, a white arc with the lower limit at  $V_{SO}$  at the maximum weight and the upper limit at the flaps-extended speed  $V_{FE}$  established under CS-VLA 1511.

### CS-VLA 1547 Magnetic direction indicator

(a) A placard meeting the requirements of this section must be installed on or near the magnetic direction indicator.

(b) The placard must show the calibration of the instrument in level flight with the engine operating.

(c) The placard must state whether the calibration was made with radio receivers on or off.

(d) Each calibration reading must be in terms of magnetic headings in not more than 30° increments.

### CS-VLA 1549 Powerplant instruments

For each required powerplant instrument, as appropriate to the type of instruments –

(a) Each maximum and if applicable, minimum safe operating limit must be marked with a red radial or a red line; –

(b) Each normal operating range must be marked with a green arc or green line not extending beyond the maximum and minimum safe limits;

(c) Each take-off and precautionary range must be marked with a yellow arc or a yellow line; and

(d) Each engine or propeller range that is restricted because of excessive vibration stresses must be marked with red arcs or red lines.

### CS-VLA 1551 Oil quantity indicator

Each oil quantity indicator must be marked to clearly indicate the maximum and minimum quantity of oil that is acceptable.

### CS-VLA 1555 Control markings

(a) Each cockpit control, other than primary flight controls and simple push button type starter switches, must be plainly marked as to its function and method of operation.

(b) Each secondary control must be suitably marked.

(c) For powerplant fuel controls –

(1) Each fuel tank selector control must be marked to indicate the position corresponding to each tank and to each existing cross feed position;

(2) If safe operation requires the use of any tanks in a specific sequence, that sequence must be marked on or near the selector for those tanks;

(3) The conditions under which the full amount of usable fuel in any restricted usage fuel tank can safely be used must be stated on a placard adjacent to the selector valve for that tank.

(d) For accessory, auxiliary, and emergency controls –

(1) If retractable landing gear is used the indicator required by CS-VLA 729 must be marked so that the pilot can, at any time ascertain that the wheels are secured in the extreme positions; and

(2) Each emergency control must be red and must be marked as to method of operation.

### CS-VLA 1557 Miscellaneous markings and placards

(a) *Baggage and cargo compartments, and ballast location.* Each baggage and cargo compartment, and each ballast location, must have a placard stating any limitations on contents, including weight, that are necessary under the loading requirements.

(b) *Fuel and oil filler openings.* The following apply:

(1) Fuel filler openings must be marked at or near the filler cover with the minimum fuel grade, fuel designation, fuel capacity of the tank, and for each 2-stroke engine without a separate oil system, fuel/oil mixture ratio.

(2) Oil filler openings must be marked at or near the filler cover:

(i) With the grade; and

(ii) If the oil is detergent or non-detergent.

(c) *Fuel tanks.* The usable fuel capacity in volumetric units of each tank must be marked at the selector and on the fuel quantity indicator.

## CS-VLA BOOK 1

(d) When an emergency exit is provided in compliance with CS-VLA 807, each operating control must be red. The placards must be near each control and must clearly indicate its method of operation.

(e) The system voltage of each direct current installation must be clearly marked adjacent to its external power connection.

### CS-VLA 1559 Operating limitations placards

The following placards must be plainly visible to the pilot:

(a) A placard stating the following airspeeds (IAS):

(1) Design manoeuvring speed,  $V_A$ ;

(2) The maximum landing gear operating speed,  $V_{LO}$ .

(b) A placard stating 'This aeroplane is classified as a very light aeroplane approved for day VFR only, in non-icing conditions. All aerobatic manoeuvres including intentional spinning are prohibited. See Flight Manual for other limitations'.

### CS-VLA 1561 Safety equipment

(a) When installed, safety equipment must be plainly marked as to method of operation; and

(b) Stowage provisions for that equipment must be marked for the benefit of occupants.

## AEROPLANE FLIGHT MANUAL AND APPROVED MANUAL MATERIAL

### CS-VLA 1581 General

(See AMC VLA 1581)

(a) *Furnishing information.* A Flight Manual must be furnished with each aeroplane. There must be an appropriate location for stowage of the Flight Manual aboard the aeroplane and each Flight Manual must contain the following:

(1) Information required in CS-VLA 1583 to 1589 including the explanation necessary for their proper use and the significance of the symbols used.

(2) Other information that is necessary for safe operation because of design operating or handling characteristics, including the effect of rain and insects accumulation on flight characteristics and performances as determined under CS-VLA 21 (d).

(3) A list of effective pages, with identification of those containing approved information according to sub-paragraph (b) of this paragraph.

(b) *Approved information.* Each part of the Flight Manual containing information prescribed in CS-VLA 1583 to 1587 (a) must be limited to such information and must be approved, identified and clearly distinguished from each other part of the Flight Manual. All Manual material must be of a type that is not easily erased, disfigured or misplaced, and it must be in the form of individual sheets capable of being inserted in a Manual provided by the applicant, or in a folder or in any other permanent form.

(c) *Non-approved information.* Non-approved information must be presented in a manner acceptable to the Agency.

(d) *Units.* The units of measurement used in the Flight Manual must be the same as those used on the indicators.

### CS-VLA 1583 Operating limitations

(a) *Airspeed limitations.* The following information must be furnished

(1) Information necessary for the marking of the airspeed limits on the indicator, as required in CS-VLA 1545 and the significance of the colour coding used on the indicator.

(2) The speeds  $V_A$ ,  $V_{LO}$ ,  $V_{LE}$  where appropriate.

(b) *Weights.* The following information must be furnished:

(1) The maximum weight.

(2) Any other weight limits, if necessary.

(c) *Centre of gravity.* The established c.g. limits required by CS-VLA 23 must be furnished.

(d) *Manoeuvres.* Authorised manoeuvres established in accordance with CS-VLA 3.

(e) *Flight load factors.* Manoeuvring load factors: the following must be furnished:

(1) The factors corresponding to point A and point C of figure 1 of CS-VLA 333 (b), stated to be applicable at  $V_A$ .

(2) The factors corresponding to point D and point E of figure 1 of CS-VLA 333 (b) to be applicable at  $V_{NE}$ .

## CS-VLA BOOK 1

(3) The factor with wing flaps extended as specified in CS-VLA 345.

(f) *Kinds of operation.* The kinds of operation (day VFR) in which the aeroplane may be used, must be stated. The minimum equipment required for the operation must be listed.

(g) *Powerplant limitations.* The following information must be furnished:

(1) Limitation required by CS- VLA 1521.

(2) Information necessary for marking the instruments required by CS-VLA 1549 to 1553.

(3) Fuel and oil designation.

(4) For two-stroke engines, fuel/oil ratio.

(h) *Placards.* Placards required by CS-VLA 1555 to 1561 must be presented.

### CS-VLA 1585 Operating data and procedures

Information concerning normal and emergency procedures and other pertinent information necessary for safe operation must be furnished, including –

(a) The stall speed in the various configurations.

(b) Any loss of altitude more than 30 m or any pitch attitude more than 30° below the horizon occurring during the recovery part of the manoeuvre prescribed in CS-VLA 201.

(c) Any loss of altitude of more than 30 m occurring in the recovery part of the manoeuvre prescribed in CS-VLA 203.

(d) Recommended recovery procedure to recover from an inadvertent spin.

(e) Special procedures to start the engine in flight, if necessary.

(f) Information on the total quantity of usable fuel, and conditions under which the full amount of usable fuel in each tank can safely be used.

### CS-VLA 1587 Performance information

(a) *General.* For each aeroplane, the following information must be furnished

(1) The take-off distance determined under CS-VLA 51, the airspeed at the 15 m

height, the aeroplane configuration (if pertinent), the kind of surface in the tests, and the pertinent information with respect to cowl flap position, use of flight path control devices, and use of the landing gear retraction system.

(2) The landing distance determined under CS-VLA 75, the aeroplane configuration (if pertinent), the kind of surface used in the tests, and the pertinent information with respect to flap position and the use of flight path control devices.

(3) The steady rate or gradient of climb determined under CS-VLA 65 and 77, the airspeed, power, and the aeroplane configuration.

(4) The calculated approximate effect on take-off distance (sub-paragraph (a)(1) of this paragraph), landing distance (sub-paragraph (a)(2) of this paragraph), and steady rates of climb (sub-paragraph (a)(3) of this paragraph), of variations in altitude and temperature. (See AMC VLA 1587(a)(4).)

(5) The maximum atmospheric temperature at which compliance with the cooling provisions of CS-VLA 1041 to 1047 is shown.

(b) *Skiplanes.* For skiplanes a statement of the approximate reduction in climb performance may be used instead of complete new data for skiplane configuration, if -

(1) The landing gear is fixed in both landplane and skiplane configurations;

(2) The climb requirements are not critical; and

(3) The climb reduction in the skiplane configurations is small (0.15 to 0.25 m/s (30 to 50 feet per minute)).

(c) *Information concerning normal procedures*

(1) The demonstrated crosswind velocity and procedures and information pertinent to operation of the aeroplane in crosswinds, and

(2) The airspeeds, procedures, and information pertinent to the use of the following airspeeds:

(i) The recommended climb speed and any variation with altitude.

(ii)  $V_X$  (speed for best angle of climb) and any variation with altitude.

## CS-VLA BOOK 1

(iii) The approach speeds, including speeds for transition to the balked landing condition.

(d) An indication of the effect on take-off distance of a grass surface as determined from at least one take-off measurement on short mown dry grass must be furnished.

### CS-VLA 1589 Loading information

The following loading information must be furnished:

(a) The weight and location of each item of equipment installed when the aeroplane was weighed under CS-VLA 25.

(b) Appropriate loading instructions for each possible loading condition between the maximum and minimum weights determined under CS-VLA 25 that can result in a centre of gravity beyond –

(1) The extremes selected by the applicant;

(2) The extremes within which the structure is proven; or

(3) The extremes within which compliance with each functional requirement is shown.

I



# CS-VLA BOOK 1

## APPENDICES

### Appendix A

#### Simplified Design Load Criteria For Conventional Very Light Aeroplanes

##### A1 General

(a) The design load criteria in this Appendix are an approved equivalent of those in CS-VLA 321 to 459 of this document for the certification of conventional very light aeroplanes as defined in CS-VLA 1 and 301 (d) and AMC 301 (d).

(b) Unless otherwise stated, the nomenclature and symbols in this Appendix are the same as the corresponding nomenclature and symbols in CS-VLA.

##### A3 Special symbols

$n_1$	=	Aeroplane Positive Manoeuvring Limit Load Factor
$n_2$	=	Aeroplane Negative Manoeuvring Limit Load Factor
$n_3$	=	Aeroplane Positive Gust Limit Load Factor at $V_C$
$n_4$	=	Aeroplane Negative Gust Limit Load Factor at $V_C$
$n_{flap}$	=	Aeroplane Positive Limit Load Factor With Flaps Fully Extended at $V_F$
$*V_{Fmin}$	=	Minimum Design Flap Speed = $4.98 \sqrt{n_1 W/S}$ knots.
$*V_{Amin}$	=	Minimum Design Manoeuvring Speed = $6.79 \sqrt{n_1 W/S}$ knots.
$*V_{Cmin}$	=	Minimum Design Cruising Speed = $7.69 \sqrt{n_1 W/S}$ knots.
$*V_{Dmin}$	=	Minimum Design Dive Speed = $10.86 \sqrt{n_1 W/S}$ knots.

\*Also see sub-paragraph A7(e)(2) of this Appendix.  
(Speeds in knots, W in kg, S in  $m^2$ .)

##### A7 Flight loads

(a) Each flight load may be considered independent of altitude and, except for the local supporting structure for dead weight items, only the maximum design weight conditions must be investigated.

(b) Tables 1 and 3 and figure A3 of this Appendix must be used to determine values of  $n_1$ ,  $n_2$ ,  $n_3$  and  $n_4$ , corresponding to the maximum design weights in the desired Categories.

(c) Figures A1 and A2 of this Appendix must be used to determine values of  $n_3$  and  $n_4$  corresponding to the minimum flying weights in the desired categories, and, if these load factors are greater than the load factors at the design weight, the supporting structure for dead weight items must be substantiated for the resulting higher load factors.

(d) Each specified wing and tail loading is independent of the centre of gravity range. However, a c.g. range, must be selected for the aeroplane and the basic fuselage structure must be investigated for the most adverse dead weight loading conditions for the c.g. range selected.

(e) The following loads and loading conditions are the minimums for which strength must be provided in the structure:

(1) *Aeroplane equilibrium.* The aerodynamic wing loads may be considered to act normal to the relative wind, and to have a magnitude of 1.05 times the aeroplane normal loads (as determined from sub-paragraph A9 (b) and (c) of this Appendix) for the positive flight conditions and a magnitude equal to the aeroplane normal loads for the negative conditions. Each chordwise and normal component of this wing load must be considered.

(2) *Minimum design airspeeds.* The minimum design airspeeds may be chosen by the applicant except that they may not be less than the minimum speeds found by using Table 3 of this Appendix. In addition,  $V_{Cmin}$  need not exceed values of  $0.9 V_H$  actually obtained at sea level for the lowest design weight category for which certification is desired. In computing these minimum design airspeeds,  $n_i$  may not be less than 3.8.

(3) *Flight load factor.* The limit flight load factors specified in Table 1 of this Appendix represent the ratio of the aerodynamic force component (acting normal to the assumed longitudinal axis of the aeroplane) to the weight of the aeroplane. A positive flight load factor is an aerodynamic

force acting upward, with respect to the aeroplane.

### A9 Flight conditions

(a) *General.* Each design condition in sub-paragraphs (b) and (c) of this paragraph must be used to assure sufficient strength for each condition of speed and load factor on or within the boundary of a V-n diagram for the aeroplane similar to the diagram in figure A3 of this Appendix. This diagram must also be used to determine the aeroplane structural operating limitations as specified in CS-VLA 1501 (c) to 1511 and 1519.

(b) *Symmetrical flight conditions.* The aeroplane must be designed for symmetrical flight conditions as follows:

(1) The aeroplane must be designed for at least the four basic flight conditions, 'A', 'D', 'E', and 'G' as noted on the flight envelope of figure A3 of this Appendix. In addition, the following requirements apply:

(i) The design limit flight load factors corresponding to conditions 'D' and 'E' of figure A3 must be at least as great as those specified in Table 1 and figure A3 of this Appendix, and the design speed for these conditions must be at least equal to the value of  $V_{Dmin}$  found from Table 3 of this Appendix.

(ii) For conditions 'A' and 'G' of figure A3, the load factors must correspond to those specified in Table 1 of this Appendix, and the design speeds must be computed using these load factors with the maximum static life coefficient  $C_{NA}$  determined by the applicant. However, in the absence of more precise computations, these latter conditions may be based on a value of  $C_{NA} = \pm 35$  and the design speed for condition 'A' may be less than  $V_{Amin}$ .

(iii) Conditions 'C' and 'F' of figure A3 need only be investigated when  $n_3$  W/S or  $n_4$  W/S are greater than  $n_1$  W/S or  $n_2$  W/S of this Appendix, respectively. The use of figures A1 and A2 for points 'C' and 'F' is restricted to wings of Aspect Ratio of 7 or less. In other cases, the method of CS-VLA 341 should be used.

(2) If flaps or other high lift devices intended for use at the relatively low airspeed of approach, landing, and take-off, are

installed, the aeroplane must be designed for the two flight conditions corresponding to the values of limit flap-down factors specified in Table 1 of this Appendix with the flaps fully extended at not less than the design flap speed  $V_{Fmin}$  from Table 3 of this Appendix.

(c) *Unsymmetrical flight conditions.* Each affected structure must be designed for unsymmetrical loadings as follows:

(1) The aft fuselage-to-wing attachment must be designed for the critical vertical surface load determined in accordance with sub-paragraphs A11 (c)(1) and (2) of this Appendix.

(2) The wing and wing carry-through structures must be designed for 100% of condition 'A' loading on one side of the plane of symmetry and 70% on the opposite side.

(3) The wing and wing carry-through structures must be designed for the loads resulting from a combination of 75% of the positive manoeuvring wing loading on both sides of the plane of symmetry and the maximum wing torsion resulting from aileron displacement. The effect of aileron displacement on wing torsion at  $V_C$  or  $V_A$  using the basic aerofoil moment coefficient,  $C_{mo}$ , modified over the aileron portion of the span, must be computed as follows:

(i)  $C_m = C_{mo} + 0.01 \delta_u$  (up aileron side) wing basic aerofoil.

(ii)  $C_m = C_{mo} - 0.01 \delta_d$  (down aileron side) wing basic aerofoil, where  $\delta_u$  is the up aileron deflection and  $\delta_d$  is the down aileron.

(4)  $\Delta$  critical, which is the sum of  $\delta_u + \delta_d$ , must be computed as follows:

(i) Compute  $\Delta_a$  and  $\Delta_b$  from the formulae –

$$\Delta_a = \frac{V_A}{V_C} \times \Delta_p \text{ and}$$

$$\Delta_b = 0.5 \frac{V_A}{V_D} \times \Delta_p$$

where  $\Delta_p$  = the maximum total deflection (sum of both aileron deflections) at  $V_A$  with  $V_A$ ,  $V_C$ , and  $V_D$  described in sub-paragraph (2) of A7(e) of this Appendix.

(ii) Compute  $K$  from the formula –

$$K = \frac{(C_{m0} - 0.01\delta_b) V_D^2}{(C_{m0} - 0.01\delta_a) V_C^2}$$

where  $\delta_a$  is the down aileron deflection corresponding to  $\Delta_a$  and  $\delta_b$  is the down aileron deflection corresponding to  $\Delta_b$  as computed in step (i).

(iii) If  $K$  is less than 1.0,  $\Delta_a$  is  $\Delta$  critical and must be used to determine  $\delta_u$ , and  $\delta_d$ . In this case,  $V_C$  is the critical speed which must be used in computing the wing torsion loads over the aileron span.

(iv) If  $K$  is equal to or greater than 1.0,  $\Delta_b$  is  $\Delta$  critical and must be used to determine  $\delta_u$  and  $\delta_d$ . In this case,  $V_D$  is the critical speed which must be used in computing the wing torsion loads over the aileron span.

(d) *Supplementary conditions; rear lift truss; engine torque; side load on engine mount.* Each of the following supplementary conditions must be investigated:

(1) In designing the rear lift truss, the special condition specified in CS-VLA 369 may be investigated instead of condition 'G' of figure A3 of this Appendix.

(2) The engine mount and its supporting structure must be designed for the maximum limit torque corresponding to Maximum Expected Take-off Power and propeller speed acting simultaneously with the limit loads resulting from the maximum positive manoeuvring flight load factor  $n_1$ . The limit torque must be obtained by multiplying the mean torque by the factor defined in CS-VLA 361 (b).

(3) The engine mount and its supporting structure must be designed for the loads resulting from a lateral limit load factor of not less than 1.47.

### A11 Control surface loads

(a) *General.* Each control surface load must be determined using the criteria of sub-paragraph (b) of this paragraph and must lie within the simplified loadings of sub-paragraph (c) of this paragraph.

(b) *Limit pilot forces.* In each control surface loading condition described in sub-paragraphs (c) to (e) of this paragraph, the airloads on the movable surfaces and the corresponding deflections need not exceed those

which could be obtained in flight by employing the maximum limit pilot forces specified in the table in CS-VLA 397 (b). If the surface loads are limited by these maximum limit pilot forces, the tabs must either be considered to be deflected to their maximum travel in the direction which would assist the pilot or the deflection must correspond to the maximum degree of 'out of trim' expected at the speed for the condition under consideration. The tab load, however, need not exceed the value specified in Table 2 of this Appendix.

(c) *Surface loading conditions.* Each surface loading condition must be investigated as follows:

(1) Simplified limit surface loadings and distributions for the horizontal tail, vertical tail, aileron, wing flaps, and trim tabs are specified in Table 2 and figures A4 and A5 of this Appendix. If more than one distribution is given, each distribution must be investigated. Figure A4 is limited to use with vertical tails with aspect ratios less than 2.5 and horizontal tails with aspect ratios less than 5 and tail volumes greater than 0.4.

(d) *Outboard fins.* Outboard fins must meet the requirements of CS-VLA 445.

(e) *T- and V-tails.* T- and V-tails must meet the requirements of CS-VLA 427.

(f) *Special devices.* Special devices must meet the requirements of CS-VLA 459.

### A13 Control system loads

(a) *Primary flight controls and systems.* Each primary flight control and system must be designed as follows:

(1) The flight control system and its supporting structure must be designed for loads corresponding to 125% of the computed hinge moments of the movable control surface in the conditions prescribed in paragraph A11 of this Appendix. in addition -

(i) The system limit loads need not exceed those that could be produced by the pilot and automatic devices operating the controls; and

(ii) The design must provide a rugged system for service use, including jamming, ground gusts, taxiing downwind, control inertia, and friction.

(2) Acceptable maximum and minimum limit pilot forces for elevator, aileron, and rudder controls are shown in the

## CS-VLA BOOK 1

table in CS-VLA 387 (b). These pilots loads must be assumed to act at the appropriate control grips or pads as they would under flight conditions, and to be reacted at the attachments of the control system to the control surface horn.

(b) *Dual controls*. If there are dual controls, the systems must be designed for pilots operating in opposition, using individual pilot loads equal to 75% of those obtained in accordance with subparagraph (a) of this paragraph, except that

individual pilot loads may not be less than the minimum limit pilot forces shown in the table in CS-VLA 397(b).

(c) *Ground gust conditions*. Ground gust conditions must meet the requirements of CS-VLA 415.

(d) *Secondary controls and systems*. Secondary controls and systems must meet the requirements of CS-VLA 405.

**Table 1 – Limit flight load factors**

LIMIT FLIGHT LOAD FACTORS					
			Normal Category	Utility category	Aerobatic category
FLIGHT LOAD FACTORS	Flaps Up	n1	3.8	4.4	6.0
		n2	-0.5 n1		
		n3	Find n3 from Figure A1		
		n4	Find n4 from Figure A2		
	Flaps Down	nflap	0.5 n1		
		nflap	Zero*		

\*Vertical wing load may be assumed equal to zero and only the flap part of the wing need be checked for this condition.

# CS-VLA BOOK 1

## Table 2 - Average limit control surface loading

AVERAGE LIMIT CONTROL SURFACE LOADING				
SURFACE		DIRECTION OF LOADING	MAGNITUDE OF LOADING	CHORDWISE DISTRIBUTION
HORIZONTAL TAIL I	(a)	Up and Down	Figure A4 Curve (2)	
	(b)	Unsymmetrical loading (Up and Down)	100% $\bar{w}$ on one side airplane $\bar{C}$ 65% $\bar{w}$ on other side airplane $\bar{C}$ for normal and utility categories.  For aerobatic category see A11(c)	
VERTICAL TAIL II	(a)	Right and Left	Figure A4 Curve (1)	Same as (A) above
	(b)	Right and Left	Figure A4 Curve (1)	Same as (B) above
AILERON III	(a)	Up and Down	Figure A5 Curve (5)	
WING FLAP IV	(a)	Up	Figure A5 Curve (4)	
	(b)	Down	0.25 x Up load (a)	
TRIM TAB V	(a)	Up and Down	Figure A5 Curve (3)	Same as (D) above
Note:	<p>The surface loadings I, II, III and V above are based on speeds <math>V_{Amin}</math> and <math>V_{Cmin}</math>. The loading of IV is based on <math>V_{Fmin}</math>. If values of speeds greater than these minimums are selected for design, the appropriate surface loadings must be multiplied by ratio <math>\left[ \frac{V_{selected}}{V_{minimum}} \right]^2</math>. For conditions I, II, III and V the multiplying factor used must be the higher of <math>\left[ \frac{V_{A sel.}}{V_{A min}} \right]^2</math> or <math>\left[ \frac{V_{C sel.}}{V_{C min}} \right]^2</math>.</p>			

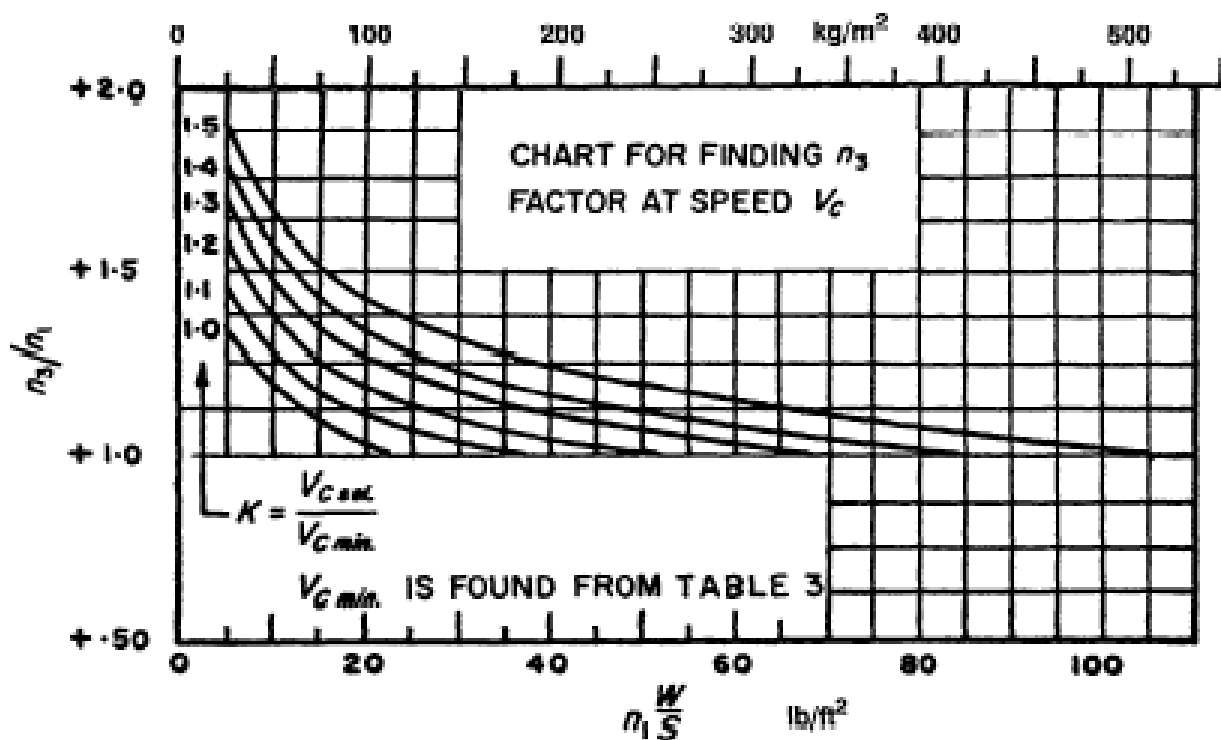

FIGURE A1  
CHART FOR FINDING  $n_3$  FACTOR AT SPEED  $V_c$ .

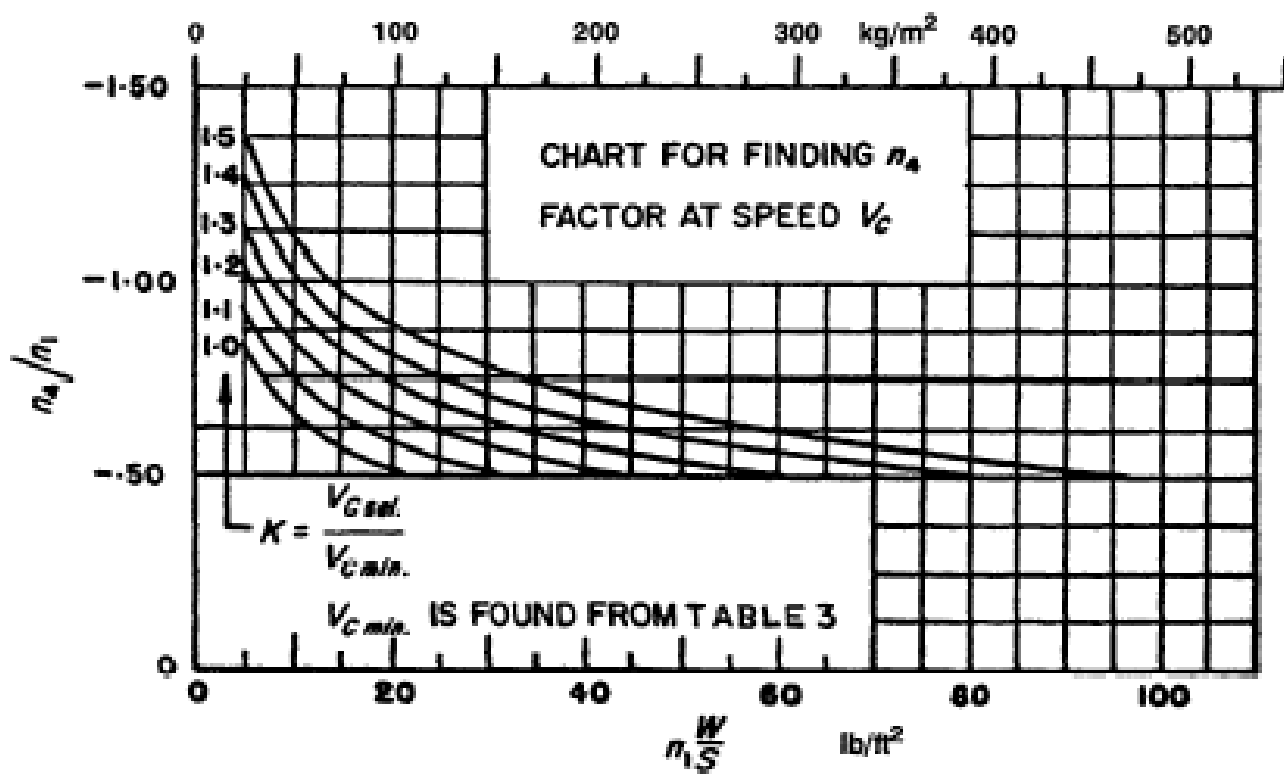

FIGURE A2  
CHART FOR FINDING  $n_4$  FACTOR AT SPEED  $V_c$ .

## CS-VLA BOOK 1

**Table 3 - Determination of minimum design speeds — Equations**

$V_{Dmin} = 10.86 \sqrt{n1 \frac{W}{S}} \quad \text{but need not exceed } 1.4 \sqrt{\frac{n1}{3.8}} V_{Cmin}$
$V_{Cmin} = 7.69 \sqrt{n1 \frac{W}{S}} \quad \text{but need not exceed } 0.9 V_H$
$V_{Amin} = 6.79 \sqrt{n1 \frac{W}{S}} \quad \text{but need not exceed } V_C \text{ used in design}$
$V_{Fmin} = 4.98 \sqrt{n1 \frac{W}{S}}$

(Speeds are in knots, W in kg, S in m<sup>2</sup>)

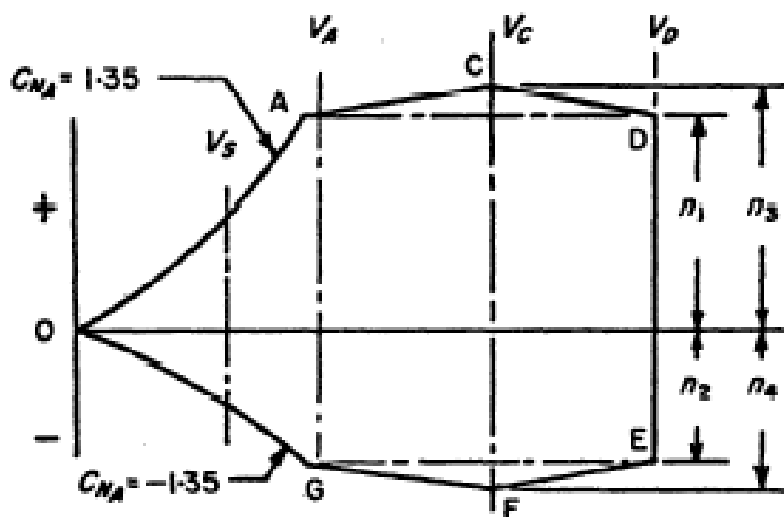

1. Conditions 'C' or 'F' need only be investigated when  $n_3 \frac{W}{S}$  or  $n_4 \frac{W}{S}$  is greater than  $n_1 \frac{W}{S}$  or  $n_2 \frac{W}{S}$ , respectively.
2. Condition 'G' need not be investigated when the supplementary condition specified in CS-VLA 369 is investigated.

**FIGURE A3  
FLIGHT ENVELOPE.**

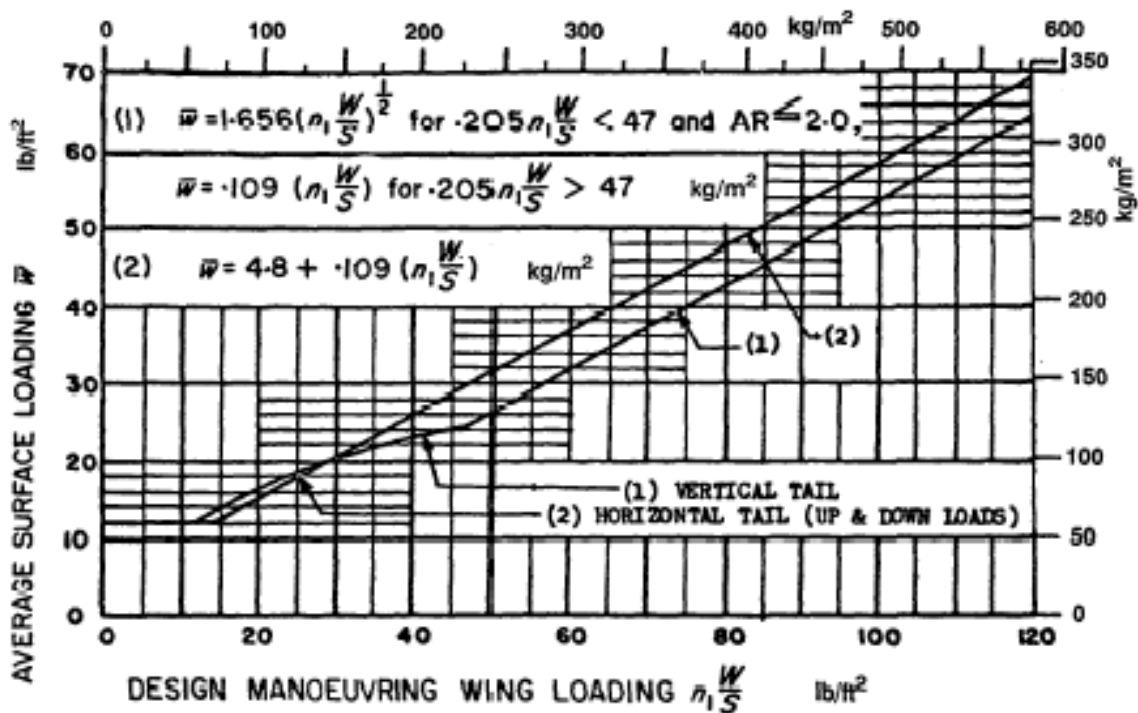

FIGURE A4  
AVERAGE LIMIT CONTROL SURFACE LOADING.

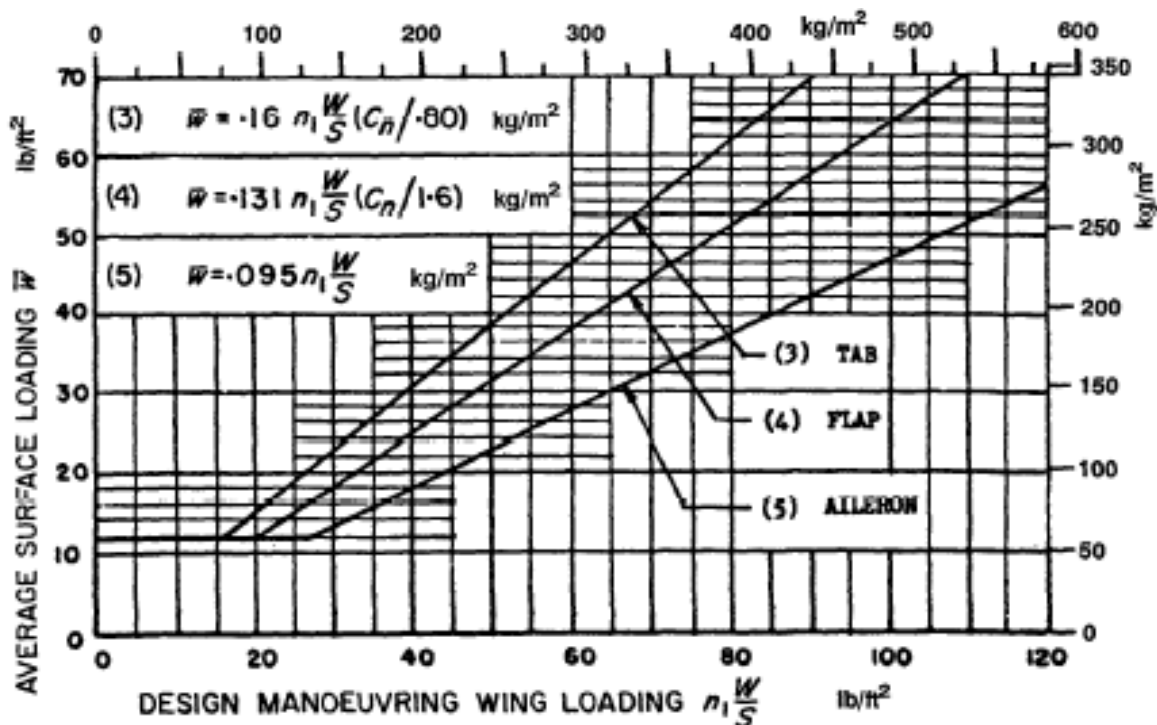

FIGURE A5  
AVERAGE LIMIT CONTROL SURFACE LOADING.



# CS-VLA BOOK 1

## APPENDIX B

### Control Surface Loadings

#### B1 General

(a) If allowed by the specific requirements in this CS-VLA, the values of control surface loading in this Appendix may be used to determine the detailed rational requirements of CS-VLA 397 to 459 unless the Agency finds that these values result in unrealistic loads.

(b) In the control surface loading conditions of paragraph B11, the airloads on the movable surfaces need not exceed those that could be obtained in flight by using the maximum limit pilot forces prescribed in CS-VLA 397 (b). If the surface loads are limited by these maximum limit pilot forces, the tabs must be deflected -

(1) To their maximum travel in the direction that would assist the pilot; or

(2) In an amount corresponding to the greatest degree of out-of-trim expected at the speed for the condition being considered.

(c) For a seaplane version of a landplane the landplane wing loadings may be used to determine the limit manoeuvring control surface loadings (in accordance with paragraph B11 and figure B1 of this Appendix) if -

(1) The power of the seaplane engine does not exceed the power of the landplane engine;

(2) The placard manoeuvre speed of the seaplane does not exceed the placard manoeuvre speed of the landplane;

(3) The maximum weight of the seaplane does not exceed the maximum weight of the landplane by more than 10%;

(4) The landplane service experience does not show any serious control-surface load problem; and

(5) The landplane service experience is of sufficient scope to ascertain with reasonable accuracy that no serious control-surface load problem will develop on the seaplane.

#### B11 Control surface loads

Acceptable values of limit average manoeuvring control-surface loadings may be obtained from figure B1 of this Appendix in accordance with the following:

(a) For horizontal tail surfaces -

(1) With the conditions in CS-VLA 423 (a)(i), obtain  $\bar{w}$  as a function of W/S and surface deflection, using -

(i) Curve C of figure B1 for a deflection of 10° or less;

(ii) Curve B of figure B1 for a deflection of 20°;

(iii) Curve A for a deflection of 30° or more;

(iv) Interpolation for all other deflections; and

(v) The distribution of figure B7; and

(2) With the conditions in CS-VLA 423 (a)(2), obtain  $\bar{w}$  from curve B of figure B1 using the distribution of figure B7.

(b) For vertical tail surfaces -

(1) With the conditions in CS-VLA 441 (a)(1), obtain  $\bar{w}$  as a function of W/S and surface deflection using the same requirements as used in sub-paragraphs (a)(1)(i) to (a)(1)(v) of this paragraph;

(2) With the conditions in CS-VLA 441 (a)(2), obtain  $\bar{w}$  from Curve C, using the distribution of figure B6; and

(3) With the conditions in CS-VLA 441 (a)(3), obtain  $\bar{w}$  from Curve A, using the distribution of figure B8.

(c) For ailerons, obtain  $\bar{w}$  from Curve B, acting in both the up and down directions, using the distribution of figure B9.

# CS-VLA BOOK 1

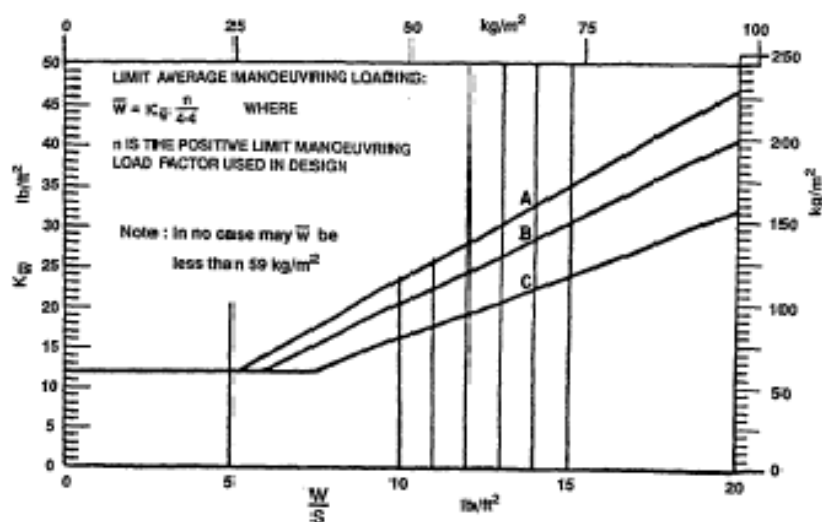

FIGURE B1 – LIMIT AVERAGE MANOEUVRING CONTROL SURFACE LOADING.

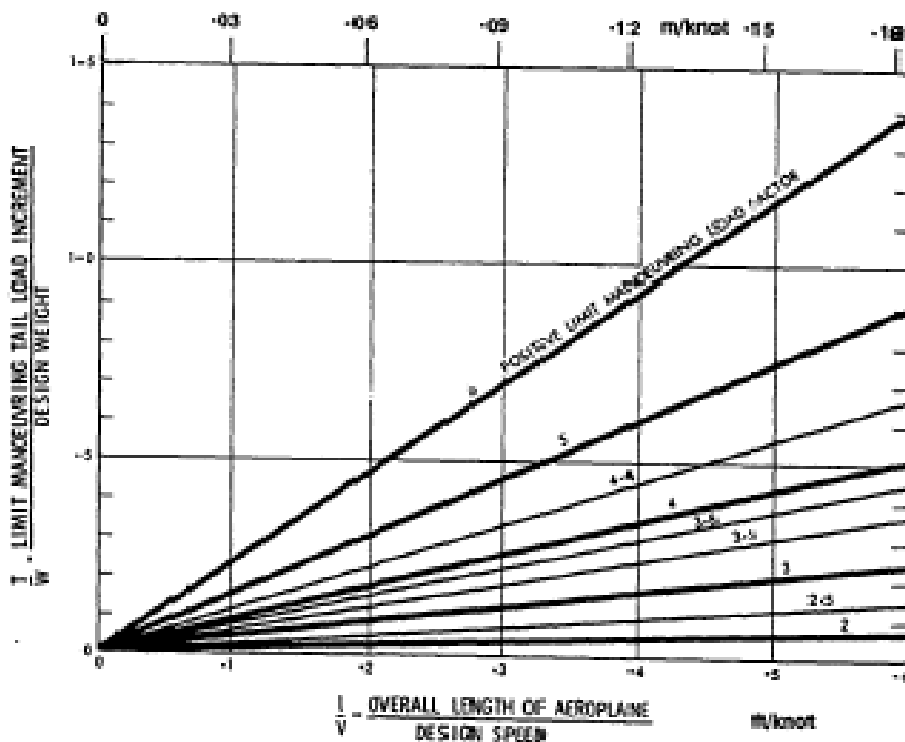

FIGURE B2 –MANOEUVRING TAIL LOAD INCREMENT (UP OR DOWN)

As an alternative to Figure B2, the following may be used:

$$\frac{T}{W} = \frac{k^2}{g l_t V} \times 20 \cdot 1 n_1(n_1 - 1 \cdot 5)$$

where:

- k is the radius of gyration of the aircraft in pitch
- l<sub>t</sub> is the distance between the aeroplane centre of gravity and the centre of the lift of the horizontal tail
- V is the aircraft speed in m/s.

CS-VLA BOOK 1

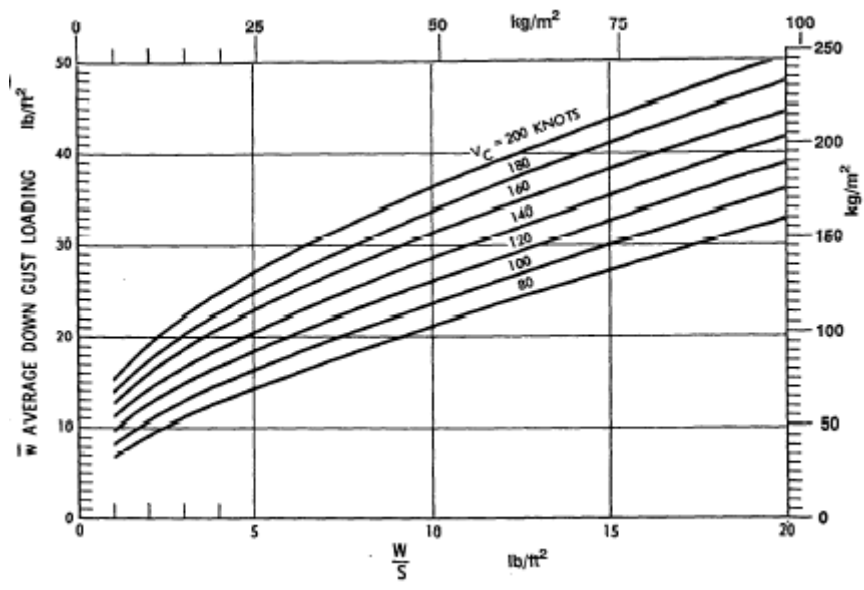

FIGURE B3  
UP AND DOWN GUST LOADING ON HORIZONTAL TAIL SURFACE.

FIGURE B4  
RESERVED.

# CS-VLA BOOK 1

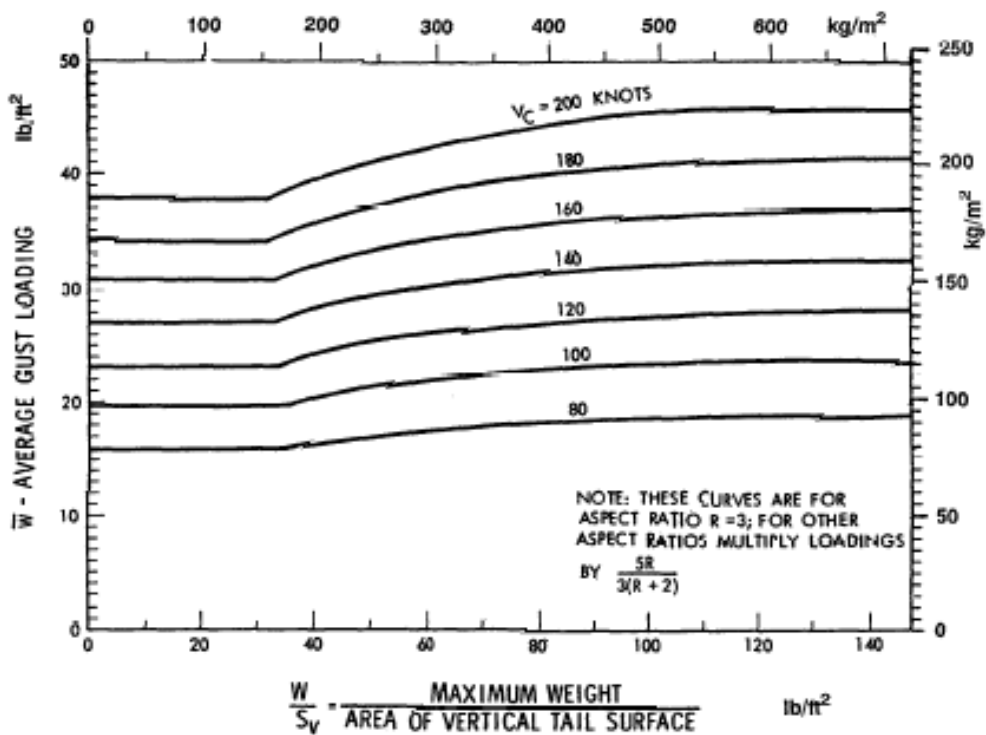

FIGURE B5 - GUST LOADING ON VERTICAL TAIL SURFACE.

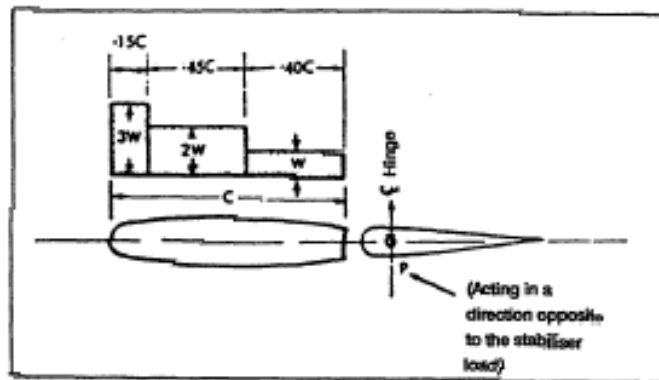

FIGURE B6 - TAIL SURFACE LOAD DISTRIBUTION.

NOTES:

(a) In balancing conditions in CS-VLA 421, P = 40% of net balancing load (flaps retracted); and P = 0 (flaps deflected).

(b) In the condition in CS-VLA 441 (a)(2), P = 20% of net tail load.

(c) The load on the fixed surface must be -

(1) 140% of the net balancing load for the flaps retracted case of note (a);

(2) 100% of the net balancing load for the flaps deflected case of note (a); and

(3) 120% of the net balancing load for the case in note (b).

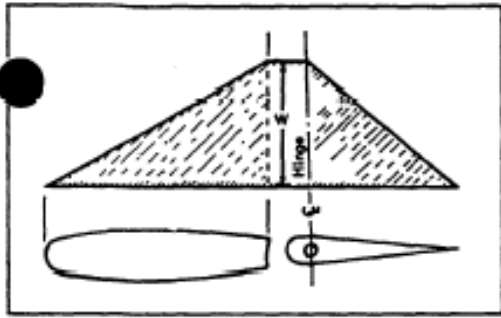

**FIGURE B7**  
**TAIL SURFACE LOAD DISTRIBUTION.**

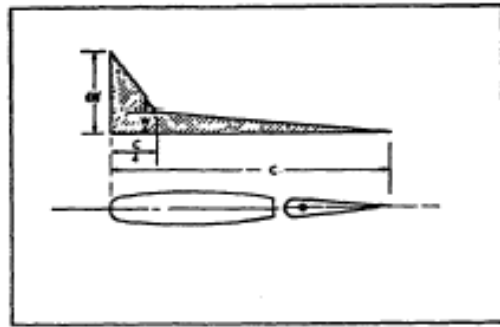

**FIGURE B8**  
**TAIL SURFACE LOAD DISTRIBUTION.**

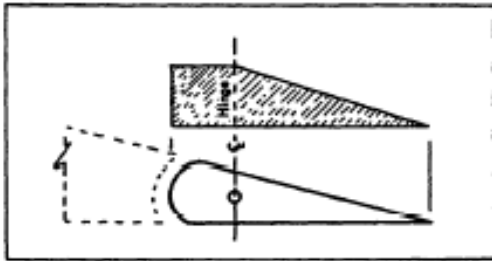

**FIGURE B9**  
**AILERON LOAD DISTRIBUTION.**

# CS-VLA BOOK 1

## Appendix C

### Basic Landing Conditions

Condition	Tail wheel type		Nose wheel type		
	Level landing	Tail-down landing	Level landing with inclined reactions	Level landing with nose wheel just clear of ground	Tail-down landing
Reference section-----	CS-VLA 479 (a)(1)	CS-VLA 481 (a)(1)	CS-VLA 479 (a)(2)(ii)	CS-VLA 479 (a)(2)(ii)	CS -VLA 481 (a)(2) and (b)
Vertical component at c.g.-----	nW	nW	nW	nW	nW
Fore and aft component at c.g. -----	KnW	0	KnW	KnW	0
Lateral component in either direction at c.g.--	0	0	0	0	0
Shock absorber extension (hydraulic shock absorber)-----	Note (2)	Note (2)	Note (2)	Note (2)	Note (2)
Shock absorber deflection (rubber or spring shock absorber)-----	100 %	100%	100%	100%	100%
Tyre deflection-----	Static	Static	Static	Static	Static
Main wheel loads (both wheels) ----- { Vr	(n-L)W	(n-L)Wb/d	(n-L)Wa'/d'	(N-LW	(n-L)W
----- { Dr	KnW	0	KnWa'/d'	KnW	0
Tail (nose) wheel loads ----- { Vf	0	(n-L)Wa/d	(n-L)Wb'/d'	0	0
----- { Df	0	0	KnWb'/d'	0	0
Notes -----	(1), (3), and (4)	(4)	(1)	(1), (3), and (4)	(3) and (4)

NOTES: (1) K may be determined as follows:  $K = 0.25$  for  $W = 1361$  kg or less;  $K = 0.33$  for  $W = 2722$  kg or greater, with linear variation of K between these weights.

(2) For the purpose of design, the maximum load factor is assumed to occur throughout the shock absorber stroke from 25% deflection to 100% deflection unless otherwise shown and the load factor must be used with whatever shock absorber extension is most critical for each element of the landing gear.

(3) Unbalanced moments must be balanced by a rational conservation method.

(4) L is defined in CS-VLA 725 e).

(5) n is the limit inertia load factor, at the c.g. of the aeroplane, selected under CS-VLA 473 (d), (f), and (g).

CS-VLA BOOK 1

TAIL WHEEL TYPE

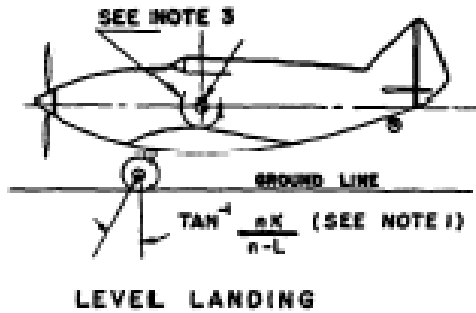

NOSE WHEEL TYPE

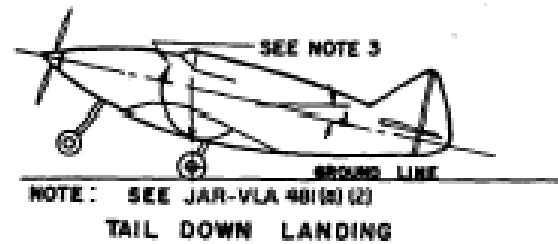
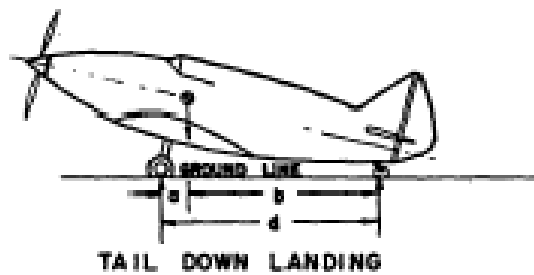
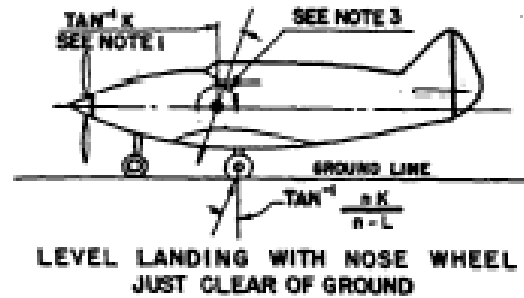
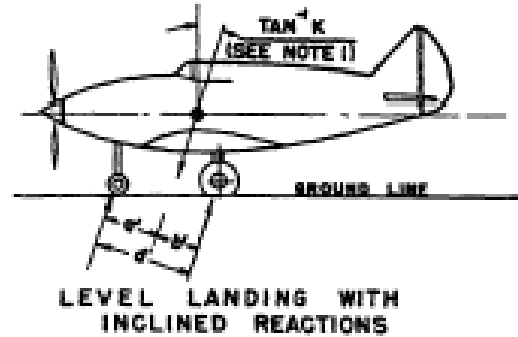

BASIC LANDING CONDITIONS

# BOOK 1 CS-VLA

## Appendix F

### Test Procedure For Self-Extinguishing Materials For Showing Compliance with CS-VLA 853 (e)

#### F1 Conditioning

Specimens must be conditioned to  $21^{\circ}\text{C} \pm 2.8^{\circ}\text{C}$  ( $70^{\circ}\text{F} \pm 5^{\circ}\text{F}$ ) and at  $50\% \pm 5\%$  relative humidity until moisture equilibrium is reached or for 24 hours. Only one specimen at a time may be removed from the conditioning environment immediately before subjecting it to the flame.

#### F2 Specimen configuration

Materials must be tested either as a section cut from a fabricated part as installed in the aeroplane or as a specimen simulating a cut section, such as a specimen cut from a flat sheet of the material or a model of the fabricated part. The specimen may be cut from any location in a fabricated part; however, fabricated units such as a sandwich panel, may not be separated for test. The specimen thickness must be no thicker than the minimum thickness to be qualified for use in the aeroplane, except that thick foam parts must be tested in 12.7 mm (0.5 inch) thickness. In the case of fabrics, both the warp and fill direction of the weave must be tested to determine the most critical flammability conditions. When performing the test prescribed in paragraph F4 of this Appendix, the specimen must be mounted in a metal frame so that -

- (a) The two long edges and the upper edge are held securely;
- (b) The exposed area of the specimen is at least 51 mm (2 inches) wide and 305 mm (12 inches) long, unless the actual size used in the aeroplane is smaller; and
- (c) The edge to which the burner frame is applied must not consist of the finished or protected edge of the specimen but must be representative of the actual cross section of the material or part installed in the aeroplane.

#### F3 Apparatus

Tests must be conducted in a draught-free cabinet in accordance with Federal Test Method

Standard 191 Method 5903 (revised Method 5902) which is available from the General Services Administration, Business Service Center, Region 3, Seventh and D Streets SW, Washington, D.C. 20407, or with some other approved equivalent method. Specimens which are too large for the cabinet must be tested in similar draught-free conditions.

#### F4 Vertical test

A minimum of three specimens must be tested and the results averaged. For fabrics, the direction of weave corresponding to the most critical flammability conditions must be parallel to the longest dimension. Each specimen must be supported vertically. The specimen must be exposed to a Bunsen or Tirrill burner with a nominal 9.5 mm (0.375 inch) I.D. tube adjusted to give a flame of 38.1 mm (1.5 inches) in height. The minimum flame temperature measured by a calibrated thermocouple pyrometer in the centre of the flame must be  $843^{\circ}\text{C}$  ( $1550^{\circ}\text{F}$ ). The lower edge of the specimen must be 19 mm (0.75 inch) above the top edge of the burner. The flame must be applied to the centre-line of the lower edge of the specimen. The flame must be applied for 60 seconds and then removed. Flame time, burn length, and flaming time of drippings, if any, must be recorded. The burn length determined in accordance with paragraph F5 of this Appendix must be measured to the nearest 2.5 mm (0.1 inch).

#### F5 Burn length

Burn length is the distance from the original edge to the farthest evidence of damage to the test specimen due to flame impingement, including areas of partial or complete consumption, charring, or embrittlement, but not including areas sooted, stained, warped, or discoloured, nor areas where material has shrunk or melted away from the heat source.



**CS-VLA BOOK 1**

## BOOK 2 CS-VLA

### **AMC VLA 1**

#### **Applicability (Interpretative Material)**

This CS-VLA is considered to be applicable to conventional aeroplanes. Some specific, non- conventional designs such as canards, tandem wings, winglets, may need additional requirements.

### **AMC VLA 21 (c)**

#### **Proof of Compliance (Interpretative Material)**

Whenever used, the sentence 'may not require exceptional piloting skill' should be interpreted to mean that it is no more than the skill expected from an average pilot.

### **AMC VLA 21 (d)**

#### **Proof of Compliance (Acceptable Means of Compliance)**

- 1 Performance and flight characteristics related to stalling speed, take-off , and climb should be investigated with a wet profile.
- 2 Although the performance may exceed the limits specified in CS-VLA 45, CS-VLA 51, CS-VLA 65, (dry conditions), the variations from those achieved in dry conditions should not exceed 9.3 km/h (5 kt) for  $V_{SO}$ , 50 m for take-off distance, 0.5 m/s (100 ft per min.) for rate of climb.
- 3 The test conditions should be such that the profile must remain wet throughout all of the test.

### **AMC VLA 23**

#### **Load Distribution Limits (Interpretative Material)**

- 1 The centre of gravity range within which the aeroplane may be operated safely without the use of removable ballast should not be less than that which corresponds to –
  - a. An occupant weight of 55 kg to 86 kg for single-seat aeroplanes.
  - b. An occupant weight of 55 kg to 172 kg for two-seat aeroplanes.
- 2 In each case the safe c.g. range should permit operation with a fuel load ranging from the lower limit of usable fuel up to fuel sufficient for one hour of operation at rated maximum continuous power.

### **AMC VLA 45**

#### **Performance, General (Acceptable Means of Compliance)**

- 1 The performance tests may be conducted in a non-standard atmosphere, not at sea level, and in non-still air. This requires testing procedures and data reduction methods that reduce the data to still air and standard sea level atmospheric conditions, where the performance must be met.
- 2 Data reduction should include corrections for engine power.

### **AMC VLA 173 and 175**

#### **Static Longitudinal Stability (Interpretative Material)**

Instrumented stick force measurements should be made unless –

- a. Changes in speed are clearly reflected by changes in stick forces; and
- b. The maximum forces obtained under CS-VLA 173 and 175 are not excessive.

## BOOK 2 CS-VLA

### AMC VLA 201

#### Wings Level Stall (Interpretative Material)

Yawing angles up to 5° should not appreciably change the stalling characteristics.

### AMC VLA 301 (d)

#### Loads (Interpretative Material)

A conventional configuration may be taken as an aeroplane with –

- a. A forward wing with an aft cruciform tail unit substantially separated in the fore and aft sense from the wing; and
- b. Whose lifting surfaces are either untapered or have essentially continuous taper with no more than 30° fore or aft sweep at the quarter chord line and equipped with trailing edge controls. Trailing edge flaps may be fitted.

NOTES: Configurations for which specific investigation is required include –

- (i) Canard, tandem-wing, close-coupled or tailless arrangements of the lifting surfaces;
- (ii) Cantilever bi-planes or multiplanes;
- (iii) T-tail or V-tail arrangements;
- (iv) Highly swept (more than 30° at quarter chord), delta or slatted lifting surfaces;
- (v) Winglets or other tip devices, including outboard fins.

### AMC VLA 307 (a)

#### Proof of Structure (Interpretative Material)

1 Substantiating load tests made in accordance with CS-VLA 307 (a) should normally be taken to ultimate design load.

2 The results obtained from strength tests should be so corrected for departures from the mechanical properties and dimensions assumed in the design calculations as to establish that the possibility of any structure having a strength less than the design value, owing to material and dimensional variation, is extremely remote.

### AMC VLA 405

#### Secondary Control System (Interpretative Material)

Single hand or foot loads assumed for design should not be less than the following:

- a. Hand loads on small hand-wheels, cranks, etc, applied by finger or wrist-force:  $P = 15 \text{ daN}$ .
- b. Hand loads on levers and hand-wheels applied by the force of an unsupported arm without making use of the body weight:  $P = 35 \text{ daN}$ .
- c. Hand loads on levers and hand-grips applied by the force of a supported arm or by making use of the body weight:  $P = 60 \text{ daN}$ .
- d. Foot loads applied by the pilot when sitting with his back supported (e.g. toe-brake operating loads):  $P = 75 \text{ daN}$ .

### AMC VLA 441

#### Manoeuvring Loads (Interpretative Material and Acceptable Means of Compliance)

For aeroplanes where the horizontal tail is supported by the vertical tail, the tail surfaces and their supporting structure including the rear portion of the fuselage should be designed to withstand the prescribed loadings on the vertical tail and the roll-moments induced by the horizontal tail acting in the same direction.

## BOOK 2 CS-VLA

2 For T-tails in the absence of a more rational analysis, the rolling moment induced by deflection of the vertical rudder may be computed as follows:

$$M_r = 0.3 S_t \frac{\rho_o}{2} \beta V^2 b_H$$

where –

$M_r$  = induced roll-moment at horizontal tail (Nm)

$b_H$  = span of horizontal tail (m)

$\beta$  = angle of zero lift line due to rudder deflection

$$\beta = \frac{dL}{d\eta} \eta f_\eta$$

$\eta$  = rudder deflection

$\frac{dL}{d\eta}$  = change of zero lift angle of  $\eta f_\eta = 1$

$f_\eta$  = effectivity factor in accordance with angle of rudder deflection

$V$  = speed of flight (m/s)

$S_t$  = area of horizontal tail (m<sup>2</sup>)

$\rho_o$  = air density at sea level (kg/m<sup>3</sup>)

### AMC VLA 443

#### Gust Loads (Interpretative Material and Acceptable Means of Compliance)

1 For aeroplanes where the horizontal tail is supported by the vertical tail, the tail surfaces and their supporting structure including the rear portion of the fuselage should be designed to withstand the prescribed loadings on the vertical tail and the roll-moments induced by the horizontal tail acting in the same direction.

2 For T-tails in the absence of a more rational analysis, the rolling moment induced by gust load may be computed as follows:

$$M_r = 0.3 S_t \frac{\rho_o}{2} V U b_H K$$

where –

$M_r$  = induced roll-moment at horizontal tail (Nm)

$K$  = gust factor = 1.2

$b_H$  = span of horizontal tail (m)

$S_t$  = area of horizontal tail (m<sup>2</sup>)

$\rho_o$  = density of air at sea level (kg/m<sup>3</sup>)

$V$  = speed of flight (m/s)

$U$  = gust speed (m/s)

### AMC VLA 479(b)

#### Level Landing Conditions (Acceptable Means of Compliance)

'Properly combined' may be defined by a rational analysis or as follows:

a. Max spin-up condition –

$$P_z = 0.6 P_z \text{ max}; P_x = -0.5 P_z \text{ max.}$$

b. Max spring back condition –

$$P_z = 0.8 P_z \text{ max}; P_x = 0.5 P_z \text{ max.}$$

c. Max vertical load condition –

$$P_z = P_z \text{ max}; P_x = \pm 0.3 P_z \text{ max.}$$

## BOOK 2 CS-VLA

where –

P<sub>x</sub> = horizontal component of ground reaction

P<sub>z</sub> = vertical component of ground reaction.

### AMC VLA 572 (a)

#### Parts of Structure Critical to Safety (Interpretative Material)

At least the wing main spar, the horizontal tail and their attachments to the fuselage should be investigated to determine whether or not their stress levels exceed the values given in the table in AMC VLA 572 (b).

### AMC VLA 572 (b)

#### Parts of Structure Critical to Safety (Interpretative Material and Acceptable Means of Compliance)

1 The use of the following stress levels may be taken as sufficient evidence, in conjunction with good design practices to eliminate stress concentrations, that structural items have adequate safe lives:

Material used	Allowable normal stress level of maximum limit load
– Glass rovings in epoxy resin	25 daN/mm <sup>2</sup>
– Carbon fibre rovings in epoxy resin	40 daN/mm <sup>2</sup>
– Wood	According to ANC-18*
– Aluminium Alloy	Half of rupture tensile strength
– Steel Alloy	Half of rupture tensile strength

2 Higher stress levels need further fatigue investigation using one or a combination of the following methods:

- a. By a fatigue test, based on a realistic operating spectrum.
- b. By a fatigue calculation using strength values which have been proved to be sufficient by fatigue tests of specimens or components.

\*ANC-18 is the ANC Bulletin 'Design of wood aircraft structures'; issued June 1944 by the Army-Navy-Civil Committee on Aircraft Design Criteria (USA).

### AMC VLA 613 (b)

#### Material Strength Properties and Design Values (Interpretative Material)

Material specifications should be those contained in documents accepted either specifically by the Agency or by having been prepared by an organisation or person which the Agency accepts has the necessary capabilities. In defining design properties these material specification values should be modified and/or extended as necessary by the constructor to take account of manufacturing practices (for example method of construction, forming, machining and subsequent heat treatment).

### AMC VLA 613 (c)

#### Material Strength Properties and Design Values (Acceptable Means of Compliance)

Test Temperature –

## BOOK 2 CS-VLA

a. For white painted surface and vertical sunlight: 54°C. If the test cannot be performed at this temperature an additional factor of 1.25 should be used.

b. For other coloured surfaces the curve below may be used to determine the test temperature.

Curve based on: NASA Conference Publication 2036  
NASA Contractor Report 3290

### AMC VLA 615

#### Design Properties (Acceptable Means of Compliance)

When the manufacturer is unable to provide satisfactory statistical justification for A and B values, especially in the case of manufacturing of composite materials, a safety super factor should be applied to ensure that A and B values are met.

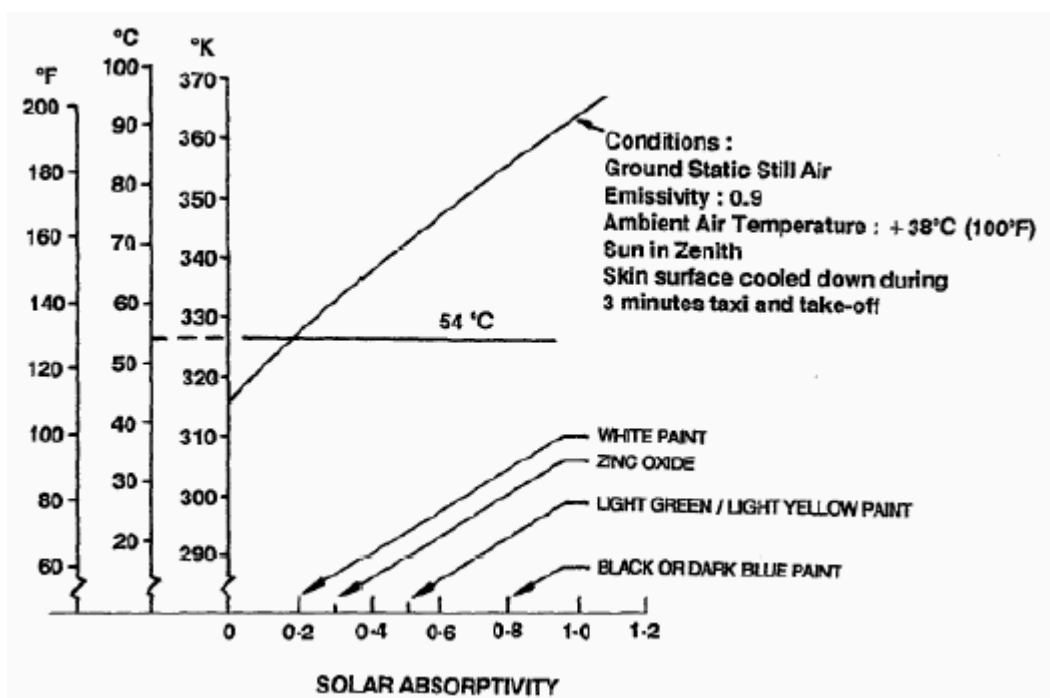

## BOOK 2 CS-VLA

### AMC VLA 619

#### Special Factors (Acceptable Means of Compliance)

For the substantiation of composite structures, unless more rational means are agreed by the Agency, one of the following may be used:

- a. An additional factor of 1.2 for moisture conditioned specimen tested at maximum service temperature, providing that a well established manufacturing and quality control procedure is used.
- b. An additional factor of 1.5 for specimen tested with no specific allowance for moisture and temperature.

- NOTES: 1 For cold cured structures it may be assumed that the completed structure is fully moisture conditioned.
- 2 The factor in a. above may be varied based on the coefficient of variation that the manufacturer is able to show for this product. (See Table 1.)

TABLE 1

Coefficient of Variation %	Test Factor
5	1.00
6	1.03
7	1.06
8	1.10
9	1.12
10	1.15
12	1.22
14	1.30
15	1.33
20	1.55

Definition: Coefficient of Variation

For a population with mean M and standard deviation s, the coefficient of variation, Cv, is defined by-

$$Cv = \sigma/M$$

The coefficient of variation is frequently expressed as a percentage, in which case

$$Cv (\%) = 100 \sigma/M$$

Additional Advisory Material:

When the population coefficient of variation is estimated from tests of critical structural features, the results from tests of at least 6 specimens should be used.

The sample coefficient of variation should be adjusted to obtain a 95% confidence estimate of the population coefficient of variation which may be used in Table 1.

In the absence of a more rational method, this may be done by multiplying the sample coefficient of variation by a Factor F, defined by –

## BOOK 2 CS-VLA

$$F = \frac{1 + U_p \left\{ \frac{1}{2f} \left( 1 - \frac{c^2 U_p^2}{n} \right) + \frac{c^2}{n} \right\}^{1/2}}{1 - \frac{c^2 U_p^2}{n}}$$

where –

$U_p$  is the standardised normal variate corresponding to the confidence level being used (for 95% confidence,  $U_p = 1.6452$ )

$n$  is the number of specimens in the Sample

$f$  is the number of statistical degree of freedom [= (n-1)]

$c$  is the population coefficient of variation. The value of the factor  $F$  is relatively relatively insensitive to the value of  $c$  used – in the absence of more rational data, a value of 0.2 should be used.

### AMC VLA 773

#### Pilot Compartment View (Acceptable Means of Compliance)

Compliance with CS-VLA 773 may be provided by the canopy having a suitable opening.

### AMC VLA 775 (a)

#### Windshields and Windows (Acceptable Means of Compliance)

Windshields and windows made of synthetic resins are accepted as complying with this requirement.

### AMC VLA 777

#### Cockpit Controls (Interpretative Material)

The pilot should not need to change the hand operating the primary controls in order to operate a secondary control during critical stages of the flight (e.g. during take-off and landing).

### AMC VLA 785 (e)

#### Seats, Safety Belts and Harnesses (Acceptable Means of Compliance)

*Installation of shoulder harness.* Figures 1(a), 1(b) and 1(c) show the recommended installation geometry for this type of restraint.

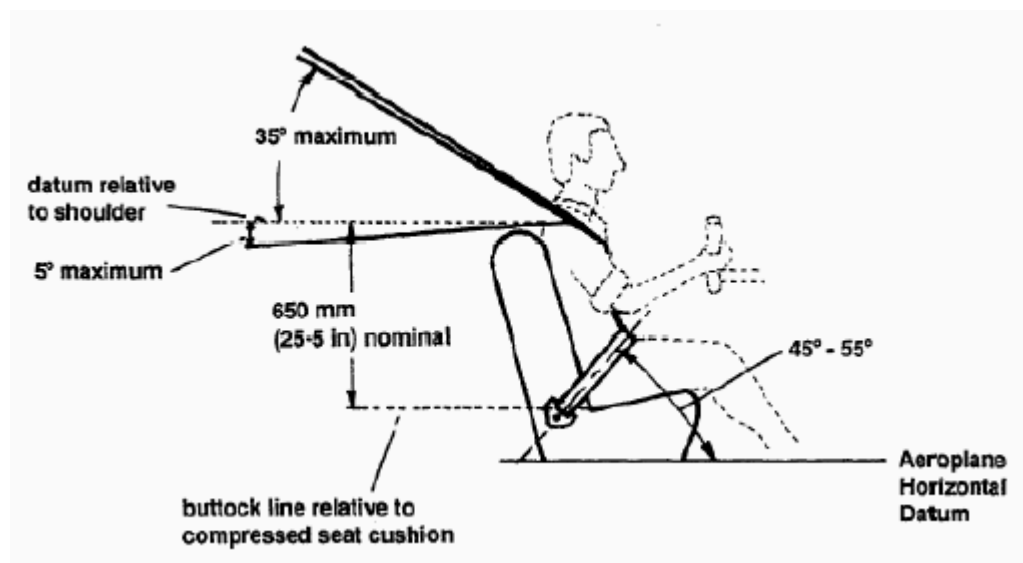

FIGURE 1(a)



## BOOK 2 CS-VLA

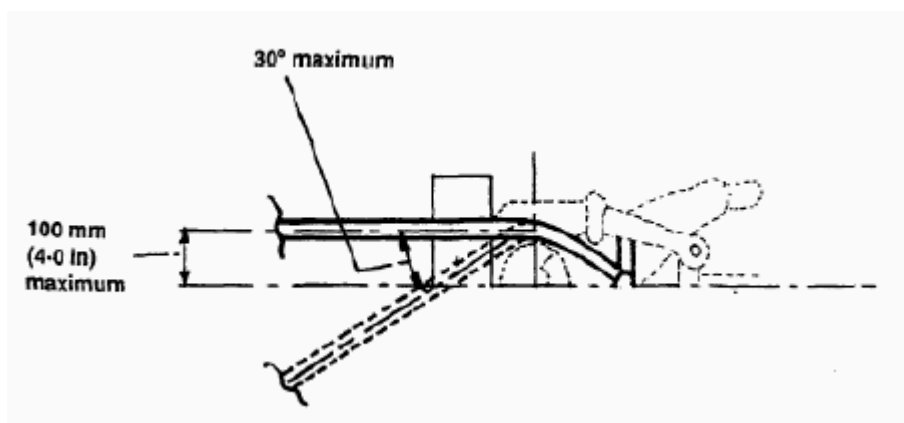

FIGURE 1(b)

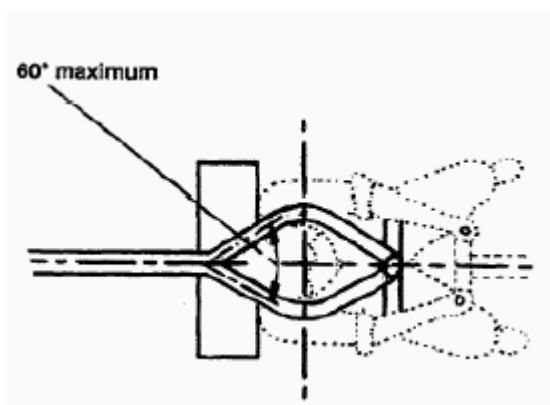

FIGURE 1(c)

- NOTES:
- 1 Where possible it is recommended that a negative g or crotch strap is fitted, otherwise during abrupt decelerations the shoulder straps tend to raise the belt portion (unless tightly adjusted) from around the hips onto the stomach, thus allowing the wearer to slide underneath the lap portion of the belt.
  - 2 Where there is more than 152 mm (6 in) of webbing between the attachment point of the shoulder straps, and the top of the seat back, suitable means should be provided to limit sideways movement e.g. guide loops, in order to ensure compliance with CS-VLA 785 (e) and to ensure adequate separation of shoulder straps to minimise injury or chafing of the wearer's neck.
  - 3 Where the seat back is of adequate strength and such height that the harness geometry relative to the shoulder conforms with Figure 1(a) (i.e. 650 mm (25.5 in)), it is permissible to attach the shoulder straps to the seat back or via guide loops to the aeroplane floor.
  - 4 Where the seat back is of adequate strength the use of means, e.g. guide loop of suitable strength, will limit sideways movement during the emergency alighting accelerations of CS-VLA 561 (b)(2).

*Safety belt with one diagonal shoulder strap (ODS Safety Belt).* Figures 2(a) and 2(b) show the recommended installation geometry for this type of restraint.

BOOK 2 CS-VLA

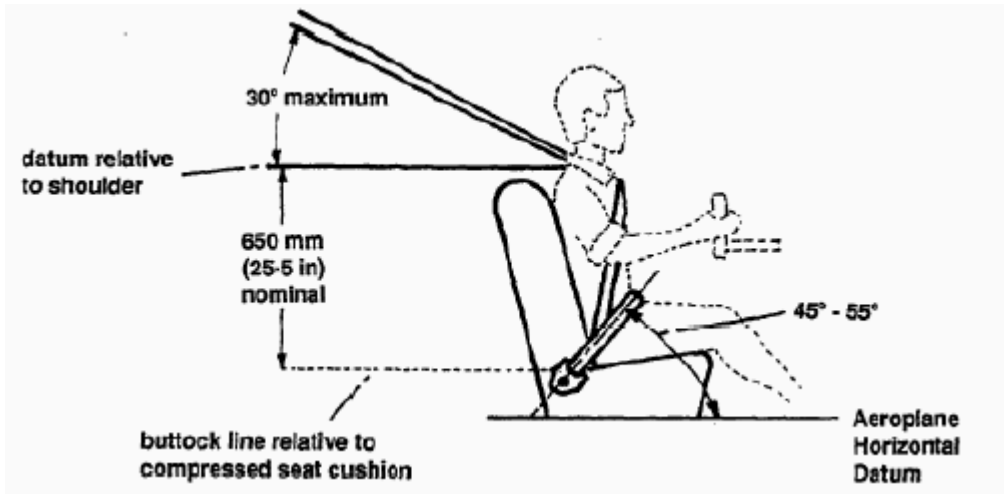

FIGURE 2(a)

## BOOK 2 CS-VLA

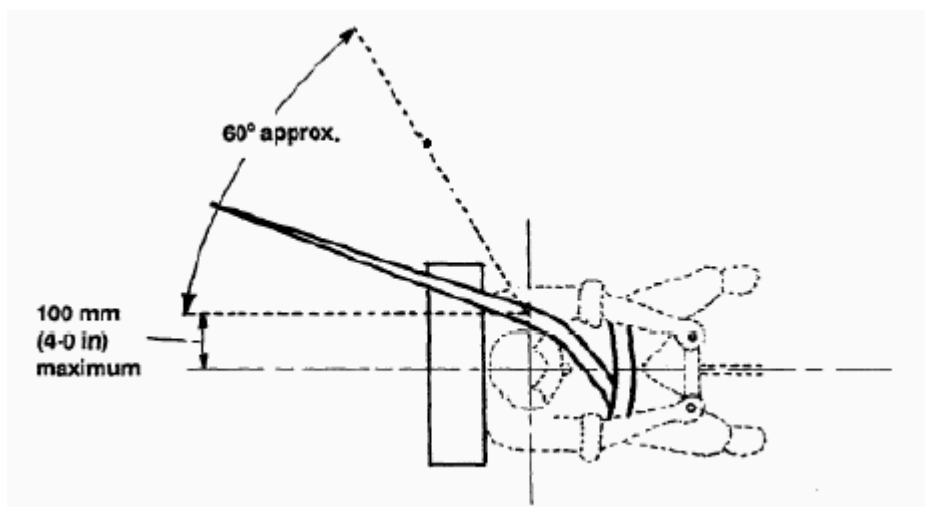

FIGURE 2(b)

- NOTES:
- 1 The total length of the diagonal shoulder strap should be kept as short as possible in order to reduce the effect of webbing stretch under the emergency alighting loads.
  - 2 Where the seat back is of adequate strength and such height that the harness geometry relative to the shoulder conforms with the Figure 2(a) (i.e. 650 mm (25.5 in)), it is permissible to attach the shoulder strap to the seat back or via guide loops to the aeroplane floor.
  - 3 The installation should be such as to minimise the risk of injury or chafing of the wearer's neck, a guide loop may assist in achieving this.

### **AMC VLA 807(a) Emergency Exits**

Unless it is determined that a design is not susceptible to turnover, the inverted position (turnover) should be considered probable. If escape in an inverted position is not obvious or is questionable, provisions should be made in the basic aircraft design to allow the occupants to make a rapid escape from a turnover position. This may include the design of the emergency exit or fuselage, the use of materials which are readily breakable or by installing weak points in the fuselage or canopy.

As an alternative to provisions within the basic aircraft design, it is acceptable to install qualified escape equipment (e.g. crash axe) that would permit the occupant(s) to make a rapid escape from the inverted position. In order to qualify escape equipment, it must be shown by test or by similarity with previous tests, that the equipment can perform its intended function.

[Amdt VLA/1]

### **AMC VLA 903 (a) Engines (Acceptable Means of Compliance)**

Engines certificated under CS-E are accepted as complying with CS-22 Subpart H.

### **AMC VLA 905 (a) Propellers (Acceptable Means of Compliance)**

Propellers certificated under CS-P are accepted as complying with CS-22 Subpart J.

## BOOK 2 CS-VLA

### **AMC VLA 943**

#### **Negative Acceleration (Acceptable Means of Compliance)**

Compliance with CS-VLA 943 may be shown by submitting the aeroplane to such period of negative acceleration that is within the capability of the aeroplane, but not less than –

- a. One continuous period of 2 seconds at less than zero 'g'; and separately,
- b. At least two excursions to less than zero 'g' in rapid succession in which the total time at less than zero 'g' is at least 2 seconds.

### **AMC VLA 1011 (c)**

#### **Oil System, General (Interpretative Material)**

In assessing the reliance that can be placed upon the means for providing the appropriate fuel/oil mixture to the engine to prevent a hazardous condition, account should be taken of, for example –

- a. The tolerance of the engine to fuel/oil mixture ratios other than the optimum;
- b. The procedure established for refuelling and introducing the appropriate amount of oil; and
- c. The means by which the pilot may check that the fuel contains an adequate mixture of oil.

### **AMC VLA 1105 (b)**

#### **Induction System Screens (Acceptable Means of Compliance)**

The de-icing of the screen may be provided by heated air.

### **AMC VLA 1305 (a)**

#### **Powerplant Instruments (Interpretative Material)**

A single indicator is acceptable for each group of interconnected tanks functioning as a single tank, such that individual tanks cannot be isolated.

### **AMC VLA 1436**

#### **Hydraulic Manually-Powered Brake Systems (Interpretative Material)**

For hydraulic systems other than manually-powered brake systems the requirement of CS 23.1435 should be applied.

### **AMC VLA 1587 (a)(4)**

#### **Performance Information (Interpretative Material)**

The variation in aerodrome altitude to be covered need not exceed from sea level to the smaller of 2 438 m (8 000 ft), and the altitude at which a steady rate of climb of 1.02 m/s (200 ft per min.) may be achieved. The temperature variations to be covered at each altitude need not exceed 33°C below standard to 22°C above standard.

### **AMC VLA 1581**

#### **Specimen Flight Manual For A Very Light Aeroplane**

See following pages.

**BOOK 2 CS-VLA**

**Model:**

**Serial No:**

**Registration:**

**Document No. (If appropriate):**

**Date of Issue:**

**Pages identified by 'Appr.' are approved by:**

**Signature:**

**Agency:**

**Stamp:**

**Original date of approval:**

**This aeroplane is to be operated in compliance with information and limitations contained herein.**

## BOOK 2 CS-VLA

(Model Designation or Document No.)

### H0.1 *Record of revisions*

Any revision of the present manual, except actual weighing data, must be recorded in the following table and in case of approved Sections endorsed by the Agency.

The new or amended text in the revised pages will be indicated by a black vertical line in the left hand margin, and the Revision No. and the date will be shown on the bottom left hand side of the page.

Rev. No	Affected Section	Affected Pages	Date	Approval	Date	Date Inserted	Signature

## BOOK 2 CS-VLA

(Model Designation or Document No.)

### H0.2 *List of Effective Pages*

Section	Page	Date	Section	Page	Date
0	(i)				
	(ii)				
	(iii)				
1	1.1				
	1.2				
	1.3				
2	2.1				
	Appr. 2.2				
	Appr. 2.3				
	Appr. 2.4				
	Appr. 2.5				
3	3.1				
	Appr. 3.2				
etc					

## BOOK 2 CS-VLA

(Model Designation or Document No.)

### H0.3 *Table of Contents*

Section	
General (a non-approved section)	1
Limitations (an approved section)	2
Emergency procedures (an approved section)	3
Normal procedures (an approved section)	4
Performance (a partly approved section)	5
Weight and balance/equipment list (a non-approved section)	6
Aircraft and systems description (a non-approved section)	7
Aircraft handling, servicing and maintenance (a non-approved section)	8
Supplements	9



## **BOOK 2 CS-VLA**

**(Model Designation or Document No.)**

### **Section 1**

H1 General

H1.1 Introduction

H1.2 Certification basis

H1.3 Warnings, cautions and notes

H1.4 Descriptive data

H1.5 Three-view drawing

## BOOK 2 CS-VLA

(Model Designation or Document No.)

### H1.1 Introduction

The aeroplane Flight Manual has been prepared to provide pilots and instructors with information for the safe and efficient operation of this very light aeroplane.

This manual includes the material required to be furnished to the pilot of CS-VLA. It also contains supplemental data supplied by the aeroplane manufacturer.

### H1.2 Certification basis

This type of aircraft has been approved by the European Aviation Safety Agency in accordance with CS-VLA including Amendment ..... and the Type Certificate No. ....has been issued on (date ) .....

Category of Airworthiness: Normal

Noise Certification Basis: .....

### H1.3 Warnings, cautions and notes

The following definitions apply to warnings, cautions and notes used in the flight manual.

**WARNING:** means that the non-observation of the corresponding procedure leads to an immediate or important degradation of the flight safety.

**CAUTION:** means that the non-observation of the corresponding procedure leads to a minor or to a more or less long term degradation of the flight safety.

**NOTE:** draws the attention to any special item not directly related to safety but which is important or unusual.

### H1.4 Descriptive data

(Kind of very light aeroplane)

(Design details)

(Engine and propeller)

(Span, length, height, MAC, wing area, wing loading)

### H1.5 Three-view drawing

## **BOOK 2 CS-VLA**

**(Model Designation or Document No.)**

### **Section 2**

H2 Limitations

H2.1 Introduction

H2.2 Airspeed

H2.3 Airspeed indicator markings

H2.4 Powerplant

H2.5 Powerplant instrument markings

H2.6 Miscellaneous instrument markings

H2.7 Weight

H2.8 Centre of gravity

H2.9 Approved manoeuvres

H2.10 Manoeuvring load factors

H2.11 Flight crew

H2.12 Kinds of operation

H2.13 Fuel

H2.14 Maximum passenger seating

H2.15 Other limitations

H2.16 Limitation placards

## BOOK 2 CS-VLA

(Model Designation or Document No.)

### H2.1 Introduction

Section 2 includes operating limitations, instrument markings, and basic placards necessary for safe operation of the aeroplane, its engine, standard systems and standard equipment.

The limitations included in this section and in Section 9 have been approved by European Aviation Safety Agency.

### H2.2 Airspeed

Airspeed limitations and their operational significance are shown below -

	Speed	(IAS)	Remarks
V <sub>NE</sub>	Never exceed speed		Do not exceed this speed in any operation
V <sub>NO</sub>	Maximum structural cruising speed		Do not exceed this speed except in smooth air, and then only with caution.
V <sub>A</sub>	Manoeuvring speed		Do not make full or abrupt control movement above this speed, because under certain conditions the aircraft may be overstressed by full control movement.
V <sub>FE</sub>	Maximum Flap Extended speed (if applicable give different flap settings)		Do not exceed these speeds with the given flap setting.
V <sub>LO</sub>	Maximum Landing Gear Operating Speed		Do not extend or retract the landing gear above this speed.
V <sub>LE</sub>	Maximum Landing Gear Extended Speed		Do not exceed this speed with the landing gear extended.

## BOOK 2 CS-VLA

(Model Designation or Document No.)

### H2.3 Airspeed indicator markings

Airspeed indicator markings and their colour-code significance are shown below -

Marking	(IAS) value or range	Significance
White arc		<i>Positive Flap Operating Range.</i> (Lower limit is maximum weight $1.1 V_{SO}$ in landing configuration. Upper limit is maximum speed permissible with flaps extended positive.)
Green arc		<i>Normal Operating Range.</i> Lower limit is maximum weight $1.1 V_{S1}$ at most forward c.g. with flaps and landing gear retracted (if retractable). Upper limit is maximum structural cruising speed.
Yellow arc		Manoeuvres must be conducted with caution and only in smooth air.
Red line		Maximum speed for all operations

### H2.4 Powerplant

Engine Manufacturer:

Engine Model:

Maximum Power, Take-off:

Continuous:

Maximum Engine rpm at MSL, Take-off:

Continuous:

Maximum Cylinder Head Temperature:

Maximum Oil Temperature:

Oil Pressure, Minimum:

Maximum:

Fuel pressure, Minimum:

Maximum:

Fuel Grade (Specification):

Oil Grade (Specification):

Propeller Manufacturer:

Propeller Model:

## BOOK 2 CS-VLA

(Model Designation or Document No.)

Propeller Diameter, Minimum:

Maximum:

Propeller Blade Angle (at 75% station), low:

high:

Propeller Rotational speed restrictions (if applicable):

### H2.5 *Powerplant instrument markings*

Powerplant instrument markings and their colour code significance are shown below:

Instrument	Red Line Minimum Limit	Green Arc Normal Operating (range)	Yellow Arc Caution Range	Red Line Maximum Limit
Tachometer	---	(range)	(range)	
Oil Temperature	---		---	
Cylinder head temperature	---		---	
Fuel pressure		---	---	
Oil pressure			---	
Fuel quantity		---	---	---
	(unusable fuel mark)			

### H2.6 *Miscellaneous instrument markings*

(Limitations and markings for miscellaneous instruments, such as vacuum pressure instrument gauge, must be provided, as appropriate.)

### H2.7 *Weight*

Maximum Take-off weight:

Maximum Landing weight:

Maximum Zero Fuel weight:

Maximum weight in Baggage Compartment:

### H2.8 *Centre of gravity*

Centre of gravity range (specified for Minimum Flight Weight up to Maximum Take-off weight)

Reference datum

### H2.9 *Approved manoeuvres*

This aeroplane is certified in the Normal Category.

(Manoeuvres which are approved must be listed herein with the appropriate entry speeds).

## BOOK 2 CS-VLA

(Model Designation or Document No.)

### H2.10 *Manoeuvring load factors*

(Maximum positive and negative load factors under different conditions must be listed herein.)

### H2.11 *Flight crew*

(A statement of the minimum crew must be provided.)

### H2.12 *Kinds of operation*

(Herein must be listed the approved kinds of operation according to CS-VLA 1525 and the minimum equipment required for each kind of operation.)

### H2.13 *Fuel*

(Tank capacity)

Total fuel:

Usable fuel

Unusable fuel:

Approved fuel grades:

(Special instructions for fuel management)

(Special instructions for fuel/oil-mixing in case of two-stroke engine.)

### H2.14 *Maximum passenger seating*

(Any limit of number or weight of passengers should be stated.)

### H2.15 *Other limitations*

(Provide a statement of any limitations required, but not specifically covered in this Section.)

### H2.16 *Limitation placards*

(The operating limitation placard required in CS-VLA 1559 should be illustrated.)

Remark: For further placards refer to Maintenance Manual Doc. No. ....

## **BOOK 2 CS-VLA**

**(Model Designation or Document No.)**

### **Section 3**

H3 Emergency procedures (approved)

H3.1 Introduction

H3.2 Engine failure (carburettor icing)

H3.3 Air start

H3.4 Smoke and fire

H3.5 Glide

H3.6 Landing emergency

H3.7 Recovery from unintentional spin

H3.8 Other emergencies



## BOOK 2 CS-VLA

(Model Designation or Document No.)

### H3.1 *Introduction*

Section 3 provides checklist and amplified procedures for coping with emergencies that may occur. Emergencies caused by aeroplanes or engine malfunction are extremely rare if proper preflight inspections and maintenance are practised.

However, should an emergency arise, the basic guidelines described in this section should be considered and applied as necessary to correct the problem.

### H3.2 *Engine failure*

(Procedures should be provided for all cases of engine failure during take-off and flight.)

### H3.3 *Air start*

(Procedures should be provided for starting the engine in flight and, if the engine does not start, for subsequent actions. The altitude and speed range for air start of the engine should be indicated.)

### H3.4 *Smoke and fire*

(Procedures should be provided for coping with cases of smoke or fire in the cabin or in the engine compartment in the following flight phases:

- (a) On ground
- (b) During take-off
- (c) In flight.)

### H3.5 *Glide*

(Information and procedures should be provided for a gliding descent, including:

The recommended airspeed,

The associated configuration, and

The distance from a specified height above ground that an aeroplane will glide or the glide ratio.)

### H3.6 *Landing emergencies*

(Procedures should be provided for the various landing emergencies under the following conditions:

- (a) Precautionary landings
- (b) With a flat tyre
- (c) With a defective landing gear
- (d) With power, landing gear retracted
- (e) Without power, landing gear retracted
- (f) Approach and landings with flaps retracted, if flapless landings require any special technique.)

## BOOK 2 CS-VLA

(Model Designation or Document No.)

### H3.7 *Recovery from unintentional spin*

(The spin recovery procedure should be explained, other than for those aeroplanes which have been shown to be 'characteristically incapable of spinning'. A discussion of prevention of spins should be included with the statement that the aeroplane is not approved for spins.)

### H3.8 *Other emergencies*

(Emergency procedures and other pertinent information necessary for safe operations should be provided for emergencies peculiar to a particular aeroplane design, operating or handling characteristics.)

## **BOOK 2 CS-VLA**

**(Model Designation or Document No.)**

### **Section 4**

H4 Normal procedures

H4.1 Introduction

H4.2 Rigging and derigging (if appropriate)

H4.3 Daily inspection

H4.4 Preflight inspection

H4.5 Normal procedures and check list

## BOOK 2 CS-VLA

(Model Designation or Document No.)

### H4.1 *Introduction*

Section 4 provides checklist and amplified procedures for the conduct of normal operation. Normal procedures associated with optional systems can be found in Section 9.

H4.2 to H4.4	}	(Description of the steps which are necessary for rigging and inspections.)
--------------------	---	---

### H4.5 *Normal procedures and checklist*

(This chapter should contain the recommended normal procedures for the following phases of flight after the performed preflight inspection listed under 4.4:

- (a) Before starting engine
- (b) Use of external power
- (c) Engine starting
- (d) Before taxiing
- (e) Taxiing
- (f) Check before take-off
- (g) Take-off
- (h) Climb
- (i) Cruise
- (j) Descent
- (k) Check before landing
- (l) Balked landing
- (m) After landing
- (n) Engine shutdown
- (o) Postflight ELT

If take-off, flight and landing characteristics are different in rain this should be specially stated herein.)

## **BOOK 2 CS-VLA**

**(Model Designation or Document No.)**

### **Section 5**

H5 Performance (partly approved)

H5.1 Introduction

H5.2 Approved data

H5.2.1 Airspeed indicator system calibration

H5.2.2 Stall speeds

H5.2.3 Take-off performance

H5.2.4 Landing distances

H5.2.5 Climb performance

H5.3 Additional information

H5.3.1 Cruise

H5.3.2 Endurance

H5.3.3 Balked landing climb

H5.3.4 Take-off measurements

H5.3.5 Effect on flight performance and characteristics

H5.3.6 Demonstrated crosswind performance

H5.3.7 Noise data

## BOOK 2 CS-VLA

(Model Designation or Document No.)

(

### H5.1 *Introduction*

Section 5 provides approved data for airspeed calibration, stall speeds and take-off performance and non-approved additional information.

The data in the charts has been computed from actual flight tests with the aeroplane and engine in good condition and using average piloting techniques.

### H5.2 *Approved data*

#### H5.2.1 Airspeed indicator system calibration

(The data should be presented as Calibrated Airspeed (CAS) versus Indicated Airspeed (IAS) assuming zero instrument error. The presentation should include all flap setting configurations and should cover the appropriate speed operating range.)

#### H5.2.2 Stall speed

(The data should be presented as indicated airspeed and calibrated airspeed versus flap setting configurations and angle of bank at maximum weight with throttle closed. Altitude loss of more than 30 m and pitch below the horizon of more than thirty degrees during recovery from stalls should be added if applicable.)

#### H5.2.3 Take-off performance

(Ground roll distance and take-off distance over a 15 m obstacle should be presented as distance versus outside air temperature, altitude and wind. The speeds required to attain these distances should be scheduled in indicated airspeed (IAS). The presentation should incorporate the calculated approximate effect on take-off performances of temperature and altitude.)

#### H5.2.4 Landing distances

(The ground roll distance and the landing distance over a 15 m obstacle should be presented as distance versus outside temperature, altitude and wind. The speed(s) at the 15 m height point required to obtain the distances should be included. The presentation should incorporate the calculated approximate effect on landing performances of temperature and altitude.)

#### H5.2.5 Climb performance

(The data should be presented as rate-of-climb, versus outside air temperature and altitude at maximum take-off weight and maximum continuous power (MCP).

Climb speeds should be either the best rate-of-climb speeds or an average best rate-of-climb speed and scheduled in indicated airspeed (IAS).)

### H5.3 *Additional information*

#### H5.3.1 Cruise

(The data should be presented as engine power settings and true air speed (TAS) versus altitude and temperature.)

#### H5.3.2 Endurance

(The data should be presented as endurance time of aeroplane versus altitude for various power settings and at least a full fuel loading.)

## BOOK 2 CS-VLA

(Model Designation or Document No.)

### H5.3.3 Balked landing climb.

(The data should be presented as rate-of-climb versus outside temperature and altitude at maximum landing weight and maximum take-off power with flaps in full extended position and landing gear retracted (if appropriate).)

### H5.3.4 Take off measurement from a dry, short-mown grass surface.

### H5.3.5 Effect on flight performances and characteristics caused by rain or accumulation of insects.

### H5.3.6 Demonstrated crosswind performance.

(The maximum crosswind speed at which landings have been demonstrated should be presented.)

### H5.3.7 Noise data.

(The noise data, approved according to the environmental rules, should be presented.)

## **BOOK 2 CS-VLA**

**(Model Designation or Document No.)**

### **Section 6**

H6 Weight and balance

H6.1 Introduction

H6.2 Weight and balance record and permitted payload range



## BOOK 2 CS-VLA

(Model Designation or Document No.)

### H6.1 Introduction

This section contains the payload range within which the aeroplane may be safely operated.

Procedures for weighing the aircraft and the calculation method for establishing the permitted payload range and a comprehensive list of all equipment available for this aircraft and the installed equipment during the weighing of the aircraft are contained in the applicable Maintenance Manual Doc. No. ....

### H6.2 Weight and balance record permitted payload range

Permitted crew + passenger weight with																
Date	Empty weight	c.g. pos	Max. baggage ..... kg				Half baggage ..... kg				No baggage				Approved	
			Front seat		Rear seat		Front seat		Rear seat		Front seat		Rear seat			
			Max.	Min.	Max.	Min.	Max.	Min.	Max.	Min.	Max.	Min.	Max.	Min.	Max.	Min.
EXAMPLE FOR A TANDEM SEATER AIRCRAFT																

Condition: Aircraft in the range from max. fuel of ..... kg to min. Fuel of .....kg.

For calculation of max. and min. Crew + passenger weight refer to Maintenance Manual Doc. No. ....

Permitted crew + passenger weight with										
Date	Empty weight	c/g pos	Max. baggage ..... kg		Half baggage ..... kg		No baggage		Approved	
			Maximum	Minimum	Maximum	Minimum	Maximum	Minimum		
EXAMPLE FOR A SIDE-TO-SIDE SEATER AIRCRAFT										

Condition: Aircraft in the range from max. fuel of ..... kg to min. Fuel of .....kg.

For calculation of max. and min. Crew + passenger weight refer to Maintenance Manual Doc. No. ....

## **BOOK 2 CS-VLA**

**(Model Designation or Document No.)**

### **Section 7**

H7 Aeroplane and system description

H7.1 Introduction

H7.2 Airframe

H7.3 Flight controls (including Flap and Trim)

H7.4 Instrument panel

H7.5 Landing gear system

H7.6 Seats and safety harness

H7.7 Baggage compartment

H7.8 Doors, windows and exits

H7.9 Powerplant

H7.10 Fuel system

H7.11 Electrical system

H7.12 Pitot and static pressure systems

H7.13 Miscellaneous equipment

H7.14 Avionics

## BOOK 2 CS-VLA

(Model Designation or Document No.)

### H7.1 *Introduction*

This section provides description and operation of the aeroplane and its systems. Refer to Section 9, Supplements, for details of optional systems and equipment.

### H7.2 *Airframe*

(Describe structure of fuselage, wings and empennage.)

### H7.3 *Flight controls*

(Describe control surfaces, including flaps.  
Describe operating mechanism - sketches may be provided.  
Explain trimming arrangements.  
Explain any interconnect arrangement.)

### H7.4 *Instrument panel*

(Provide a drawing or picture of the instrument panel.  
Name and explain the use of the instruments, lights, controls, switches and circuit breakers installed on or near the panel.)

### H7.5 *Landing gear system*

(Describe construction.  
Describe retraction mechanism if provided.  
Describe brake system.  
Describe emergency extension system if provided.)

### H7.6 *Seats and safety harness*

(Describe how to adjust the seats.  
Describe how to use the safety harness.)

### H7.7 *Baggage compartment*

(Describe location and tie down provisions.  
Explain restrictions regarding weight and kind of baggage.)

### H7.8 *Doors, windows and exits*

(Describe how to operate and lock doors, windows and exits.  
Explain how to close a door or window if it opens unintentionally in flight and any restrictions necessary.  
Explain the use of emergency exits.)

### H7.9 *Powerplant*

(Describe the engine, the engine controls ' and instrumentation. Describe the propeller and explain how the propeller should operate.)

## BOOK 2 CS-VLA

(Model Designation or Document No.)

### *H7.10 Fuel system*

(Describe the system by a good schematic and explain the operation.  
Explain unusable fuel.  
Explain the fuel measuring system and the fuel venting system.  
Explain how to avoid and notice fuel contamination.)

### *H7.11 Electrical system*

(Describe the system by use of simplified schematics.  
Explain how this system operates including warning and control devices.  
Explain circuit protection.  
Discuss capacity and load shedding.)

### *H7.12 Pilot and static pressure systems*

(Describe pitot and static pressure systems.)

### *H7.13 Miscellaneous equipment*

(Describe important equipment not already covered.)

### *H7.14 Avionics*

(Describe items installed by the aircraft manufacturer and explain their functions and how they are operated.)

## **BOOK 2 CS-VLA**

**(Model Designation or Document No.)**

### **Section 8**

H8 Aeroplane handling, servicing and maintenance

H8.1 Introduction

H8.2 Aeroplane inspection periods

H8.3 Aeroplane alterations or repairs

H8.4 Ground handling/Road transport

H8.5 Cleaning and care

## BOOK 2 CS-VLA

(Model Designation or Document No.)

### *H8.1 Introduction*

This section contains factory-recommended procedures for proper ground handling and servicing of the aeroplane. It also identifies certain inspection and maintenance requirements which must be followed if the aeroplane is to retain that new-plane performance and dependability. It is wise to follow a planned schedule of lubrication and preventive maintenance based on climatic and flying conditions encountered.

### *H8.2 Aeroplane inspection period*

(Reference to Maintenance Manual of the aeroplane.)

### *H8.3 Aeroplane alterations or repairs*

It is essential that the Agency be contacted prior to any alterations on the aeroplane to ensure that airworthiness of the plane is not violated. For repairs refer to the applicable Maintenance Manual Doc. No. ,... ..

### *H8.4 Ground handling/ Road transport (f applicable)*

(Explain the following procedures:

- (a) Towing
- (b) Parking
- (c) Mooring
- (d) Jacking
- (e) Levelling
- (f) Road transport (if applicable) including disassembling for road transport and assembling after road transport.)

### *H8.5 Cleaning and care*

(Describe cleaning procedures for the following aircraft items:

- (a) Painted exterior surfaces
- (b) Propeller
- (c) Engine
- (d) Interior surfaces, seats and carpets,

and explain the recommended cleaning agents and give caution notes, if necessary.)

## **BOOK 2 CS-VLA**

**(Model Designation or Document No.)**

### **Section 9**

H9 Supplements

H9.1 Introduction

H9.2 List of inserted supplements

H9.3 Supplements inserted

## BOOK 2 CS-VLA

(Model Designation or Document No.)

### H9.1 *Introduction*

This section contains the appropriate supplements necessary to safely and efficiently operate the aeroplane when equipped with various optional systems and equipment not provided with the standard aeroplane.

### H9.2 *List of inserted supplements*

Date	Doc. No.	Title of the inserted supplement



## BOOK 2 CS-VLA

(Model Designation or Document No.)

### *H9.3 Supplements inserted*

(Each supplement should normally cover only a single system, device or piece of equipment such as an autopilot, ski or navigation system. The supplement may be issued by the aeroplane manufacturer or by any other manufacturer of the applicable item.

The supplement must be approved by the Agency and must contain all deviations and changes relative to the basic Flight Manual.

Each supplement should be a self-contained, miniature Flight Manual with at least the following:

#### Section 1 General

The purpose of the supplement and the system or equipment to which it specifically applies should be stated.

#### Section 2 Limitations

Any change to the limitations, markings or placards of the basic Flight Manual should be stated. If there is no change, a statement to that effect should be made.

#### Section 3 Emergency procedures

Any addition or change to the basic emergency procedures of the Flight Manual should be stated. If there is no change, a statement to that effect should be made.

#### Section 4 Normal procedures

Any addition or change to the basic normal procedures of the Flight Manual should be stated. If there is no change, a statement to that effect should be made.

#### Section 5 Performance

Any effect of the subject installation upon aeroplane performance as shown in the basic Flight Manual should be indicated. If there is no change, a statement to that effect should be made.

#### Section 6 Weight and balance

Any effect of the subject installation upon weight and balance of the aeroplane should be indicated. If there is no change, a statement to that effect should be made.)