

European Aviation Safety Agency

Certification Specifications
for
Sailplanes
and
Powered Sailplanes

CS-22

Amendment 2
5 March 2009

CONTENTS**CS-22****Sailplanes and Powered Sailplanes****PREAMBLE****BOOK 1 – AIRWORTHINESS CODE**

- SUBPART A — GENERAL
- SUBPART B — FLIGHT
- SUBPART C — STRUCTURE
- SUBPART D — DESIGN AND CONSTRUCTION
- SUBPART E — POWER-PLANT
- SUBPART F — EQUIPMENT
- SUBPART G — OPERATING LIMITATIONS AND INFORMATION
- SUBPART H — ENGINES
- SUBPART J — PROPELLERS
- APPENDIX F — GLOSSARY OF AEROBATIC MANOEUVRES
- APPENDIX G — COCKPIT PLACARDS
- APPENDIX I — SELF-SUSTAINING POWERED SAILPLANES
- APPENDIX J — PROCESS OF H-POINT DETERMINATION
- APPENDIX K — AEROTOWING OF SAILPLANES BY POWERED SAILPLANES

BOOK 2 – ACCEPTABLE MEANS OF COMPLIANCE (AMC):

- SUBPART A — GENERAL
- SUBPART B — FLIGHT
- SUBPART C — STRUCTURE
- SUBPART D — DESIGN AND CONSTRUCTION
- SUBPART E — POWER-PLANT
- SUBPART F — EQUIPMENT
- SUBPART G — OPERATING LIMITATIONS AND INFORMATION
- SUBPART H — ENGINES
- SUBPART J — PROPELLERS
- APPENDIX K — AEROTOWING OF SAILPLANES BY POWERED SAILPLANES

PREAMBLE***CS-22 Amendment 1 Effective: 01/10/2008***

The following is a list of paragraphs affected by this amendment.

Book 1Subpart C

- CS 22.561 Amended (NPA 2007-12)

Subpart D

- CS 22.785 Amended (NPA 2007-12)
- CS 22.787 Amended (NPA 2007-12)

Book 2Subpart C

- AMC 22.561 Created (NPA 2007-12)
- AMC 22.561(b)(2) Created (NPA 2007-12)

Subpart D

- AMC 22.785(f) Amended (NPA 2007-12)

CS-22 Amendment 2 Effective: 05/03/2009

The following is a list of paragraphs affected by this amendment.

Book 1Subpart D

- CS 22.807 Amended (NPA 2008-11)

Book 2Subpart D

- AMC 22.807(a) Created (NPA 2008-11)

EASA Certification Specifications
for
SAILPLANES AND POWERED SAILPLANES

CS-22
Book 1

Airworthiness code

Subpart A – General**CS 22.1 Applicability**
(See AMC 22.1)

(a) This Airworthiness Code is applicable to sailplanes and powered sailplanes in the utility U and aerobatic A categories:–

(1) sailplanes the maximum weight of which does not exceed 750 kg;

(2) single engined (spark- or compression-ignition) powered sailplanes the design value W/b^2 (weight to span²) of which is not greater than $3(W[\text{kg}], b[\text{m}])$ and the maximum weight of which does not exceed 850 kg; and

(3) sailplanes and powered sailplanes the number of occupants of which does not exceed two.

(b) Reserved

(c) Those requirements in this CS–22 which apply only to powered sailplanes are marginally annotated with the letter P. Requirements not so marked apply both to sailplanes and to powered sailplanes with engines stopped and engine or propeller retracted where appropriate. In these requirements the word ‘sailplane’ means both ‘sailplane’ and ‘powered sailplane’.

(d) Unless specifically stated otherwise, the term ‘powered sailplane’ includes those powered sailplanes which may be incapable of complying with CS 22.51 and/or CS 22.65(a) and which must consequently be prohibited from taking off solely by means of their own power by a limitation in the Flight Manual. These are referred to in the text as ‘Self-Sustaining Powered Sailplanes’. For Self-Sustaining Powered Sailplanes the additional requirements in Appendix I are applicable.

CS 22.3 Sailplane categories
(See AMC 22.3)

(a) The Utility Category is limited to sailplanes intended for normal soaring flight. The following aerobatic manoeuvres may be permitted if demonstrated during type certification –

(1) spins;

(2) lazy eights, chandelles, stall turns and steep turns;

(3) positive loops.

(b) Sailplanes intended for aerobatic manoeuvres additional to those permitted in the Utility Category must be certificated in the Aerobatic Category. The permitted aerobatic manoeuvres must be established during type certification.

(c) Sailplanes may be certified in more than one category if the requirements of each requested category are met.

(d) Powered sailplanes may be used for aerotowing sailplanes if they comply with Appendix K.

Subpart B – Flight**GENERAL****CS 22.21 Proof of compliance**
(See AMC 22.21)

(a) Each requirement of this Subpart must be met at each appropriate combination of weight and c.g. within the range of loading conditions for which certification is requested. This must be shown:

(1) by test upon a sailplane of the type for which certification is requested or by calculations based on and equal in accuracy to the result of testing; and,

(2) by systematic investigation of each critical combination of weight and c.g.

(b) Compliance must be established for all configurations (such as position of air brakes, wing-flaps, landing gear etc.) at which the sailplane will be operated except as otherwise stated. In demonstrating compliance, the power-plant or propeller, if retractable, must be retracted, except as otherwise stated.

CS 22.23 Load distribution limits
(See AMC 22.23)

(a) The ranges of weight and c.g. within which the sailplane may be safely operated must be established and must include the range for lateral c.g. if possible loading conditions can result in significant variation. Compliance must be shown over the lateral c.g. range and over a longitudinal c.g. range between the foremost limit of the c.g. and 1% of the standard mean chord or 10 mm, whichever is greater, aft of the aftmost limit of the c.g.

(b) The c.g. range must not be less than that which corresponds to the weight of each occupant, including parachute, varying between 110 kg and 70 kg, without the use of ballast as defined in CS 22.31(c).

CS 22.25 Weight limits

(a) *Maximum weight.* The maximum weight must be established so that it is:

(1) Not more than:

(i) the highest weight selected by the applicant;

(ii) the design maximum weight, which is the highest weight at which compliance with each applicable structural loading condition of this Part is shown; or

(iii) the highest weight at which compliance with each applicable flight requirement of this Part is shown.

(2) Not less than the weight which results from the empty weight of the sailplane, plus a weight of occupant(s) and parachute(s) of 110 kg for a single seat sailplane or 180 kg for a two seat sailplane, plus the required minimum equipment, plus any expendable ballast and for a powered sailplane sufficient fuel for at least half an hour of flight at maximum continuous power.

(b) The minimum weight must be established so that it is not more than the sum of:

(1) the empty weight determined under CS 22.29; and

(2) a weight of occupant and parachute of 55 kg, plus any ballast as defined in CS 22.31(c).

CS 22.29 Empty weight and corresponding c.g.

(a) The empty weight and corresponding c.g. must be determined by weighing the sailplane:

(1) with:

(i) fixed ballast;

(ii) required minimum equipment;

(iii) for a powered sailplane, unusable fuel, maximum oil and, where appropriate, engine coolant and hydraulic fluid.

(2) excluding:

(i) weight of occupant(s) and parachute(s);

(ii) other readily removable items of load.

(b) The condition of the sailplane at the time of determining empty weight must be one that is well defined and easily repeated.

CS 22.31 Ballast

There are three types of ballast:

(a) fixed ballast intended for correcting a deficiency in the sailplane's balance;

(b) expendable ballast which can be jettisoned in flight and which serves to increase the weight and consequently the speed of the sailplane; and

(c) removable ballast used to supplement the weight of an occupant and parachute (when lower than 70 kg) in order to keep the c.g. position within limits. This ballast can be adjusted before, but not during, flight.

PERFORMANCE**CS 22.45 General**

Compliance with performance requirements of this Subpart must be shown for still-air in standard atmosphere and at sea-level.

CS 22.49 Stalling speed

(a) V_{S0} is the stalling speed (CAS), if obtainable, or the minimum steady speed at which the sailplane is controllable, with:

- (1) landing gear extended;
- (2) wing-flaps in the landing position;
- (3) air brakes retracted or extended whichever position results in the lowest value of V_{S0} ;
- (4) maximum weight; and
- (5) c.g. in the most unfavourable position within the allowable range.
- (6) For a powered sailplane:
 - (i) the engine idling (throttle closed);
 - (ii) propeller in the take-off position;
 - (iii) cowl flaps closed.

(b) The stalling speed in the landing configuration must not exceed:

- (1) 80 km/h with:
 - (i) air brakes retracted; and at
 - (ii) maximum weight with water ballast tanks empty.

(2) 90 km/h with:

- (i) airbrakes retracted, and at
- (ii) maximum weight with water ballast.

(3) 95 km/h with:

- (i) airbrakes fully extended; and at
- (ii) maximum weight with water ballast.

(c) V_{S1} is the stalling speed (CAS), if obtainable, or the minimum steady speed at which the sailplane is controllable with the:

(1) sailplane in the configuration existing in the test in which V_{S1} is being used; and

(2) weight used when V_{S1} is being used as a factor to determine compliance with a required performance standard.

(3) For a powered sailplane:

- (i) the engine idling (throttle closed);
- (ii) propeller in the take-off position;
- (iii) cowl flaps closed.

(d) Reserved.

(e) V_{S0} and V_{S1} must be determined by flight tests using the procedure specified in CS 22.201.

CS 22.51 Take-off

(a) For a powered sailplane the take-off distance at maximum weight and in zero wind, from rest to attaining a height of 15 m must be determined and must not exceed 500 m when taking off from a dry, level, hard surface. In demonstration of the take-off distance, the powered sailplane must be allowed to reach the selected speed promptly after lifting off and this speed must be maintained throughout the climb.

(b) The selected speed must not be less than;

- (1) $1.3 V_{S1}$, or
- (2) any lesser speed, not less than $1.15 V_{S1}$, that is shown to be safe under all reasonably expected operating conditions,

including turbulence and complete engine failure.

CONTROLLABILITY AND MANOEUVRABILITY

CS 22.65 Climb

(a) For a powered sailplane the time for climb from leaving the ground up to 360 m above the field must not exceed four minutes with:

- (1) not more than take-off power;
- (2) landing gear retracted;
- (3) wing-flaps in take-off position;
- (4) cowl flaps (if any) in the position used in the cooling tests.

(b) For self-sustaining powered sailplanes, the maximum altitude that can be sustained must be determined.

CS 22.71 Rate of descent

For a powered sailplane the smallest rate of descent in power-off configuration at maximum weight and most unfavourable c.g. position must not exceed the following limits:

- (a) with a single-seater powered sailplane, 1.0 m/s;
- (b) with a two-seater powered sailplane, 1.2 m/s.

CS 22.73 Descent, high speed

It must be shown that the sailplane with the airbrakes extended, will not exceed V_{NE} in a dive at an angle to the horizon of:

- (a) 45° when the sailplane is approved for cloud flying and/or aerobatics when certificated in the Aerobatic or Utility Category;
- (b) in other cases
 - (i) 30°
 - (ii) less than 30° when a rate of descent of more than 30 m/s can be achieved.

CS 22.75 Descent, approach

It must be shown that the sailplane has a glide slope not flatter than one in seven at a speed of 1.3 V_{S0} with air brakes extended at maximum weight.

CS 22.143 General

(a) It must be possible to make a smooth transition from one flight condition to another (including turns and slips) without exceptional piloting skill, alertness or strength, and without danger of exceeding the limit load factor, under any probable operating condition, and, additionally, in the case of a powered sailplane, with the engine running at all allowable power settings. (See AMC 22.143 (a))

(b) Any unusual flying characteristics observed during the flight tests required to determine compliance with the flight requirements and any significant variations in flight characteristics caused by rain must be determined. In the case of a powered sailplane this requirement must be met with the engine running at all allowable powers. (See AMC 22.143 (b))

(c) If marginal conditions exist with regard to required pilot strength, the 'strength of pilots' limits must be shown by quantitative tests. In no case may the limits exceed those prescribed in the following table. In the case of a powered sailplane this requirement must be met with the engine running at all allowable powers.

Force applied at hand grip or rudder pedal	Pitch	Roll	Yaw	Air brakes, towing, release, wing-flaps, landing gear
	daN	daN	daN	daN
(a) temporary application hand feet	20	10	40	20
(b) prolonged application hand feet	2.0	1.5	10	

CS 22.145 Longitudinal control

(a) It must be possible at any speed below $1.3 V_{S1}$ to pitch the nose downwards so that a speed equal to $1.3 V_{S1}$ can be reached promptly.

(1) Test conditions: all possible configurations and trimmed at $1.3 V_{S1}$.

(b) It must be possible throughout the appropriate flight envelope to change the configuration (landing gear, air brakes, wing-flaps etc.) without exceptional piloting skill and without exceeding the control forces defined in CS 22.143(c).

(c) It must be possible, without exceptional piloting skill, to maintain the sailplane in steady straight flight:

(1) in towed flight, when the wing-flap configuration is changed within the range of permissible flap settings during steady straight flight;

(2) when retraction or extension of the airbrakes is made at speeds between $1.1 V_{S1}$ and $1.5 V_{S1}$, where V_{S1} is the stalling speed with airbrakes retracted or extended, whichever is the higher, for a given flap position.

(3) when gradual change of the wing-flap configuration within the range of permissible flap settings is made during steady horizontal flight at $1.1 V_{S1}$ with

simultaneous application of maximum continuous power.

CS 22.147 Lateral and directional control

Using an appropriate combination of controls it must be possible to reverse the direction of a turn with a 45° bank in the opposite direction within $b/3$ seconds (b is the span in metres) when the turns are made at a speed of $1.4 V_{S1}$ with wing-flaps in the most positive en-route position, air brakes and, where applicable, landing gear retracted and without significant slip or skid.

CS 22.151 Aerotowing

(a) If the sailplane is equipped for aerotowing, aerotows must be demonstrated at speeds up to V_T without:

(1) excessive control forces and displacements for maintaining the wings at zero bank angle and in keeping a steady flight path;

(2) control forces exceeding those given in CS 22.143 at speeds up to V_T ;

(3) difficulty being experienced in regaining normal towing position after the sailplane has been displaced laterally or vertically; and

(4) any possibility, at the release, of the cable end or ends catching onto any part of the sailplane.

(b) Tests must be carried out with crosswind components not less than $0.2 V_{S0}$ or 15 km/h, whichever is the greater.

(c) Compliance with the following requirements must be shown:

(1) With the sailplane on tow in the normal towing position it must be displaced laterally relative to the towing aircraft by the use of rudder and aileron, to give an initial disturbance in bank of 30° . The pilot must then be able to regain the normal towing position without exceptional piloting skill.

(2) The sailplane must be flown in a high towing position (approximately 15° above the flight path of the towing aircraft), and also in a low towing position (below the wake of the towing aircraft). In each case the pilot must be able to regain the normal towing position without exceptional piloting skill.

(3) In conditions associated with the early stages of the aerotow, any pitching tendency of the sailplane must be immediately controllable, without exceptional piloting skill, under any combinations of allowable towing conditions. (See AMC 22.151(c)(3))

(d) A suitable range of cable lengths must be determined.

(e) Tests must be repeated for each location of the towing release mechanism and each configuration for which certification for aerotowing is requested.

CS 22.152 Winch-launching and auto-tow launching (See AMC 22.152)

(a) If the sailplane is equipped for winch-launching, or auto-tow launching, such launches must be demonstrated at speeds up to V_W , without:

(1) difficulty being experienced in maintaining the wings at zero bank angle when leaving the ground and in effecting a release;

(2) control forces exceeding those given in CS 22.143 or excessive control displacements;

(3) excessive pitching oscillation;

(4) push forces during the climb. If a trimming device is fitted, the position used during the climb must be stated.

(b) Tests must be carried out with crosswind components not less than $0.2 V_{S0}$ or 15 km/h, whichever is the greater.

(c) Tests must be made for each location and arrangement of the release mechanism and for each configuration for which certification for winch-launching or auto-tow launching is requested.

CS 22.153 Approach and landing

(a) With a crosswind component of not less than $0.2 V_{S0}$ or 15 km/h, whichever is the greater, it must be possible to perform normal approaches and landings until the sailplane comes to a stop, without exceptional piloting skill and without encountering any uncontrollable ground-looping tendency.

(b) After touchdown there must be no undue tendency to ground loop, pitching oscillation or nose over.

(c) The use of air brakes during the approach must not cause excessive variation of control force or control displacement nor affect the controllability of the sailplane, when it is brought into use at any allowable speed down to $1.2 V_{S1}$, where V_{S1} is appropriate to the configuration with air brakes retracted or extended, whichever gives the greater value.

CS 22.155 Elevator control force in manoeuvres

The elevator control forces during turns or when recovering from manoeuvres must be such that an increase in load factor causes an increase in control force. The minimum value of this force for a stabilized turn with a 45° bank at $1.4 V_{S1}$ must be 0.5 daN , with the controls trimmed to maintain the sailplane in equilibrium at $1.4 V_{S1}$ in steady straight flight with wing-flaps in the most critical position, air brakes and, where applicable, landing gear retracted.

TRIM

CS 22.161 Trim

(a) *General.* Each sailplane must meet the trim requirements of this paragraph after being trimmed and without further pressure upon, or movement of, the primary controls or their corresponding trim controls by the pilot.

(b) Lateral and directional trim

(1) *Lateral trim.* The sailplane must be capable of being so trimmed that there is no tendency for the sailplane when in straight flight at $1.4 V_{S1}$ with wing-flaps in all en-route positions, air brakes, and where applicable, landing gear retracted, to turn or bank, when the aileron control is released and the rudder control held fixed in the neutral position.

(2) *Directional trim.* The sailplane must be capable of being so trimmed that there is no tendency for the sailplane, when in straight flight at $1.4 V_{S1}$ with wing-flaps in all en-route positions, air brakes, and where applicable, landing gear retracted, to yaw when the rudder control is released and the aileron control held fixed in the neutral position.

(c) Longitudinal trim

(1) If the sailplane has no in-flight adjustable trimming device, the trim speed must be between $1.2 V_{S1}$ and $2.0 V_{S1}$ for all c.g. positions.

(2) If the sailplane has an in-flight adjustable trimming device, the following requirements must be met without further pressure upon or movement of the primary control or the corresponding trim control:

(i) the sailplane must maintain trim with wing-flaps in the landing position, the air brakes retracted and landing gear extended within the speed range between $1.2 V_{S1}$ and $2.0 V_{S1}$;

(ii) in towed flight the sailplane must maintain trim within the speed range between $1.4 V_{S1}$ and V_T ;

(iii) In the most adverse out-of-trim condition, the control force must be less than 20 daN between $1.1 V_{S1}$ and $1.5 V_{S1}$.

(3) For powered sailplanes, retraction and extension of the power-plant or propeller must not produce excessive trim changes.

(4) The powered sailplane, with the engine operating, must maintain longitudinal trim during;

(i) a climb with maximum continuous power at a speed V_Y with landing gear retracted and wing-flaps in the take-off position;

(ii) level flight at all speeds between V_Y and $0.9 V_H$, with the landing gear retracted and wing-flaps in positions appropriate to each speed.

STABILITY**CS 22.171 General**

The sailplane must meet the conditions of CS 22.173 through CS 22.181 inclusive. In addition the sailplane must show suitable stability and control 'feel' in any condition normally encountered in service.

CS 22.173 Static longitudinal stability

(a) Under the conditions and throughout the speed range specified in CS 22.175:

(1) The slope of the curve, stick force versus speed, must be positive and have a value such that any significant speed change will cause a variation in stick force plainly perceptible to the pilot.

(2) The slope of the curve, stick displacement versus speed, must not be negative, except that a negative slope may be acceptable provided that it can be demonstrated that there is no difficulty in control. (See AMC 22.173 (a))

(b) The air speed must return to within $\pm 15\%$ or ± 15 km/h of the original trimmed speed, whichever is the greater when the control force is slowly released at any trimmable speed up to V_{NE} and where applicable V_{NE} and down to the appropriate minimum speed for steady unstalled flight. In addition, for a powered sailplane with the engine running, this requirement must be met at all allowable power settings. (See AMC 22.173 (b))

CS 22.175 Demonstration of static longitudinal stability
(See AMC 22.175)

The stick force/speed curve must have a stable slope in the following conditions:

(a) *Cruising configuration:*

(1) at all speeds between $1.1 V_{S1}$ and V_{NE} ;

(2) wing-flaps in the position for cruising and for circling flight;

(3) landing gear retracted;

(4) sailplane trimmed at $1.4 V_{S1}$ and $2 V_{S1}$ (if fitted with a trimming device); and

(5) air brakes retracted.

(b) *Approach:*

(1) at all speeds between $1.1 V_{S1}$ and V_{FE} ;

(2) wing-flaps in the landing position;

(3) landing gear extended;

(4) sailplane trimmed at $1.4 V_{S1}$ (if fitted with a trimming device); and

(5) air brakes both retracted and extended.

(c) *Climb for powered sailplane:*

- (1) at all speeds between $0.85 V_Y$ or $1.05 V_{S1}$, whichever is higher, and $1.15 V_Y$.
- (2) landing gear retracted;
- (3) wing-flaps in the position for climb;
- (4) maximum weight;
- (5) maximum continuous power; and
- (6) sailplane trimmed at V_Y (if fitted with a trimming device).

(d) *Cruise for powered sailplane:*

- (1) at all speeds between $1.3 V_{S1}$ and V_{NE} ;
 - (2) landing gear retracted;
 - (3) wing-flaps retracted or, in the case of flaps approved for use in en-route flying, in all appropriate positions;
 - (4) maximum weight,
 - (5) power for level flight at $0.9 V_H$;
- and
- (6) sailplane trimmed for level flight (if fitted with a trimming device).

(e) *Approach for powered sailplane:*

- (1) at all speeds between $1.1 V_{S1}$ and V_{FE} ;
- (2) wing-flaps in the landing position;
- (3) landing gear extended;
- (4) sailplane trimmed at $1.5 V_{S1}$ (if fitted with a trimming device);
- (5) air brakes both retracted and extended;
- (6) engine idling (throttle closed); and
- (7) propeller in take-off position.

CS 22.177 Lateral and directional stability

(a) With the sailplane in straight steady flight, and when the aileron and rudder controls are gradually applied in opposite direction, any increase in sideslip angle must correspond to an increased deflection of the lateral control. This behaviour need not follow a linear law.

(b) In a sideslip any control force reversal must not be such as to require exceptional piloting skill to control the sailplane.

CS 22.181 Dynamic stability

Any short period oscillations occurring between the stalling speed and V_{DF} , must be heavily damped with the primary controls:

- (a) Free.
- (b) Fixed.

In the case of a powered sailplane this requirement must be met with the engine running at all allowable powers.

STALLS

CS 22.201 Wings level stall

(a) Stall demonstrations must be conducted by reducing the speed by approximately 2 km/h per second until either a stall results as evidenced by a downward pitching motion or rolling motion not immediately controllable or until the longitudinal control reaches the stop. It must be possible to produce and correct roll and yaw by unreversed use of the controls until the stall occurs.

(b) It must be possible to prevent more than 30° of roll by normal use of the controls during recovery. There must be no uncontrollable tendency of the sailplane to spin.

(c) Stalling behaviour must not be unduly sensitive to sideslip. (See AMC 22.201 (c))

(d) The loss of altitude from the beginning of the stall until regaining level flight by applying normal procedures and the maximum pitch attitude below the horizon must be determined. (See AMC 22.201 (d))

(e) With the sailplane in straight flight at $1.2 V_{S1}$ in the configuration appropriate to winch-launching by pulling rapidly on the control stick, a pitch attitude approximately 30° above the horizon must be achieved and the resulting stall must not be severe and such as to make prompt recovery difficult.

(f) Compliance with the requirements of sub-paragraphs (a) through (d) and (g) of this paragraph must be shown under the following conditions:

- (1) wing-flaps in any position;
- (2) air brakes retracted and extended;
- (3) landing gear retracted and extended;

(4) sailplane trimmed to $1.5 V_{S1}$ (if fitted with a trimmer);

(5) additionally, for powered sailplanes:-

(i) cowl flaps in appropriate configuration;

(ii) power:

– engine idling, and

– 90% of maximum continuous power;

(iii) propeller in take-off position

(g) For sailplanes equipped to carry water ballast, it must be shown that it is possible to regain level flight without encountering uncontrollable rolling or spinning tendencies in the stall demonstration of sub-paragraph (a) of this paragraph with the asymmetry that may result from any single malfunction of the system.

CS 22.203 Turning flight stalls

(a) When stalled during a co-ordinated 45° banked turn, it must be possible to regain normal level flight without encountering uncontrollable rolling or spinning tendencies. Compliance with this requirement must be shown under the conditions of CS 22.201(f) that result in the most critical stall behaviour of the sailplane. In any case the landing configuration, with airbrakes retracted and extended, must be investigated.

(b) The loss of altitude from beginning of the stall until regaining level flight by applying normal procedures must be determined.

CS 22.207 Stall warning

(a) Except as provided by 22.207(d), there must be a clear and distinctive stall warning with air brakes, wing-flaps and landing gear in any normal position, both in straight and in turning flight. In the case of a powered sailplane compliance with this requirement must also be shown with the engine running in the conditions prescribed in CS 22.201(f)(5).

(b) The stall warning may be furnished either through the inherent aerodynamic qualities of the sailplane (e.g. buffeting) or by a device that will give clearly distinguishable indications. (See AMC 22.207(b))

(c) The stall warning must begin:

(1) at a speed between $1.05 V_{S1}$ and

$1.1 V_{S1}$, or

(2) between 2 and 5 seconds before the stall occurs when longitudinal control is moved at a pace corresponding to approximately 2 km/h per second rate of reduction of speed

and must continue until the stall occurs.

(d) Compliance with 22.207(a) through (c) is not required for a sailplane, a self-launching powered sailplane with the engine stopped, or a self-sustaining powered sailplane with the engine stopped or running if the following are met with air brakes, wing-flaps and landing gear in any normal position:

(1) recovery from a stall is prompt in both straight and turning flight;

(2) when a stall occurs from straight flight:

(i) it is possible to produce and correct roll by using the ailerons, the rudder being held neutral; and

(ii) no appreciable wing-dropping occurs when both ailerons and rudder are held natural;

(3) when a stall occurs in a co-ordinated 45° banked turn, any subsequent rolling or yawing motion is not rapid and is readily controllable.

SPINNING

CS 22.221 General

(a) Compliance with the following requirements must be shown in all configurations and, for a powered sailplane, with the engine idling.

For sailplanes equipped to carry water ballast, the demonstrations of sub-paragraphs (b) to (g) must also be made for the most critical water ballast asymmetry that might occur due to any single malfunction or due to lateral accelerations during a spin.

(b) The sailplane must be able to recover from spins of at least five turns or such lesser number at which the spin changes into a spiral dive, by applying the controls in a manner normal for recovery and without exceeding either the limiting air-speed nor the limiting positive manoeuvring load factor for the sailplane. Tests

must be conducted with wing-flaps and air-brakes neutral (see AMC 22.335) and with:

- (1) controls held in the position normal for spins;
- (2) ailerons and rudder used in opposite directions;
- (3) ailerons applied in the direction of rotation.

In addition and where applicable, tests must be conducted in critical combinations of air-brake extension, wing-flap deflection, water-ballast including trim water-ballast and with the powerplant extended or retracted.

For wing-flap positions for which a V_{FE} limitation is established, the flap position may be adjusted during recovery after the auto-rotation has stopped. (See AMC 22.221 (b))

(c) A sailplane, in the configurations certificated for intentional spinning, must be able to recover from any point in a spin as defined in CS 22.221(b) in not more than one additional turn. In those configurations not approved for intentional spinning, sub-paragraph (d) must be applied. (See AMC 22.221 (c), (d), (e) and (f))

(d) A sailplane in the configurations not certificated for intentional spinning, must still be able to recover from a spin as defined in CS 22.221(b) in not more than one and a half additional turns. (See AMC 22.221 (c), (d), (e) and (f))

(e) In addition, any sailplane must be able to recover from a one turn spin in any configuration in not more than one additional turn. (See AMC 22.221 (c), (d), (e) and (f))

(f) The loss of altitude from the point at which recovery is initiated to the point at which horizontal flight is first regained must be determined in all of the above mentioned cases. (See AMC 22.221 (c), (d), (e) and (f))

(g) It must be impossible to obtain uncontrollable spins with any use of the controls.

CS 22.223 Spiral dive characteristics

If there is any tendency for the spin to turn into a spiral dive the stage at which this tendency occurs, must be determined. It must be possible to recover from the condition without exceeding either the limiting air speed or the limiting positive manoeuvring factor for the sailplane.

Compliance with this requirement must be shown without the use of air brakes.

GROUND HANDLING CHARACTERISTICS

CS 22.233 Directional stability and control

(a) With cross-wind components not less than $0.2 V_{S0}$ or 15 km/h, whichever is the greater, there must be no uncontrollable ground-loop tendency at any speed at which the powered sailplane may be expected to be operated on the ground.

(b) The powered sailplane must have adequate directional control during taxiing.

MISCELLANEOUS FLIGHT REQUIREMENTS

CS 22.251 Vibration and buffeting

Each part of the sailplane must be free from excessive vibration at all speeds up to at least V_{DF} . In addition, there must be no buffeting, in any normal flight condition including the use of air brakes, severe enough to interfere with the satisfactory control of the sailplane, cause excessive fatigue to the crew, or result in structural damage. Stall warning buffeting within these limits is allowable. In the case of a powered sailplane this requirement must be met with the engine running at all allowable powers.

CS 22.255 Aerobatic manoeuvres

(a) Each Aerobatic and Utility Category sailplane must be able to perform safely the aerobatic manoeuvres for which certification is requested. (See AMC 22.255 (a))

(b) It must be shown that aerobatic manoeuvres can be carried out with adequate margins between the speeds and accelerations attained therein and the proof strength and design speed of the sailplane.

(c) When determining the flight characteristics, account must be taken of the possibility of exceeding the recommended entry speeds for the manoeuvres and errors which are likely to be made by the pilot while being trained for aerobatic manoeuvres.

(d) During the flight tests it is not permitted to use any means (e.g. air brakes, wing-flaps) to restrict the speed in aerobatic manoeuvres.

(e) The recommended entry speed and where appropriate, the maximum acceleration must be determined for each manoeuvre approved.

Subpart C – Structure**GENERAL****CS 22.301 Loads**

(a) Strength requirements are specified in terms of limit loads (the maximum loads to be expected in service) and ultimate loads (limit loads multiplied by prescribed factors of safety). Unless otherwise provided, prescribed loads are limit loads.

(b) Unless otherwise provided, the air and ground loads must be placed in equilibrium with inertia forces, considering each item of mass in the sailplane. These loads must be distributed so as to represent actual conditions or a conservative approximation to them.

(c) If deflections under load would significantly change the distribution of external or internal loads, this redistribution must be taken into account.

CS 22.303 Factor of safety

Unless otherwise provided, a factor of safety of 1.5 must be used.

CS 22.305 Strength and deformation

(a) The structure must be able to support limit loads without permanent deformation. At any load up to limit loads, the deformation may not interfere with safe operation. This applies in particular to the control system.

(b) The structure must be able to support ultimate loads without failure for at least three seconds. However, when proof of strength is shown by dynamic tests simulating actual load conditions, the three second limit does not apply.

CS 22.307 Proof of structure

(a) Compliance with the strength and deformation requirements of CS 22.305 must be shown for each critical load condition. Structural analysis may be used only if the structure conforms to those for which experience has shown this method to be reliable. In other cases, substantiating load tests must be made. (See AMC 22.307(a))

(b) Certain parts of the structure must be tested as specified in Subpart D.

FLIGHT LOADS**CS 22.321 General**

(a) Flight load factors represent the ratio of the aerodynamic force component (acting normal to the flight path of the sailplane) to the weight of the sailplane. A positive flight load factor is one in which the aerodynamic force acts upward, with respect to the sailplane.

(b) Compliance with the flight load requirements of this Subpart must be shown:

(1) at each critical altitude within the range in which the sailplane may be expected to operate; and

(2) at each practicable combination of weight and disposable load. (See AMC 22.321 (b))

CS 22.331 Symmetrical flight conditions

(a) The appropriate balancing horizontal tail load must be accounted for in a rational or conservative manner when determining the wing loads and linear inertia loads corresponding to any of the symmetrical flight conditions specified in CS 22.333 through 22.345.

(b) The incremental horizontal tail loads due to manoeuvring and gusts must be reacted by the angular inertia of the sailplane in a rational or conservative manner.

(c) In computing the loads arising in the prescribed conditions, the angle of attack is assumed to be changed suddenly without loss of flight speed until the prescribed load factor is attained. Angular accelerations may be disregarded.

(d) Aerodynamic data required for the establishment of the loading conditions must be verified by tests, calculations or by conservative estimation.

(1) In the absence of better information the maximum negative lift coefficient in the normal configuration may be taken as -0.8

(2) If the pitching moment coefficient C_{mo} is less than ± 0.025 , a coefficient of at least -0.025 must be used for the wing and horizontal tail.

CS 22.333 Flight envelope

(a) *General.* Compliance with the strength requirements of this Subpart must be shown at any combination of air speed and load factor on and within the boundaries of the flight envelopes specified by the manoeuvring and gust criteria of

sub-paragraphs (b) and (c) of this paragraph respectively.

(b) *Manoeuvring envelope.* Wing-flaps in the en-route setting, air brakes closed. (See Figure 1.)

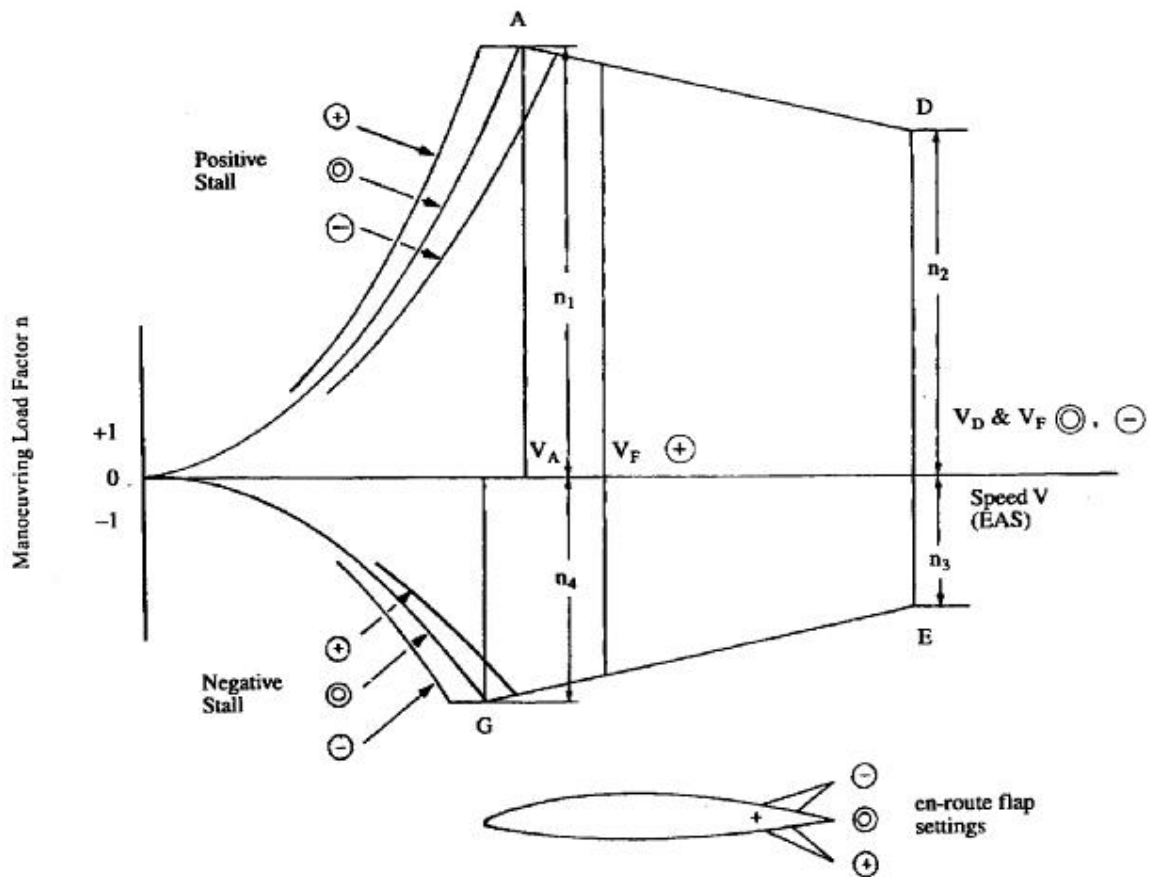

FIGURE 1 MANOEUVRING ENVELOPE

(c) *Gust envelope.* Wing-flaps in the en-route setting. (See Figure 2.)

(1) At the design gust speed V_B , the sailplane must be capable of withstanding positive (up) and negative (down) gusts of 15 m/s acting normal to the flight path.

(2) At the design maximum speed V_D , the sailplane must be capable of withstanding positive (up) and negative (down) gusts of 7.5 m/s acting normal to the flight path.

CS 22.335 Design air speeds
(See AMC 22.335)

The selected design air speeds are equivalent air speeds (EAS):

(a) *Design manoeuvring speed V_A*

$$V_A = V_{S1} \sqrt{n_1}$$

where:

V_{S1} = estimated stalling speed at design maximum weight with wing flaps neutral and air brakes retracted

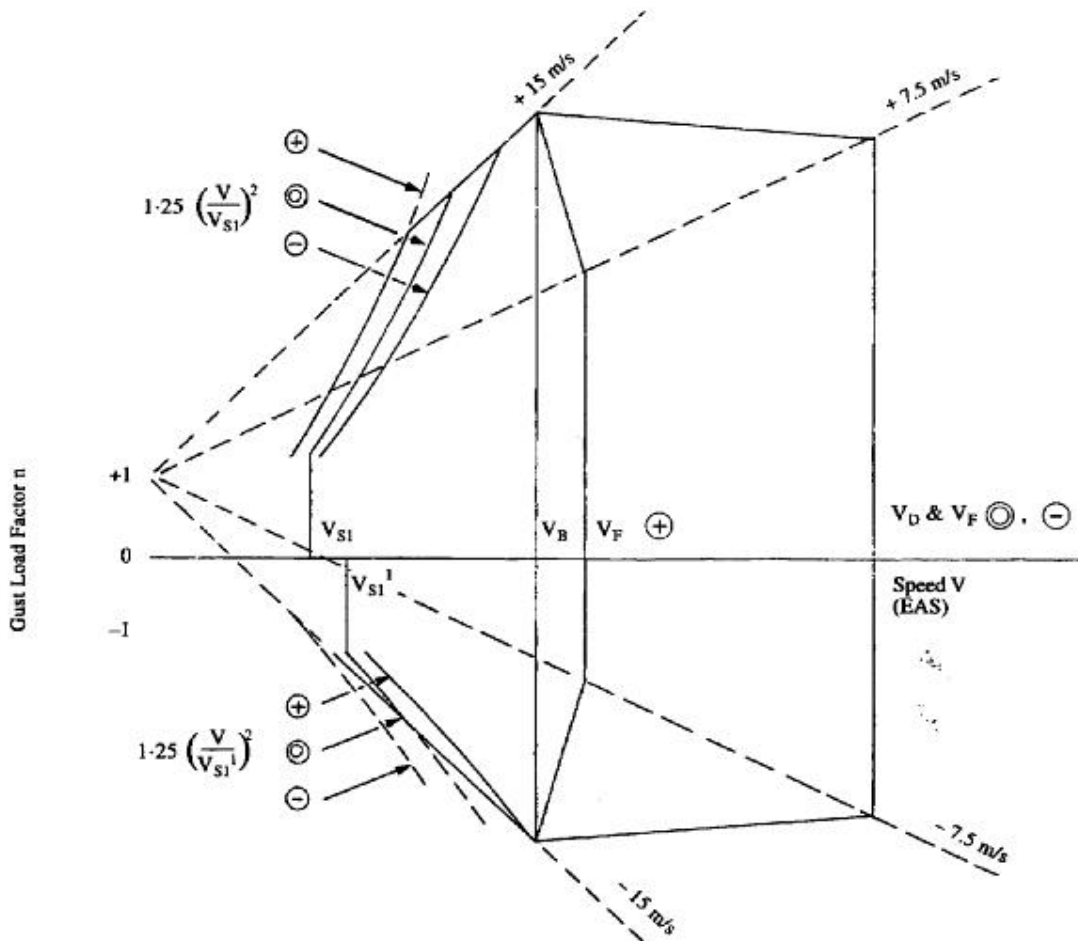

FIGURE 2 GUST ENVELOPE

(b) Design flap speed, V_F

(1) For each landing setting, V_F must not be less than the greater of :

(i) $1.4 V_{S1}$, where V_{S1} is the computed stalling speed with wing-flaps neutral at the maximum weight.

(ii) $2.0 V_{SF}$, where V_{SF} is the computed stalling speed with wing-flaps fully extended at the maximum weight.

(2) For each positive en-route setting, V_F must not be less than the greater of:

(i) $2.7 V_{S1}$, where V_{S1} is the computed stalling speed at design maximum weight with wing flaps in the particular positive en-route setting.

(ii) $1.05 V_A$, where V_A is determined in accordance with subparagraph (a) of this paragraph, i.e. for wing-flaps neutral.

(3) For all other settings, V_F must equal V_D .

(c) *Design Gust Speed* V_B . V_B must not be less than V_A .

(d) *Design Aerotow Speed* V_T . V_T must not be less than 125 km/h.

(e) *Design Winch-launching Speed* V_W . V_W must not be less than 110 km/h.

(f) *Design Maximum Speed* V_D . The design maximum speed may be chosen by the applicant but must not be lower than:

$$V_D = 18 \sqrt[3]{\left(\frac{W}{S}\right) \left(\frac{1}{C_{d_{min}}}\right)} \quad \text{(km/h) for sailplanes of Category U}$$

$$V_D = 3.5 \left(\frac{W}{S}\right) + 200 \quad \text{(km/h) for sailplanes of Category A}$$

where:

$\frac{W}{S}$ = Wing loading (daN/m²) at design maximum weight

$C_{d_{min}}$ = The lowest possible drag coefficient of the sailplane

For a powered sailplane, V_D must also not be lower than $1.35 V_H$.

CS 22.337 Limit manoeuvring load factors

The limit manoeuvring load factors on the V-n diagram (see Figure 1) must have at least the following values:

Category	U	A
n_1	+5.3	+7.0
n_2	+4.0	+7.0
n_3	-1.5	-5.0
n_4	-2.65	-5.0

CS 22.341 Gust load factors

(a) In the absence of a more rational analysis, the gust load factors must be computed as follows:

$$n = 1 \pm \left[\frac{\left(\frac{k}{2}\right) \rho_o U V a}{\left(\frac{mg}{S}\right)} \right]$$

where:

ρ_o = density of air at sea-level (kg/m³)

U = gust velocity (m/s)

V = equivalent air speed (m/s)

a = slope of wing lift curve per radian

m = mass of the sailplane (kg)

G = acceleration due to gravity (m/s²)

S = design wing area (m²)

k = gust alleviation factor calculated from the following formula:

$$k = \frac{0.88\mu}{5.3 + \mu} \quad \text{where:}$$

$$\mu = \frac{2 \frac{m}{S}}{\rho l m a} \quad \text{(non-dimensional sailplane mass ratio)}$$

where:

ρ = density of air (kg/m³) at the altitude considered

$l m$ = mean geometric chord of wing (m)

(b) The value of n calculated from the expression given above need not exceed:

$$n = 1.25 \left(\frac{V}{V_{SI}} \right)^2$$

CS 22.345 Loads with air brakes and wing-flaps extended

(a) *Loads with air brakes extended*

(1) The sailplane structure including airbrake system, must be capable of withstanding the most unfavourable combination of the following parameters:

Equivalent Air speed	V_D (EAS)
Air brakes	from the retracted to the fully extended position
Manoeuvring load factor	from -1.5 to 3.5

(2) The horizontal tail load is assumed to correspond to the static condition of equilibrium.

(3) In determining the spanwise load distribution, changes in this distribution due to the presence of the air brakes must be accounted for.

(b) *Load with wing-flaps extended.* If wing-flaps are installed, the sailplane must be assumed to be subjected to manoeuvres and gusts as follows:

(1) With wing-flaps in all landing settings, at speeds up to V_F :

(i) manoeuvring up to a positive limit load factor of 4.0;

(ii) positive and negative gusts of 7.5 m/s acting normal to the flight path.

(2) With wing-flap positions from the most positive en-route setting to the most negative setting, the manoeuvring conditions of CS 22.333(b) and the gust conditions of CS 22.333(c), except that the following need not be considered:

(i) speeds greater than the V_F appropriate to the wing-flap setting;

(ii) manoeuvring load factors corresponding to points above the line AD or below the line GE of Figure 1.

(c) *Speed limiting flaps.* If wing-flaps are to be used as a drag-increasing device for the purpose of speed limitation (air-brake) conditions specified in CS 22.345(a) must be met for all wing-flap positions.

(d) When an automatic wing-flap load limiting device is used, the sailplane must be designed for the critical combination of air speed and wing-flap position allowed by that device.

CS 22.347 Unsymmetrical flight conditions
(See AMC 22.347)

The sailplane is assumed to be subjected to the unsymmetrical flight conditions of CS 22.349 and CS 22.351. Unbalanced aerodynamic moments about the c.g. must be reacted in a rational or conservative manner, considering the principal masses furnishing the reacting inertia forces.

CS 22.349 Rolling conditions

The sailplane must be designed for the rolling loads resulting from the aileron deflections and speeds specified in CS 22.455 in combination with a load factor of at least two-thirds of the positive manoeuvring load factors prescribed in CS 22.337.

CS 22.351 Yawing conditions

The sailplane must be designed for yawing loads on the vertical tail surface specified in CS 22.441 and CS 22.443.

CS 22.361 Engine torque

(a) The engine mount and its supporting structure must be designed for the effects of:

(1) the limit torque corresponding to take-off power and propeller speed, acting simultaneously with 75% of the limit loads from flight condition A of CS 22.333(b);

(2) the limit torque corresponding to the maximum continuous power and propeller speed, acting simultaneously with the limit loads from flight condition A of CS 22.333(b).

(b) For reciprocating engines the limit torque to be accounted for in CS 22.361(a) is obtained by multiplying the mean torque by one of the following factors:

- (1) 1.33 for engines with 5 or more cylinders;
- (2) 2 for engines with 4 cylinders;
- (3) 3 for engines with 3 cylinders;
- (4) 4 for engines with 2 cylinders.

CS 22.363 Side load on engine mount

(a) The engine mount and its supporting structure must be designed for a limit load factor in a lateral direction, for the side load on the engine mount, of not less than one-third of the limit load factor for flight condition A ($1/3 n1$).

(b) The side load prescribed in (a) may be assumed to be independent of other flight conditions.

CS 22.371 Gyroscopic Loads

For powered sailplanes of airworthiness Category A, the engine mount and its supporting structure must be designed for gyroscopic loads resulting from maximum continuous r.p.m.

CS 22.375 Winglets

(a) When winglets are installed the sailplane must be designed for -

- (1) The side loads due to maximum sideslip angle of the winglet at V_A ;
- (2) Loads resulting from gusts acting perpendicularly to the surface of the winglet at V_B and V_D ;
- (3) Mutual interaction effects of winglets and wing on aerodynamic loads;
- (4) Hand forces on the winglets; and
- (5) Loads due to wingtip landing as specified in CS 22.501, if the winglet can touch the ground. (See AMC 22.375 (a))

(b) In the absence of more rational analysis the loads must be computed as follows:

- (1) The lift at the winglets due to sideslip at V_A -

$$L_{wm} = 1.25 C_{Lmax} S_w \frac{\rho_0}{2} V_A^2$$

where: C_{Lmax} = maximum lift coefficient of winglet profile

S_w = area of winglet

(2) The lift at the winglets due to lateral gust at V_B and V_D -

$$L_{wg} = a_w S_w \frac{\rho_0}{2} V U k$$

where: U = lateral gust velocity at the values as described in CS 22.333(c)

a_w = slope of winglet lift curve per radian

k = Gust alleviation factor as defined in CS 22.443(b)

The above-described load L_{wg} need not exceed the value

$$L_{Wmax} = 1.25 C_{Lmax} S_w \frac{\rho_0}{2} V_{max}^2$$

(3) Hand forces of 15 daN must be assumed to act at the tip of the winglet -

(i) In horizontal inboard and outboard direction parallel to the spanwise axis of the wing; and

(ii) In horizontal forward and backward direction parallel to the longitudinal axis of the fuselage.

In addition, the rigging loads as specified in CS 22.591 must be applied if the winglet plane is not normal to the plane of the wing.

CONTROL SURFACES AND SYSTEMS

CS 22.395 Control system loads

(a) Each flight control system, including stops, and its supporting structure must be designed for the loads corresponding to at least 125% of the computed hinge moments of the movable control surfaces in the conditions prescribed in CS 22.415 through CS 22.455. In

computing the hinge moments reliable aerodynamic data must be used. The effects of tabs must be taken into account. In no case must the loads in any part of the system be less than those resulting from the application of 60% of the pilot efforts specified in CS 22.397(a).

(b) Pilot forces used for design are assumed to act at the appropriate control grips or pads as they would in flight, and to be reacted at the attachments of the control system to the control surface horns.

CS 22.397 Loads resulting from limit pilot forces

(a) In addition to CS 22.395(a) the control systems for the direct control of the sailplane about its longitudinal, lateral, or yaw-axis (main control system) and other control systems affecting flight behaviour and supporting points must be designed to withstand as far as to the stops (these included) limit loads arising from the following pilot forces:

Control	Pilot force daN	Method of force application assuming single lever control systems
Elevator	35	Push and pull handgrip of control stick
Ailerons	20	Move handgrip of control stick sideways
Rudder	90	Apply forward pressure on one rudder pedal
Airbrakes Spoilers Wing-flaps	35	Push and pull handgrip of control lever
Towing cable release	35	Pull control handle

(b) The rudder control system must be designed to a load of 100 daN per pedal acting simultaneously on both pedals in forward direction.

CS 22.399 Dual control systems

Dual control systems must be designed for:

- (a) the pilots acting together in the same direction; and
- (b) the pilots acting in opposition,

each pilot applying 0.75 times the load specified in CS 22.397(a).

CS 22.405 Secondary control systems (See AMC 22.405)

Secondary control systems such as those for landing gear retraction or extension, trim control, etc., must be designed for supporting the maximum forces that a pilot is likely to apply to those controls.

CS 22.411 Control system stiffness and stretch

(a) The amount of movement available to the pilot of any aerodynamic control surface may not, in any condition of flight, be excessively reduced by elastic stretch of the control circuits.

If there are cables in the system and tension can be adjusted, the minimum value must be used for demonstrating compliance with all appropriate requirements. (See AMC 22.411 (a))

(b) For cable operated systems, the allowable rigging tension in the cables must be established, taking into consideration the variations in temperature (see CS 22.689) which may occur.

CS 22.415 Ground gust conditions

The control system from the control surfaces to the stops, or when installed, the arresting devices must be designed for limit loads corresponding to hinge moments calculated from the expression:

$$M_R = k l_R S_R q$$

where :

- M_R = limit hinge moment
- l_R = mean chord of control surface aft of hinge line
- S_R = area of control surface aft of hinge line
- q = dynamic pressure corresponding to an air speed of 100 km/h
- k = limit hinge moment factor due to ground gust, taken from the following table:

Control Surface	k	Remarks
Aileron	±0.75	Control column secured in mid-position
	±0.50	Ailerons at full travel + moment at the one, - moment at the other aileron
Elevator	±0.75	Elevator fully up (-) or fully down (+) or in the position in which it can be locked
Rudder	±0.75	Rudder at full travel right or left, or locked in neutral

P_o = horizontal tail balancing load acting on the horizontal tail before the appearance of the gust (N)

ρ_o = density of air at sea-level (kg/m³)

S_t = area of horizontal tail (m²)

a_h = slope of horizontal tail lift curve per radian

U = gust speed(m/s)

kH = gust factor. In the absence of a rational analysis the same value may be taken as for the wing.

V = speed of flight (m/s)

$\frac{d\varepsilon}{d\alpha}$ = rate of change of downwash angle with wing angle of attack

HORIZONTAL TAIL SURFACES

CS 22.421 Balancing loads

(a) A horizontal tail balancing load is the load necessary to maintain equilibrium in any specified flight condition with no pitching acceleration.

(b) The horizontal tail must be designed for the balancing loads occurring at any point of the limit manoeuvring envelope and in the air-brake and wing-flap positions as specified in CS 22.333 and CS 22.345.

CS 22.423 Manoeuvring loads
(See AMC 22.423)

The horizontal tail must be designed for the most severe loads likely to occur in pilot-induced pitching manoeuvres, at all speeds up to V_D .

CS 22.425 Gust loads

In the absence of a more rational analysis, the horizontal tail loads must be computed as follows:

$$P = P_o + \frac{\rho_o}{2} S_t a_h U kH V \left(1 - \frac{d\varepsilon}{d\alpha} \right)$$

where:

P = horizontal tail load (N)

CS 22.427 Unsymmetrical loads for powered sailplanes

The slipstream effect on fixed surfaces and on rudder loads must be accounted for if such loading is to be expected.

VERTICAL TAIL SURFACES

CS 22.441 Manoeuvring loads
(See AMC 22.441)

The vertical tail surfaces must be designed for manoeuvring loads imposed by the following conditions:

(a) At speed the greater of V_A and V_T , full deflection of the rudder.

(b) At speed V_D , one-third of full deflection of the rudder.

CS 22.443 Gust loads
(See AMC 22.443)

(a) Vertical tail surfaces must be designed to withstand lateral gusts to the values described in CS 22.333(c).

(b) In the absence of a more rational analysis, the gust load must be computed as follows:

$$P_f = a_v S_f \frac{\rho_o}{2} V U k$$

where:

P_f = gust load (N)

- a_v = slope of vertical tail lift curve per radian
 S_f = area of vertical tail (m^2)
 ρ_0 = density of air at sea-level (kg/m^3)
 V = speed of flight (m/s)
 U = gust speed (m/s)
 k = gust factor, should be taken as 1.2

SUPPLEMENTARY CONDITIONS FOR TAIL SURFACES

CS 22.447 Combined loads on tail surfaces

(a) The unsymmetrical distribution of the balancing load on the horizontal tail which arises in flight conditions A and D of the V-n envelope must be combined with the appropriate manoeuvring load on the vertical surface as specified in CS 22.441 acting in such a direction as to increase the rolling torque. (See AMC 22.447 (a))

(b) 75% for Category U and 100% for Category A of the loads according to CS 22.423 for the horizontal tail and CS 22.441 for the vertical tail must be assumed to be acting simultaneously.

CS 22.449 Additional loads applicable to V-tails

A sailplane with V-tail, must be designed for a gust acting perpendicularly with respect to one of the tail surfaces at speed V_B .

AILERONS

CS 22.455 Ailerons

The ailerons must be designed for control loads corresponding to the following conditions:

- (a) at speed the greater of V_A and V_T the full deflection of the aileron; and
 (b) at speed V_D , one-third of the full deflection of the aileron.

GROUND LOADS

CS 22.471 General

The limit ground loads specified in this Subpart are considered to be external loads and inertia forces that act upon a sailplane structure. In each specified ground load condition, the external reactions must be placed in equilibrium with the linear and angular inertia forces in a rational or conservative manner.

CS 22.473 Ground load conditions and assumptions

(a) The ground load requirements of this Subpart, must be complied with at the design maximum weight.

(b) The selected limit vertical inertia load factor at the c.g. of the sailplane for the ground load conditions prescribed in this Subpart

(i) may not be less than that which would be obtained when landing with a descent velocity of 1.77 m/s.

(ii) may not be less than 3.

(c) Wing lift balancing the weight of the sailplane may be assumed to exist throughout the landing impact and to act through the c.g. The ground reaction load factor may be equal to the inertia load factor minus one.

CS 22.477 Landing gear Arrangement (See AMC 22.447)

CS 22.479 through CS 22.499 apply to sailplanes with conventional arrangements of landing gear. For unconventional types it may be necessary to investigate additional landing conditions depending on the arrangement and design of the landing gear units.

CS 22.479 Level landing condition

(a) For a level landing, the sailplane is assumed to be in the following attitudes:

(1) For sailplanes with a tail skid and/or wheel, a normal level flight attitude.

(2) For sailplanes with nose wheels, attitudes in which –

(i) The nose and main wheels contact the ground simultaneously; and

(ii) The main wheels contact the ground and the nose wheel is just clear of the ground.

(b) The main gear vertical load component P_{VM} must be determined to the conditions in CS 22.725.

(c) The main gear vertical load component P_{VM} must be combined with a rearward acting horizontal component P_H so that the resultant load acts at an angle at 30° with the vertical.

(d) For sailplanes with nose wheels the vertical load component P_{VN} on the nose wheel in the attitude of sub-paragraph (a) (2) (i) of this paragraph must be computed as follows and must be combined with a rearward acting horizontal component according to sub-paragraph (c) of this paragraph taking into account CS 22.725(a):

$$P_{VN} = 0.8 m g$$

where:

m = mass of the sailplane (kg)
 g = acceleration of gravity (m/s^2).

CS 22.481 Tail-down landing conditions (See AMC 22.481)

For design of tail skid and affected structure and empennage including balancing weight attachment, the tail skid load in a tail down landing (main landing gear free from ground) must be calculated as follows:

$$P = 4 mg \left(\frac{i_y^2}{i_y^2 + L^2} \right)$$

where:

P = tail skid load (N)
 m = mass of the sailplane (kg)
 g = acceleration of gravity (m/s^2)
 i_y = radius of gyration of the sailplane (m)
 L = distance between tail skid and sailplane c.g. (m)

CS 22.483 One-wheel landing condition

If the two wheels of a main landing gear arrangement are laterally separated (see AMC 22.477, (1)) the conditions under CS 22.479 (a)(2), (b) and (c) must be applied also to each wheel separately taking into account limiting

effects of bank. In the absence of a more rational analysis the limit kinetic energy must be computed as follows:

$$A = \frac{1}{2} m_{red} V_v^2$$

where:

$$m_{red} = m \frac{1}{1 + \frac{a^2}{i_x^2}}$$

V_v = rate of descent

m = mass of the sailplane (kg)

a = half the track (m)

i_x = radius of gyration of the sailplane (m)

CS 22.485 Side load conditions

A side load acting on one side of the main landing gear (both from right and left) normal to the plane of symmetry at the centre of the contact area of the tyre or skid with the ground, must be assumed. The applied load is equal to $0.3 P_v$ and must be combined with a vertical load of $0.5 P_v$ where P_v is the vertical load determined in accordance with CS 22.473.

CS 22.497 Tail skid impact

(a) Except as provided in (b), if the c.g. of the unloaded sailplane – in side view – is situated behind the ground contact area of the main landing gear, the rear portion of the fuselage, the tail skid and the empennage must be designed to withstand the loads arising when the tail landing gear is raised to its highest possible position, consistent with the main wheel remaining on the ground, and is then released and allowed to fall freely.

(b) If the c.g. in all loading conditions is situated behind the ground contact area of the main landing gear (a) need not be applied.

CS 22.499 Supplementary conditions for nose wheels

In determining the ground loads on the nose wheel and affected supporting structures, and assuming that the shock absorber and tyre are in their static positions, the following conditions must be met:

(a) For forward loads, the limit force components at the axle must be:

(1) A vertical component of 2.25 times the static load on the wheel; and

(2) A forward component of 0.4 times the vertical component.

(b) For side loads, the limit force components at ground contact must be:

(1) A vertical component of 2.25 times the static load on the wheel; and

(2) A side component of 0.7 times the vertical component.

CS 22.501 Wing-tip landing

There must be means to ensure that ground loads acting at the wing tips are adequately resisted. A limit load $T = 40 \text{ daN}$ must be assumed to act rearward at the point of contact of one wing-tip with the ground, in a direction parallel to the longitudinal axis of the sailplane, the yawing moment so generated must be balanced by side load R at the tail skid/wheel or nose skid/wheel (see Figure 4).

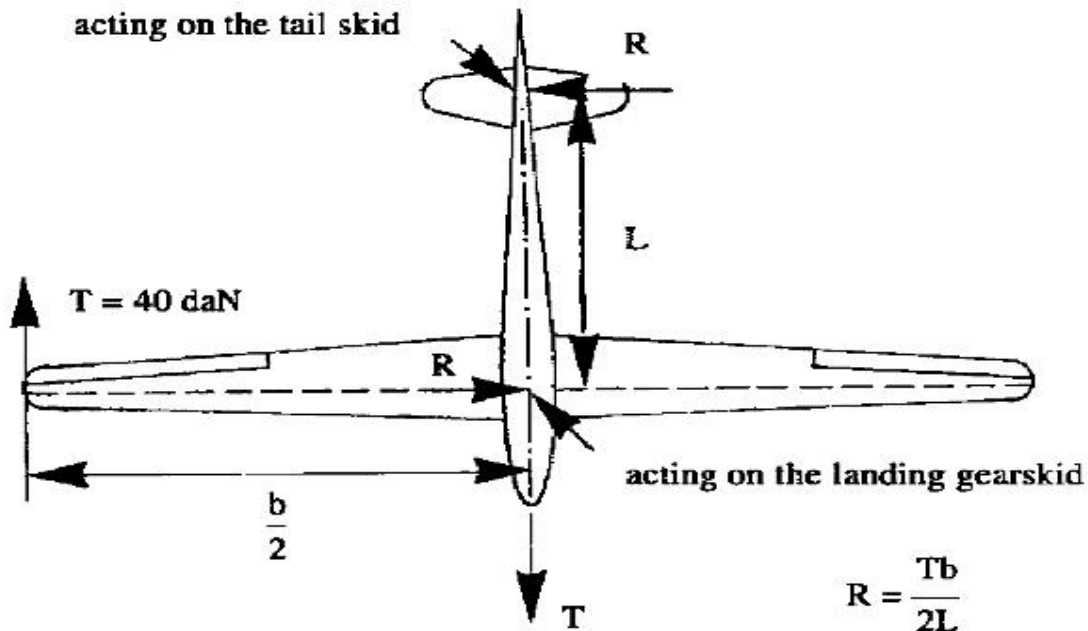

FIGURE 4 WING-TIP LANDING

EMERGENCY LANDING CONDITIONS

CS 22.561 General
(See AMC 22.561)

(a) The sailplane although it may be damaged in emergency landing conditions must be designed as prescribed in this paragraph to protect each occupant under those conditions.

(b) The structure must be designed to give each occupant every reasonable chance of escaping serious injury in a crash landing when

proper use is made of belts and harnesses provided for in the design, in the following conditions:

(1) The occupant experiences, separately, ultimate inertia forces corresponding to the accelerations shown in the following:

Upward	7.5 g
Forward	15.0 g
Sideward	6.0 g
Downward	9.0 g

(2) An ultimate load of 9 times the weight of the sailplane acting rearwards and upwards at an angle of 45° to the longitudinal axis of the sailplane and sideward at an angle of 5° acts on the forward portion of the fuselage at a suitable point not behind the pedals. (See AMC 22.561(b)(2))

(c) Each sailplane with a retractable landing gear must be designed to protect each occupant in a landing with wheel(s) retracted under the following conditions:

(1) a downward ultimate inertia force corresponding to an acceleration of 3 g;

(2) a coefficient of friction of 0.5 at the ground.

(d) Except as provided in CS 22.787, the supporting structure must be designed to restrain, under loads up to those specified in sub-paragraph (b)(1) of this paragraph each item of mass that could injure an occupant if it came loose in a crash landing.

(e) For a powered sailplane with the engine located behind and above the pilot's seat, an ultimate inertia load of 15 g in the forward direction must be assumed.

[Amdt 22/1]

TOWING AND LAUNCHING LOADS

CS 22.581 Aerotowing

(a) The sailplane must be initially assumed to be in stabilized level flight at speed V_T with a cable load acting at the launching hook in the following directions:

(1) horizontally forwards;

(2) in plane of symmetry forwards and upwards at an angle of 20° with the horizontal;

(3) in plane of symmetry forwards and downwards at an angle of 40° with the horizontal; and

(4) horizontally forwards and sideways at an angle of 30° with the plane of symmetry.

(b) With the sailplane initially assumed to be subjected to the same conditions as specified in CS 22.581 (a), the cable load due to surging suddenly increases to Q_{nom} , assuming the use of a textile rope.

(1) The resulting cable load increment must be balanced by linear and rotational inertia forces. These additional loads must be superimposed on those arising from the conditions of CS 22.581(a).

(2) Q_{nom} is the rated ultimate strength of the towing cable (or weak link if employed). For the purpose of these requirements it must be assumed to be not less than 1.3 times the sailplane maximum weight and not less than 500 daN.

CS 22.583 Winch-launching

(a) The sailplane must be initially assumed to be in level flight at speed V_W with a cable load acting at the launching hook in a forward and downward direction at an angle ranging from 0° to 75° with the horizontal.

(b) The cable load must be determined as the lesser of the following two values:

(1) 1.2 Q_{nom} as defined in CS 22.581(b), or

(2) the loads at which equilibrium is achieved, with either:

(i) the elevator fully deflected in upward direction, or

(ii) the wing at its maximum lift.

A horizontal inertia force may be assumed to complete the equilibrium of horizontal forces.

(c) In the conditions of CS 22.583(a), a sudden increase of the cable load to the value of 1.2 Q_{nom} as defined in CS 22.581(b), is assumed. The resulting incremental loads must be balanced by linear and rotational inertia forces.

CS 22.585 Strength of launching hook attachment

(a) The launching hook attachment must be designed to carry a limit load of $1.5 Q_{nom}$, as defined in CS 22.581(b), acting in the directions specified in CS 22.581 and CS 22.583.

(b) The launching hook attachment must be designed to carry a limit load equal to the maximum weight of the sailplane, acting at an angle of 90° to the plane of symmetry.

factors to be expected from the established flight and ground loads.

OTHER LOADS**CS 22.591 Rigging and de-rigging loads**

A rigging limit load of plus and minus twice the wing-tip reaction, determined when either a semi-span wing is simply supported at root and tip or when the complete wing is simply supported at the tips, where this would be representative of the rigging procedure, must be assumed to be applied at the wing tip and reacted by the wing when supported by a reaction and couple at the wing root.

CS 22.593 Hand forces at the horizontal tail surfaces

A limit hand force of 3% of the design maximum weight of the sailplane but not less than 15 daN must be assumed to act on either tip of the horizontal tail surface:

- (a) in the vertical direction;
- (b) in the horizontal direction, parallel to the longitudinal axis.

CS 22.595 Load on the attachment point of the parachute ripcord

The attachment point for the parachute ripcord (if provided) must be designed for a limit load of 300 daN acting in all possible directions.

CS 22.597 Loads from single masses

The attachment means for all single masses, which are part of the equipment of the sailplane, must be designed to withstand loads corresponding to the maximum design load

Subpart D — Design and Construction

CS 22.601 General

The suitability of each questionable design detail and part having an important bearing on safety in operations must be established by test.

CS 22.603 Materials

The suitability and durability of materials used for parts, the failure of which could adversely affect safety, must –

(a) be established by experience or tests; and

(b) meet approved specifications that ensure their having the strength and other properties assumed in the design data.

CS 22.605 Fabrication methods

The methods of fabrication used must produce consistently sound structures. If a fabrication process (such as glueing, spot welding, heat-treating, or processing of plastic materials) requires close control to reach this objective, the process must be performed under an approved process specification.

CS 22.607 Locking of connections

An approved means of locking must be provided on all connecting elements in the primary structure and in control and other mechanical systems which are essential to safe operation of the sailplane. In particular self-locking nuts may not be used in any bolt subject to rotation in operation, unless a non-friction locking device is used in addition to the self-locking device.

CS 22.609 Protection of structure

Each part of the structure must –

(a) be suitably protected against deterioration or loss of strength in service due to any cause, including –

- (1) weathering;
- (2) corrosion; and
- (3) abrasion; and

(b) have adequate provisions for ventilation and drainage.

CS 22.611 Accessibility (See AMC 22.611)

Means must be provided to allow:

(a) inspection of principal structural elements and control systems;

(b) replacement of parts normally requiring replacement; and

(c) adjustment and lubrication as necessary for continued airworthiness.

The means of inspection must be practicable for the inspection intervals established for the item during certification. This must be stated in the maintenance manual required under CS 22.1529.

CS 22.612 Provisions for rigging and de-rigging

The design of the sailplane must be such that during rigging and de-rigging by untrained persons, the probability of damage or permanent deformation, especially when this is not readily visible, is extremely remote. Incorrect assembly must be avoided by proper design provisions. It must be possible to inspect the sailplane easily for correct rigging.

CS 22.613 Material strength properties and design values

(a) Material strength properties must be based on enough tests to establish design values on a statistical basis.

(b) The design values must be chosen so that the probability of any structure being understrength because of material variations is extremely remote. (See AMC 22.613 (b))

(c) Where the temperature attained in an essential component or structure in normal operating conditions has a significant effect on strength, that effect must be taken into account. (See AMC 22.613 (c))

CS 22.619 Special factors

(a) The factor of safety prescribed in CS 22.303 must be multiplied by appropriate combinations of the special factors prescribed in CS 22.621 through CS 22.625, CS 22.657, CS 22.693 and CS 22.619(b). (See AMC 22.619 (a))

(b) For each part of the structure not covered by CS 22.621 through CS 22.625, CS 22.657 and CS 22.693 but whose strength is

- (1) uncertain;
- (2) likely to deteriorate in service before normal replacement; or
- (3) subject to appreciable variability because of uncertainties in manufacturing processes or inspection methods; the special factor must be chosen so that failure of the part due to inadequate strength is improbable.

CS 22.621 Casting factors

For castings the strength of which is substantiated by at least one static test and which are inspected by visual methods, a casting factor of 2.0 must be applied. This factor may be reduced to 1.25 providing the reduction is substantiated by tests on not less than three sample castings and if these and all production castings are subjected to an approved visual and radiographic inspection or an approved equivalent non-destructive inspection method.

CS 22.623 Bearing factors

(a) The factor of safety for bearings at bolted or pinned joints must be multiplied by a special factor of 2.0 to provide for:

- (1) relative motion in operation; and
- (2) joints with clearance (free fit) subject to pounding and/or vibration.

(b) For control surface hinges and control system joints, compliance with the factors prescribed in CS 22.657 and CS 22.693, respectively, meets sub-paragraph (a) of this paragraph.

CS 22.625 Fitting factors

For each fitting (a part or terminal used to join one structural member to another), the following apply:

(a) For each fitting whose strength is not proven by limit and ultimate load tests in which actual stress conditions are simulated in the fitting and surrounding structures, a fitting factor of at least 1.15 must be applied to each part of –

- (1) the fitting;
- (2) the means of attachment; and
- (3) the bearing on the joined members.

(b) No fitting factor need be used for joint designs based on comprehensive test data (such as continuous joints in metal plating, welded joints, and scarf joints in wood).

(c) For each integral fitting, the part must be treated as a fitting up to the point at which the section properties become typical of the member.

(d) For each seat, safety belt, and harness, its attachment to the structure must be shown, by analysis, tests, or both, to be able to withstand the inertia forces prescribed in CS 22.561 multiplied by a fitting factor of 1.33.

(e) When using only two hinges at each control surface, or wing-flap, the safety factor for these hinges and the attached parts of the primary structure must be multiplied by a factor of 1.5.

CS 22.627 Fatigue strength

The structure must be designed, as far as practicable, to avoid points of stress concentration where variable stresses above the fatigue limit are likely to occur in normal service.

CS 22.629 Flutter

(a) The sailplane must be free from flutter, aerofoil divergence, and control reversal in each configuration and at each appropriate speed up to at least V_D . Sufficient damping must be available at any appropriate speed so that aeroelastic vibration dies away rapidly.

(b) Compliance with sub-paragraph (a) must be shown by:

(1) a ground vibration test which includes an analysis and an evaluation of the established vibration modes and frequencies for the purpose of recognising combinations critical for flutter, either by:

(i) an analytical method, which will determine any critical speed in the range up to $1.2 V_D$, or

(ii) any other approved method.

(2) systematic flight tests to induce flutter at speeds up to V_{DF} . These tests must show that a suitable margin of damping is available and that there is no rapid reduction of damping as V_{DF} is approached.

(3) flight tests to show that when approaching V_{DF} :

(i) control effectiveness around all three axes is not decreasing in an unusually rapid manner, and

(ii) no signs of approaching aerofoil divergence of wings, tailplane and fuselage result from the trend of the static stabilities and trim conditions.

CONTROL SURFACES

CS 22.655 Installation

(a) Movable control surfaces must be installed so that there is no interference between any surfaces or their bracings when one surface is held in any position and the others are operated through their full angular movement. This requirement must be met:

(1) under limit load (positive or negative) conditions for all control surfaces through their full angular range; and

(2) under limit load on the sailplane structure other than control surfaces.

(b) If an adjustable stabilizer is used, it must have stops that will limit its range of travel to that allowing safe flight and landing.

CS 22.657 Hinges

(a) Control surface hinges, except ball and roller bearing hinges, must have a factor of safety of not less than 6.67 with respect to the ultimate bearing strength of the softest material used as a bearing.

(b) For ball or roller bearing hinges, the approved rating of the bearing may not be exceeded.

(c) Hinges must have enough strength and rigidity for loads parallel to the hinge line.

CS 22.659 Mass balance

The supporting structure and the attachment of concentrated mass balance weights used on control surfaces must be designed for -

(a) 24g normal to the plane of the control surface;

(b) 12 g fore and aft; and

(c) 12 g parallel to the hinge line.

CONTROL SYSTEMS

CS 22.671 General

Each control must operate easily, smoothly, and positively enough to allow proper performance of its functions.

CS 22.675 Stops

(a) Each control system must have adjustable stops that positively limit the range of motion of each movable aerodynamic surface controlled by the system.

(b) Each stop must be located so that wear, slackness, or take-up adjustments will not adversely affect the control characteristics of the sailplane because of a change in the range of surface travel.

(c) Each stop must be able to withstand any loads corresponding to the design conditions for the control system.

CS 22.677 Trim system

(a) Proper precautions must be taken to prevent inadvertent, improper, or abrupt trim tab operation. There must be means near the trim control to indicate to the pilot the direction of trim control movement relative to sailplane motion. In addition, there must be means to indicate to the pilot the position of the trim device with respect to the range of adjustment. This means must be visible to the pilot and must be located and designed to prevent confusion.

(b) Tab controls must be irreversible unless the tab is properly balanced and has no unsafe flutter characteristics. Irreversible tab systems must have adequate rigidity and reliability in the portion of the system from the tab to the attachment of the irreversible unit to the sailplane structure.

CS 22.679 Control system locks

If there is a device to lock the control system on the ground, there must be means to -

(a) give unmistakable warning to the pilot when the lock is engaged; and

(b) prevent the lock from engaging in flight.

CS 22.683 Operation tests

It must be shown by functional tests that the system designed to the loads specified in CS 22.397 is free from:

- (a) jamming;
- (b) excessive friction; and
- (c) excessive deflection;

when operating the controls from the cockpit.

CS 22.685 Control system details

(a) Each detail of each control system must be designed and installed to prevent jamming, chafing, and interference from baggage, passengers, loose objects, or the freezing of moisture.

(b) There must be means in the cockpit to prevent the entry of foreign objects into places where they would jam the system.

(c) There must be means to prevent the slapping of cables or rods against other parts.

(d) Each element of the flight control system must have design features, or must be distinctively and permanently marked, to minimize the possibility of incorrect assembly that could result in malfunctioning of the control system. (See AMC 22.685 (d))

(e) In sailplanes certificated for aerobatic manoeuvres, where necessary the rudder pedals must be provided with loops to prevent the feet from slipping off the pedals.

CS 22.687 Spring devices

The reliability of any spring device used in the control system must be established by tests simulating service conditions unless failure of the spring will not cause flutter or unsafe flight characteristics.

CS 22.689 Cable systems

(a) Each cable, cable fitting, turnbuckle, splice, and pulley used must meet approved specifications. In addition –

- (1) no cable smaller than 3 mm diameter may be used in primary control systems;
- (2) each cable system must be designed so that there will be no hazardous change in cable tension throughout the range

of travel under operating conditions and temperature variations; and

(3) there must be means for visual inspection at each fairlead, pulley, terminal, and turnbuckle. The need for this requirement may be waived when it can be shown that airworthiness will not be affected within the service life of these components.

(b) Each kind and size of pulley must correspond to the cable with which it is used. Each pulley must have closely fitted guards to prevent the cables from being misplaced or fouled, even when slack. Each pulley must lie in the plane passing through the cable so that the cable does not rub against the pulley flange. (See AMC 22.689 (b))

(c) Fairleads must be installed so that they do not cause a change in cable direction of more than 3°, except where tests or experience indicate that a higher value would be satisfactory. The radius of curvature of fairleads must not be smaller than the radius of a pulley for the same cable.

(d) Turnbuckles must be attached to parts having angular motion in a manner that will positively prevent binding throughout the range of travel.

(e) Tab control cables are not part of the primary control system and may be less than 3 mm diameter in sailplanes that are safely controllable with the tabs in the most adverse positions.

CS 22.693 Joints

Control system joints (in push-pull systems) that are subject to angular motion, except those in ball and roller bearing systems, must have a special factor of safety of not less than 3.33 with respect to the ultimate bearing strength of the softest material used as a bearing. This factor may be reduced to 2.0 for joints in cable control systems. For ball or roller bearings, the approved ratings may not be exceeded.

CS 22.697 Wing-flap and air-brake controls

(a) Each wing-flap control must be designed so that, when the wing-flap has been placed in any position upon which compliance with the performance requirements of this Part is

based, the wing-flap will not move from that position except when:

(1) the control is adjusted; or

(2) the wing-flap is moved by the automatic operation of a wing-flap load limiting device; or

(3) movement other than in accordance with (1) or (2) is demonstrated not to be hazardous.

(b) Each wing-flap and air brake must be designed to prevent inadvertent extension or movement. The pilot forces and the rate of movement at any approved flight speed must not be such as to impair the operating safety of the sailplane.

(c) The air brake or other drag increasing device necessary to show compliance with CS 22.73 and/or CS 22.75 must comply with the following:

(1) Where the device is divided into several parts, all parts must be operated by a single control.

(2) It must be possible to extend the device at any speed up to $1.05 V_{NE}$ and to retract the device at any speed up to V_T , but not less than $1.8 V_{S1}$, with a hand force not exceeding 20 daN.

(3) The time required for extension as well as retraction of the device may not exceed 2 seconds.

CS 22.699 Wing-flap position indicator

There must be means near the wing-flap control to indicate to the pilot the position of the wing-flaps during and after operation.

CS 22.701 Wing-flap interconnection

The motion of wing-flaps on opposite sides of the plane of symmetry must be synchronized by a mechanical interconnection unless the sailplane has safe flight characteristics with the wing-flaps retracted on one side and extended on the other.

CS 22.711 Release mechanisms

(a) Release mechanisms to be used for winch-launching must be so designed and installed as to release the towing cable automatically (i.e. to back-release) if the

sailplane overruns the cable while it is carrying any appreciable load.

(b) The release mechanisms must be approved.

(c) It must be extremely improbable for bolts or other projections on the release mechanism itself or the structure surrounding the mechanism, including the landing gear, to foul the towing cable or its parachute.

(d) It must be shown that the release force will not exceed that prescribed in CS 22.143(c) when a cable load Q_{nom} is applied in any direction (see CS 22.583), and that the release mechanism functions properly under any operating condition.

(e) The range of travel of the release lever in the cockpit, including free travel, must not exceed 120 mm.

(f) The release lever in the cockpit must be arranged and designed so that the pilot force as defined in CS 22.143(c) can be easily applied.

(g) A visual inspection of the release mechanism must be easily possible.

CS 22.713 Launching hook

Depending on the launching method(s) for which certification is requested, the sailplane must be fitted with one or more launching hooks complying with the following:

(a) Each hook to be used for aerotow launching must be –

(1) Designed to minimise the possibility of inadvertent release, and;

(2) Installed to minimise the possibility of dangerous upsets during aerotowing (see CS 22.151(a)(3)) and to produce a nose-down pitching moment on the sailplane under the conditions of CS 22.581(a)(3), but with an angle of not more than 25° .

(b) Each hook to be used for winch and/or auto-tow launching must be equipped with a release device which is automatically activated when the sailplane overflies the towing winch or auto-tow vehicle.

(c) The release control system must be designed to actuate the release mechanism of each launching hook at the same time, where more than one launching hook is fitted.

LANDING GEAR

CS 22.721 General

(a) The sailplane must be so designed that it can land on unprepared soft ground without endangering its occupants.

(b) Each sailplane fitted with retractable landing gear must be designed and constructed so that normal landings with the landing gear retracted are possible.

(c) The design of wheels, skids and tail skid and their installation must be such as to minimize the possibility of fouling by the towing cable.

(d) If the main landing gear consists only of one or more wheels, the sailplane must be equipped with mechanical braking devices, such as wheel brakes.

(e) A shock-absorbing element must be fitted to the tail skid.

CS 22.723 Shock absorption test (See AMC 22.723)

The proof of sufficient shock absorption capacity must be determined by test. The landing gear must be able to absorb 1.44 times the energy described in CS 22.473 without failure although it may yield during the test.

CS 22.725 Level landing

(a) The shock absorbing elements (including tyres) must be capable of absorbing the kinetic energy developed in a landing without being fully depressed.

(b) The value of kinetic energy must be determined under the assumption that the weight of the sailplane corresponds to the design maximum weight with a constant rate of descent equalling the value given in CS 22.473(b) and the wing lift balancing the weight of the sailplane.

(c) Under the assumption of (b) the c.g. acceleration must not exceed 4.5 g.

CS 22.729 Retracting mechanism

(a) Each landing gear retracting mechanism and its supporting structure must be designed for the maximum flight load factors occurring with the gear retracted.

(b) For retractable landing gears it must be shown that extension and retraction of the landing gear are possible without difficulty up to V_{LO} .

(c) A sailplane equipped with a non-manually operated landing gear must have an auxiliary means of extending the gear.

CS 22.731 Wheels and tyres

(a) Each landing gear main wheel must be approved.

(b) The maximum limit load rating of each wheel must equal or exceed the maximum radial limit load determined under the applicable ground load requirements. Each individual wheel of twin and tandem landing gears must be designed to support 70% of the maximum allowable weight.

COCKPIT DESIGN

CS 22.771 General

(a) The cockpit and its equipment must allow each pilot to perform his duties without unreasonable concentration or fatigue.

(b) A means must be provided to enable ballast provided in accordance with CS 22.31(c) to be stowed safely in the sailplane.

CS 22.773 Cockpit view

Each cockpit must be free from glare and reflections that could interfere with the pilot's vision, and designed so that:

(a) the pilot's vision is sufficiently extensive, clear and undistorted for safe operation; and

(b) each pilot is protected from the elements. Rain and icing may not unduly impair his view along the flight path in normal flight and during landing. (See AMC 22.773 (b))

CS 22.775 Windshields and windows

(a) Windshields and windows must be constructed of a material that will not result in serious injuries due to splintering. (See AMC 22.775 (a))

(b) Windshields and side windows of the canopy must have a luminous transmittance value of at least 70% and must not significantly alter the natural colours.

CS 22.777 Cockpit controls

(a) Each cockpit control must be located to provide convenient operation, and to prevent confusion and inadvertent operation. (See AMC 22.777 (a))

(b) The controls must be located and arranged so that the pilot, when strapped in his seat, has full and unrestricted movement of each control without interference from either his clothing (including winter clothing) or from the cockpit structure. The pilot must be able to operate all the controls necessary for the safe operation of the aeroplane from the seat designated to be used for solo flying.

(c) In sailplanes with dual controls it must be possible to operate the following secondary controls from each of the two pilots' seats –

- (1) release mechanism;
- (2) air brakes;
- (3) wing-flaps;
- (4) trim;
- (5) opening and jettisoning device of the canopy;
- (6) throttle lever.

(See AMC 22.777 (c))

(d) Controls must maintain any desired position without requiring constant attention by the pilot(s), and must not tend to creep under system loads or vibration. A means of adjusting the freedom of operation of the throttle control during flight to achieve this must be provided. Controls must have adequate strength to withstand the loads without failure or excessive deflection. (See AMC 22.777 (d))

CS 22.779 Motion and effect of cockpit controls

Cockpit controls must be designed so that they operate as follows:

Controls	Motion and effect
Aileron	right (clockwise)for right wing down
Elevator	rearward for nose up
Rudder	right pedal forward for nose right
Trim	corresponding to sense of motion of the controls
Air brakes	pull to extend
Wing-flaps	pull for wing-flaps down or extended
Towing cable release	pull to release
Canopy jettisoning	not prescribed, preferably pull to jettison
Throttle control	forward to increase power
Propeller pitch	forward to increase r.p.m.
Mixture	forward, or up for rich
Carburettor air heat or Alternate air	forward or upward for cold, or alternate air off

CS 22.780 Colour marking and arrangement of cockpit controls
(See AMC 22.780)

Cockpit controls must be marked and located as follows:

Control	Colour	Location
Towing cable release	yellow	for left hand operation.
Air brakes	blue	for left hand operation, or, in the case of a two-seat sailplane between the two pilot positions.
Trimmer (longitudinal trim)	green	preferably for left hand operation.
Canopy operating handle	white *	not prescribed.
Canopy jettison handle	red *.	not prescribed but must be within easy reach.
Other controls,	to be clearly marked but not yellow, red	

* If canopy opening and jettison are combined in one handle, the colour must be red.

CS 22.781 Cockpit control knob shape
(See AMC 22.781)

The towing cable release control must be so designed to be capable of operation by a gloved hand exerting the force specified in CS 22.143(c).

CS 22.785 Seats and safety harnesses

(a) Each seat and its supporting structure must be designed for an occupant weight in accordance with CS 22.25(a)(2) and for the maximum load factors corresponding to the specified flight and ground conditions including the emergency landing conditions prescribed in CS 22.561. Each seat and its supporting structure must also be designed to withstand the reaction to the load specified in CS 22.397(b).

(b) Seats including cushions may not deform to such an extent that the pilot when subjected to loads corresponding to CS 22.581 and CS 22.583, is unable to reach the controls safely, or that the wrong controls are operated.

(c) Each seat in a sailplane must be designed so that an occupant is comfortably seated, whether he wears a parachute or not. The seat design must allow the accommodation of a parachute worn by an occupant.

(d) The strength of the safety harness must not be less than that following from the ultimate loads for the flight and ground load conditions and for the emergency landing conditions according to CS 22.561(b) taking into account the geometry of the harness and seat arrangement.

(e) Each safety harness installation must be designed so that each occupant is safely retained in his initial sitting or reclining position under any acceleration occurring in operation.

(f) Each seat and safety harness installation must be designed to give each occupant every reasonable chance of escaping serious injury under the conditions of CS 22.561(b)(1) and (b)(2). (See AMC 22.785 (f)).

[Amdt 22/1]

CS 22.786 Protection from injury

(a) Rigid structural members or rigidly mounted items of equipment, must be padded where necessary to protect the occupant(s) from injury during minor crash conditions.

(b) Structural members, which by the nature of their size or shape are capable of piercing the instrument panel, must be designed or positioned such that injury to occupants is unlikely, under the conditions of CS 22.561(b)(2).

CS 22.787 Baggage compartment

(a) Each baggage compartment must be designed for its placarded maximum weight of contents and for the critical load distributions at the appropriate maximum load factors corresponding to the flight and ground load conditions of this Part.

(b) Means must be provided to protect occupants from injuries by movement of the contents of baggage compartments under an ultimate forward acceleration of 15.0 g.

[Amdt 22/1]

CS 22.788 Headrests

a) A headrest must be provided to protect each occupant from rebound injuries in the event of a crash landing. It must be equipped with energy absorbent padding protected against wear and weathering encountered in normal operation. If an adjustable headrest is provided it must be capable of being positioned such that the point of head contact is at eye level. (See AMC 22.788 (a))

b) Each headrest must be so designed to minimize the possibility of clothing or the parachute becoming caught when bailing out. (See AMC 22.788 (b))

c) Each headrest in its most critical position must be designed for an ultimate load of at least 135 daN normal to a vertical plane which touches the contact point of the head.

d) The width and design of the headrest must not unduly restrict vision from either seat.

CS 22.807 Emergency exit

(a) The cockpit must be so designed that unimpeded and rapid escape in emergency situations during flight and in any normal or crash attitude on the ground is possible with the occupant wearing a parachute. (See AMC 22.807 (a)).

(b) The opening, and where appropriate jettisoning, of each canopy or emergency exit must not be prevented by the presence of the appropriate aerodynamic forces and/or the weight of the canopy at speeds up to V_{DF} or by jamming of the canopy with other parts of the sailplane. The canopy or emergency exit attachment fittings must be designed to permit easy jettisoning, where jettisoning is a necessary feature of the design.

(c) The opening system must be designed for simple and easy operation. It must function rapidly and be designed so that it can be operated by each occupant strapped in his seat and also from outside the cockpit.

(d) A canopy or emergency exit jettison system must be actuated by not more than two controls, either or both of which must remain in the open position. The canopy jettisoning controls must be capable of being operated with a pilot effort of between 5 and 15 daN. If two controls are used they must both move in the same sense to jettison the canopy. If there are

controls for each pilot, both controls or sets of controls must move in the same sense. If a single control is used for jettisoning, it must be designed to minimise the risk of inadvertent or unintentional operation towards the jettison position.

(e) In order to enable the occupants to bail out under acceleration conditions, sufficiently strong cabin parts, or grab-handles, must be available and suitably located so that the occupants can lift themselves out of their seats and support themselves. These parts must be designed to an ultimate load of at least 200 daN in the anticipated direction of force application.

[Amdt 22/2]

CS 22.831 Ventilation

(a) The cockpit must be designed so as to afford suitable ventilation under normal flying conditions.

(b) Carbon monoxide concentration must not exceed one part per 20 000 parts air.

CS 22.857 Electrical bonding

(a) Electrical continuity must be provided to prevent the existence of differences of potential between components of the powerplant including fuel and other tanks, and other significant parts of the powered sailplane which are electrically conductive.

(b) If the sailplane is equipped for winch or auto launching, electrical continuity must be provided between the metallic parts of the cable release mechanism and the control column.

(c) The cross-sectional area of bonding connectors, if made from copper, must not be less than 1.33 mm^2 .

CS 22.881 Ground handling

There must be reliable carrying and lifting provisions for the sailplane.

CS 22.883 Ground clearance

(a) There must be at least 0.10 m of ground clearance for the tailplane with the wing-tip touching the ground.

(b) With the wing-tip touching the ground, the associated aileron may not touch the ground when deflected fully down.

CS 22.885 Fairings

Removable fairings must be positively attached to the structure.

CS 22.891 Water ballast tanks: general

Each water ballast tank, its surrounding structure, hoses, valves and fittings, must be able to withstand, without failure, the vibration, inertia, fluid head (partial and full tank, wing deflections in flight and filling procedures) loads from filling procedures and structural loads that may be encountered in service.

CS 22.892 Water ballast tank: tests

Unless loads from CS 22.891 are higher each water tank including hoses, valves and fittings, must be able to withstand a pressure of 0.20 bar without failure or leakage.

CS 22.893 Water ballast tank installation

(a) General. The surrounding aircraft structure must be appropriately protected from any likely damage (corrosion, debonding, etc.) from water ballast leaks.

(b) Water ballast tanks which are not an integral part of the structure must be supported so that the loads resulting from the mass of the water ballast are not concentrated. In addition:

(1) Means must be provided to prevent chafing between each tank and the supporting structure.

(2) Each tank compartment must be vented and drained

(c) For integral tanks the surrounding structure must either be shown to be impervious to ballast absorption, or suitably protected.

CS 22.894 Water ballast tank vents

Integral and other non flexible tanks must be vented.

CS 22.895 Water ballast system

(a) The water ballast control and jettison system must be designed so that any single malfunction will not produce a lateral or longitudinal movement of the centre of gravity that prevents continued safe flight and landing. (See AMC 22.895 (a))

(b) Water contamination of the pitot/static system, or water collection in any parts of the sailplane where it could cause corrosion or produce significant centre of gravity changes, must be prevented.

CS 22.896 Water ballast drains

There must be means to allow drainage of the entire water ballast system with the sailplane in the normal ground attitude.

CS 22.897 Water ballast additives

If water ballast additives are permitted by the Flight Manual, they must be shown to have no adverse or damaging effects on structure or systems critical to flight safety.

Subpart E — Power-plant

GENERAL

CS 22.901 Installation

(a) For the purpose of this CS-22, the sailplane power-plant installation includes each component that –

- (1) is necessary for propulsion; and
- (2) affects the safety of the propulsive unit.

(b) The power-plant must be constructed, arranged and installed to –

- (1) ensure safe operation; and
- (2) be accessible for necessary inspections and maintenance.

CS 22.902 Installation: sailplanes with retractable power-plants or propellers

Powered sailplanes with retractable power-plants or propellers must comply with the following:

(a) Retraction and extension must be possible without risk of damage and without the use of exceptional skill or effort or excessive time.

(b) It must be possible to secure the retraction (extension) mechanism in the extreme positions. There must be a means to inform the pilot that this mechanism is secured in the fully retracted or extended position.

(c) Any doors associated with extension and retraction must not impair extension and retraction and they must be restrained against spontaneous opening.

(d) The installation must be so designed as to prevent the heat of the engine from causing a fire or other hazardous condition.

(e) Fuel or lubricant must not discharge in dangerous quantities from the engine, its components or accessories, when the power-plant is in the retracted position and during extension and retraction.

CS 22.903 Engines

(a) The engine must meet the specifications of Subpart H.

(b) Restarting of the engine in flight must be possible.

CS 22.905 Propellers

The propeller must meet the specifications of Subpart J.

CS 22.925 Propeller clearance

If an unshrouded propeller is to be installed, propeller clearances with the powered sailplane at maximum weight, with the most adverse c.g. and with the propeller in the most adverse pitch position, may not be less than the following:

(a) *Ground clearance.* There must be a clearance of at least 180 mm (for a powered sailplane with a nose-wheel landing gear) or 230 mm (for a powered sailplane with a tail-wheel landing gear) between the propeller and the ground, with the landing gear statically deflected and in the level attitude, normal take-off attitude or taxiing attitude, whichever is most critical. In addition, there must be positive clearance between the propeller and the ground in the level take-off attitude, with:

- (1) the critical tyre completely deflated and the corresponding landing gear strut statically deflected; and
- (2) the critical landing gear strut bottomed and the corresponding tyre statically deflected.

(b) *Structural clearance.* There must be:

- (1) At least 25 mm radial clearance between the blade tips and the sailplane structure, plus any additional radial clearance necessary to prevent harmful vibration;
- (2) At least 13 mm longitudinal clearance between the propeller blades or cuffs and stationary parts of the sailplane; and
- (3) Positive clearance between other rotating parts of the propeller or spinner and stationary parts of the sailplane.

FUEL SYSTEM

CS 22.951 General

(a) Each fuel system must be constructed and arranged to ensure a flow of fuel at a rate and pressure established for proper engine functioning under any normal operating condition.

(b) Each fuel system must be arranged so that no fuel pump can draw fuel from more than one tank at a time. Gravity feed systems may not supply fuel to the engine from more than one tank at a time, unless the air spaces are interconnected in a manner to ensure that all interconnected tanks feed equally.

CS 22.955 Fuel flow

(a) *Gravity systems.* The fuel flow rate for gravity systems (main and reserve supply) must be 150% of the take-off fuel consumption of the engine.

(b) *Pump systems.* The fuel flow rate for each pump system (main and reserve supply) must be 125% of the take-off fuel consumption of the engine at the maximum power established for take-off .

CS 22.959 Unusable fuel

The unusable fuel supply for each tank must be established as not less than that quantity at which the first evidence of malfunctioning occurs under the most adverse fuel feed conditions occurring during take-off , climb, approach and landing involving that tank.

CS 22.963 Fuel tanks: general

(a) Each fuel tank must be able to withstand, without failure, the vibration, inertia, fluid and structural loads that it may be subjected to in operation.

(b) Each flexible fuel tank must be of an acceptable kind.

CS 22.965 Fuel tank tests

(a) Each fuel tank must be able to withstand the following pressures without failure or leakage:

(1) for each conventional metal tank and non-metallic tank with walls not

supported by the sailplane structure, a pressure of 0.25 bar;

(2) for each non-metallic tank with walls supported by the sailplane structure and constructed in an acceptable manner using acceptable basic tank material, and with actual or simulated support conditions, a pressure of 0.14 bar for the first tank of a specific design.

CS 22.967 Fuel tank installation

(a) Each fuel tank must be supported so that the loads resulting from the weight of the fuel are not concentrated. In addition:

(1) there must be pads, if necessary, to prevent chafing between each tank and its supports; and

(2) materials employed for supporting the tank or padding the supporting members must be non-absorbent or treated to prevent the absorption of fuel.

(b) Each tank compartment must be ventilated and drained to prevent accumulation of flammable fluids and vapours. Each compartment adjacent to a tank must be treated in a similar manner.

(c) No fuel tank may be located on the engine side of the firewall. There must be at least 15 mm of clearance between the fuel tank and the firewall.

(d) If the fuel tank is installed in the personnel compartment, it must be demonstrated that adequate ventilation and drainage are provided, that the presence of the tank will in no way interfere with the operation of any part of the powered sailplane, or the normal movement of occupants, and that no leaking fuel will fall directly on to any occupant.

(e) Fuel system components which could cause leakage of fuel as a result of a wheels-up landing must be suitably protected from damage.

CS 22.969 Fuel tank expansion space

Each fuel tank must have an expansion space of sufficient capacity, but of not less than 2% of the tank capacity, to prevent spillage of fuel onto the surfaces of the sailplane due to thermal expansion, sloping ground or any normal ground attitude or manoeuvre, unless the design of the venting system precludes such spillage. It must not be possible to fill the expansion space

inadvertently with the powered sailplane in any normal ground attitude.

CS 22.971 Fuel tank sump

(a) Each fuel tank must have a drainable sump with an effective capacity, in the normal ground and flight attitudes, of 0-10% of the tank capacity, or 120 cm³, whichever is the greater, unless –

(1) the fuel system has a sediment bowl or chamber that is accessible for drainage and has a capacity of 25 cm³;

(2) each fuel tank outlet is located so that, in the normal ground attitude, water will drain from all parts of the tank to the sediment bowl or chamber.

(b) The drainage system must be readily accessible and easy to drain.

(c) Each fuel system drain must have manual or automatic means for positive locking in the closed position.

CS 22.973 Fuel tank filler connection

Fuel tank filler connections must be located outside personnel compartments, except where the fuel tank must be taken out of those compartments for refuelling. Spilled fuel must be prevented from entering the fuel tank compartment or any part of the powered sailplane other than the tank itself.

CS 22.975 Fuel tank vents

Each fuel tank must be vented as close as practicable to the highest point of the tank installation, or from the top part of the expansion space where this is required to be provided. In addition:

(a) Each vent outlet must be located and constructed in a manner that minimizes the possibility of its being obstructed by ice or other foreign matter.

(b) Each vent must be constructed to prevent siphoning of fuel during normal operation.

(c) Each vent must discharge clear of the powered sailplane.

CS 22.977 Fuel strainer or filter

(a) There must be a fuel filter between the fuel tank outlet and the carburettor inlet (or an engine driven fuel pump, if any).

(b) There must be a finger strainer with 3 to 6 meshes per cm at the outlet of each fuel tank. The length of each strainer must be at least twice the diameter of the fuel tank outlet.

(c) Each filter or strainer must be easily accessible for drainage and cleaning.

CS 22.993 Fuel system lines and fittings

(a) Each fuel line must be installed and supported to prevent excessive vibration and to withstand loads due to fuel pressure and accelerated flight conditions.

(b) Each fuel line connected to components of the sailplane between which relative motion could exist must have provisions for flexibility.

(c) Each flexible hose must be approved or must be shown to be suitable for the particular application.

(d) Each fuel line and fitting in any area subject to engine fire conditions must be at least fire-resistant.

CS 22.995 Fuel valves and controls

(a) There must be a means to allow the pilot to shut off rapidly in flight the fuel to the engine.

(b) No shut-off valve may be on the engine side of any firewall.

(c) The portion of the line between the fuel cock and the carburettor must be as short as possible.

(d) Each fuel tank selector must –

(1) Require a separate and distinct action to place the selector in the „OFF“ position; and

(2) Have the tank selector positions located in such a manner that it is impossible for the selector to pass through the „OFF“ position when changing from one tank to another.

OIL SYSTEM

CS 22.1011 General

(a) If an engine is provided with an oil system, it must be capable of supplying the engine with an appropriate quantity of oil at a temperature not exceeding the maximum established as safe for continuous operation.

(b) Each oil system must have a usable capacity adequate for the endurance of the powered sailplane.

CS 22.1013 Oil tanks

(a) Each oil tank must be installed to:

(1) meet the requirements of CS 22.967(a), (b) and (d); and

(2) withstand any vibration, inertia and fluid loads expected in operation.

(b) The oil level must be easy to check without having to remove any cowling parts (with the exception of oil tank access covers) or to use any tools.

(c) If the oil tank is installed in the engine compartment it must be made of fireproof material.

CS 22.1015 Oil tank tests

Oil tanks must be subjected to the tests specified in CS 22.965 for fuel tanks, except that in the pressure tests a pressure of 0.35 bar must be applied.

CS 22.1017 Oil lines and fittings

(a) Oil lines must comply with CS 22.993 and each oil line and fitting must be made of fireproof material.

(b) *Breather lines.* Breather lines must be arranged so that:

(1) condensed water vapour or oil that might freeze and obstruct the line cannot accumulate at any point;

(2) the breather discharge will not constitute a fire hazard if foaming occurs or cause emitted oil to strike the pilot's wind shields;

(3) the breather does not discharge into the engine air induction system;

(4) if the engine is retractable, there must be no discharge of oil from the breather line when the engine is completely retracted.

COOLING

CS 22.1041 General

The power-plant cooling provisions must be able to maintain the temperatures of power-plant components and engine fluids within the temperature limit established by the engine constructor during all likely operating conditions.

CS 22.1047 Cooling test procedure for reciprocating engine powered sailplanes

(a) To determine compliance with the requirement of CS 22.1041, a cooling test must be carried out as follows:

(1) Engine temperatures must be stabilized in flight with the engine at not less than 75% of maximum continuous power.

(2) After temperatures have stabilized, a climb must be begun at the lowest practical altitude and continued for one minute with the engine at take-off power.

(3) At the end of one minute, the climb must be continued at maximum continuous power for at least 5 minutes after the occurrence of the highest temperature recorded.

(b) The climb required in (a) must be conducted at a speed not more than the best rate-of-climb speed with maximum continuous power.

(c) The maximum anticipated air temperature (hot-day conditions) is 38°C at sea-level. Above sea-level, the temperature decreases with a temperature gradient of 6.5°C per 1 000 m altitude. If the tests are conducted under conditions deviating from this value, the recorded temperatures must be corrected according to (d), unless a more rational method is applied.

(d) The temperatures of the engine fluids and of the power-plant components (with the exception of cylinder barrels) must be corrected by adding to them the difference between the maximum ambient anticipated air temperature and the temperature of the ambient air at the time

of the first occurrence of the maximum recorded component or fluid temperature.

INDUCTION SYSTEM

CS 22.1091 Air induction

The air induction system for the engine must supply the air required by the engine under all likely operating conditions.

CS 22.1093 Induction system icing protection

(a) Except as permitted by (b), each engine having a conventional venturi carburettor must be provided with a pre-heater capable, in air free of visible moisture at a temperature of -1°C , of increasing the intake air temperature by 50°C with the engine at 75% of maximum continuous power.

(b) Where the intake air is continuously heated, and it is demonstrated that the temperature rise is adequate, a pre-heater need not be provided.

CS 22.1103 Induction system ducts

(a) Each induction system duct must have a drain to prevent the accumulation of fuel or moisture in the normal ground and flight attitudes. No drain may discharge where it will cause a fire hazard.

(b) Each duct connected to components between which relative motion could exist must have means for flexibility.

CS 22.1105 Induction system screens

If induction system screens are used –

(a) each screen must be upstream of the carburettor;

(b) it must be impossible for fuel to strike the screen.

EXHAUST SYSTEM

CS 22.1121 General

(a) The exhaust system must ensure safe disposal of exhaust gases without fire hazard or carbon monoxide contamination in any personnel compartment.

(b) Each exhaust system part with a surface hot enough to ignite flammable fluids or vapours must be located or shielded so that leakage from any system carrying flammable fluids or vapours will not result in a fire caused by impingement of the fluids or vapours on any part of the exhaust system, including shields for the exhaust system.

(c) Each exhaust system component must be separated by fireproof shields from adjacent flammable parts of the sailplane that are outside the engine compartment.

(d) No exhaust gases may discharge dangerously near any oil or fuel system drain.

(e) No exhaust gases may be discharged where they will cause a glare seriously affecting pilot vision at night.

(f) Each exhaust system component must be ventilated to prevent points of excessively high temperature.

CS 22.1125 Exhaust manifold

(a) The exhaust manifold must be fireproof and corrosion-resistant, and must have means to prevent failure due to expansion by operating temperature.

(b) The exhaust manifold must be supported to withstand the vibration and inertia loads to which it may be subjected in normal operation.

(c) Parts of the manifold connected to components between which relative motion could exist must have means for flexibility.

POWER-PLANT CONTROLS AND ACCESSORIES

CS 22.1141 General

The portion of each power-plant control located in the engine compartment that is required to be operated in the event of fire must be at least fire-resistant.

CS 22.1145 Ignition switches

(a) Each ignition circuit must be independently switched, and must not require the operation of any other switch for it to be made operative.

(b) Ignition switches must be arranged and designed to prevent inadvertent operation.

(c) The ignition switch must not be used as the master switch for other circuits.

CS 22.1149 Propeller speed and pitch controls

(a) Propeller speed and pitch must be limited to values that ensure safe operation under normal operating conditions.

In addition -

(1) If there are propeller speed or pitch controls, their operation must not require undue attention or exceptional skill.

(2) For variable pitch propellers provisions must be made for a positive indication that

(i) the allowable pitch range for engine start; and

(ii) the take-off pitch position

has been reached.

(b) Propellers that cannot be controlled in flight must meet the following requirements:

(1) during take-off and initial climb at V_Y , the propeller must limit the engine rotational speed at full throttle to a value not greater than the maximum allowable take-off rotational speed, and

(2) during a glide at V_{NE} with throttle closed or the engine inoperative, provided this has no detrimental effect on the engine, the propeller must not permit the engine to achieve a rotational speed greater than 110% of the maximum continuous speed.

(3) For powered sailplanes capable of extending and retracting the powerplant during a glide at V_{PE} with the throttle closed, the propeller must not permit the engine to achieve a rotational speed of more than 110% of the max. continuous speed. V_{PE} must not be less than $1.4 V_{S1}$ where V_{S1} is the stalling speed with the wing flaps neutral at maximum weight.

(c) A propeller that can be controlled in flight but does not have constant speed controls must be so designed that -

(1) CS 22.1149(b)(1) is met with the lowest possible pitch selected, and

(2) CS 22.1149(b)(2) is met with the highest possible pitch selected.

(d) A controllable pitch propeller with constant speed controls must comply with the following requirements:

(1) with the governor in operation, there must be a means to limit the maximum engine rotational speed to the maximum allowable take-off speed, and

(2) with the governor inoperative, there must be a means to limit the maximum engine rotational speed to 103% of the maximum allowable take-off speed with the propeller blades at the lowest possible pitch and the powered sailplane stationary with no wind.

CS 22.1163 Power-plant accessories

(a) Each engine-driven accessory must -

(1) be satisfactory for mounting on the engine concerned; and

(2) use the provisions on the engine for mounting.

(b) Electrical equipment subject to arcing or sparking must be installed to minimize the probability of contact with any flammable fluids or vapours that might be present in a free state.

CS 22.1165 Engine ignition systems

(a) Each battery ignition system must be supplemented by a generator that is automatically available as an alternative source of electrical energy to allow continued engine operation if any battery becomes depleted.

(b) The capacity of the batteries and generators must be large enough to meet the simultaneous demands of the engine ignition system and the greatest demands of any other electrical system components that draw from the same source.

(c) There must be a means to warn the pilot if, while the engine is running, malfunctioning of any part of the electrical system is causing continuous discharge of any battery used for engine ignition.

POWER-PLANT FIRE PROTECTION

CS 22.1191 Firewalls

(a) The engine must be isolated from the rest of the sailplane by a firewall, shroud or equivalent means.

(b) The firewall or shroud must be constructed so that no hazardous quantity of liquid, gas or flame can pass from the engine compartment to other parts of the sailplane.

(c) The firewall and shroud must be fireproof and protected against corrosion. (See AMC 22.1191 (c))

CS 22.1193 Cowling and nacelle

(a) Each cowling must be constructed and supported so that it can resist any vibration, inertia and air loads to which it may be subjected in operation.

(b) There must be a means for rapid and complete drainage of each part of the cowling in the normal ground and flight attitudes. No drain may discharge where it will cause a fire hazard.

(c) Cowling must be at least fire-resistant.

(d) Each part behind an opening in the engine compartment cowling must be at least fire-resistant for a distance of at least 600 mm aft of the opening.

(e) Each part of the cowling subjected to high temperatures due to its nearness to exhaust system ports or exhaust gas impingement, must be fireproof.

Subpart F — Equipment**GENERAL****CS 22.1301 Function and installation**

- (a) Each item of required equipment must:
- (1) be of a kind and design appropriate to its intended function;
 - (2) be labelled as to its identification, function, or operating limitations, or any applicable combination of these factors;
 - (3) be installed according to limitations specified for that equipment; and
 - (4) function properly when installed. (See AMC 22.1301(a)(4))
- (b) Instruments and other equipment may not in themselves, or by their effect upon the sailplane, constitute a hazard to safe operation.

CS 22.1303 Flight and navigation instruments

The following are required flight and navigation instruments:

- (a) For all sailplanes:
- (1) an air-speed indicator;
 - (2) an altimeter.
- (b) *For powered sailplanes.* In addition to the instruments required in CS 22.1303 (a):
- (1) a magnetic direction indicator.
- (c) *For sailplanes of Category A.* In addition to the instruments required in CS 22.1303 (a) and (b):
- (1) an accelerometer capable of retaining maximum and minimum values of acceleration for any selected period of flight.
- (d) *For sailplanes equipped with ballast.* In addition to the instruments required in CS 22.1303(a), (b) and (c).
- (1) An outside air temperature gauge.

CS 22.1305 Power-plant instruments

The following are the required power-plant instruments for powered sailplanes:

- (a) a tachometer;
- (b) a fuel quantity indicator for each fuel tank;

(c) an oil temperature indicator except for two stroke engines;

(d) an oil pressure indicator or warning device except for two stroke engines;

(e) a cylinder head temperature indicator for each air-cooled engine when cowl flaps are used;

(f) an elapsed-time indicator;

(g) an oil quantity indicator for each tank, e.g. dipstick,

(h) a manifold pressure indicator for an engine equipped with a variable pitch propeller, where manifold pressure and rotational speed are independently controllable.

(i) for pump-fed engines, one of the following instruments/procedures

- (1) a fuel pressure indicator
- (2) a low fuel pressure warning
- (3) a special preflight procedure

(See AMC 22.1305(i))

CS 22.1307 Miscellaneous equipment

An approved safety harness must be available to each occupant.

INSTRUMENTS: INSTALLATION**CS 22.1321 Arrangement and visibility**
(See AMC 22.1321)

Flight and navigation instruments must be clearly arranged and plainly visible to each pilot.

CS 22.1322 Warning, caution, and advisory lights

If warning, caution, or advisory lights are installed in the cockpit, they must, unless otherwise approved by the Agency, be:

- (a) Red, for warning lights (lights indicating a hazard which may require immediate corrective action);
- (b) Amber, for caution lights (lights indicating the possible need for future corrective action);
- (c) Green, for safe operation lights; and

(d) any other colour, including white, for lights not described in sub-paragraphs (a) to (c) of this paragraph, provided the colour differs sufficiently from the colours prescribed in sub-paragraphs (a) to (c) of this paragraph to avoid possible confusion.

(e) Effective under all probable cockpit lighting conditions.

CS 22.1323 Air-speed indicating system

(a) The air-speed indicating system must be calibrated to indicate true air-speed at sea-level in standard atmosphere with a maximum pitot-static error not exceeding ± 8 km/h or $\pm 5\%$ whichever is greater, throughout the following speed range $1.2 V_S$ to V_{NE} , and with wing-flaps neutral and air brakes closed.

(b) Calibration must be made in flight.

(c) The air-speed indicating system must be suitable for speeds between V_{S0} and at least 1.05 times V_{NE} .

CS 22.1325 Static pressure system

(a) Each instrument provided with static pressure case connections must be so vented that the influence of sailplane speed and the opening and closing of windows, moisture or other foreign matter will not significantly affect the accuracy of the instruments.

(b) The design and installation of a static pressure system must be such that:

(1) positive drainage of moisture is provided;

(2) chafing of the tubing, and excessive distortion or restriction at bends in the tubing, is avoided; and

(3) the materials used are durable, suitable for the purpose intended, and protected against corrosion.

CS 22.1327 Magnetic direction indicator

(a) Each magnetic direction indicator required must be installed so that its accuracy is not excessively affected by the sailplane's vibration or magnetic fields.

(b) The compensated installation must not have a deviation in level flight, greater than 10° on any heading, except that when radio is in use or the engine of a powered sailplane is running,

the deviation may exceed 10° but must not exceed 15° .

CS 22.1337 Power-plant instruments

(a) *Instruments and instrument lines*

(1) Each power-plant instrument line must meet the requirements of CS 22.993.

(2) Each line carrying flammable fluids under pressure must have restricting orifices or other safety devices at the source of pressure to prevent the escape of excessive fluid if the line fails.

(b) Each exposed sight gauge used as a fuel quantity indicator must be protected against damage.

ELECTRICAL SYSTEMS AND EQUIPMENT

CS 22.1353 Storage battery design and installation

(a) Each storage battery must be designed and installed as prescribed in this paragraph.

(b) No explosive or toxic gases emitted by any battery in normal operation, or as the result of any probable malfunction in the charging system or battery installation, may accumulate in hazardous quantities within the sailplane.

(c) No corrosive fluids or gases that may escape from the battery may damage surrounding structures or adjacent essential equipment.

CS 22.1361 Master switch arrangement

(a) In powered sailplanes there must be a master switch arrangement to allow ready disconnection of electric power sources from the main bus. The point of disconnection must be adjacent to the sources controlled by the switch.

(b) The master switch or its controls must be so installed that the switch is easily discernible and accessible to the pilot.

CS 22.1365 Electric cables and equipment

(a) Each electric connecting cable must be of adequate capacity and correctly routed, attached and connected so as to minimize the probability of short circuits and fire hazards.

(b) Overload protection must be provided for each electrical equipment. No protective device may protect more than one circuit essential to flight safety.

(c) Unless each cable installation from the battery to a circuit protective device or master switch, whichever is closer to the battery, is of such power-carrying capacity that no hazardous damage will occur in the event of a short circuit, this length of cable must be so protected or routed in relation to parts of the powered sailplane that the risk of short circuit is minimised. (See AMC 22.1365(c))

CS 22.1385 External lights

If external lights are to be installed they must be approved.

MISCELLANEOUS EQUIPMENT

CS 22.1431 ATC airborne equipment

Each ATC airborne equipment provided must comply with the following:

(a) The equipment and its aerials may neither in themselves nor by their mode of operation or by their effect upon the operating characteristics of the sailplane and its equipment constitute a hazard to safe operation.

(b) The equipment and its control and monitoring devices must be arranged so as to be easily controllable. Their installation must be such that they are sufficiently ventilated to prevent overheating.

CS 22.1441 Oxygen equipment and supply

(a) Oxygen equipment must be approved.

(b) Oxygen equipment must be free from hazards in itself, in its method of operation, and its effect upon other components.

(c) There must be a means to allow the crew to readily determine, during the flight, the quantity of oxygen available in each source of supply.

(d) Oxygen bottles must be installed so as not to be hazardous in crash landings.

CS 22.1449 Means for determining use of oxygen

There must be a means to allow the crew to determine whether oxygen is being delivered to the dispensing equipment.

Subpart G — Operating Limitations and Information

CS 22.1501 General

(a) Each operating limitation specified in CS 22.1505 through CS 22.1525 and other limitations and information necessary for safe operation must be established.

(b) The operating limitations and other information necessary for safe operation must be made available to the pilot as prescribed in CS 22.1541 through CS 22.1585.

CS 22.1505 Air-speed limitations

(a) All flight speeds must be stated in terms of air-speed indicator readings (IAS). (See AMC 22.1505(a))

(b) The never exceed speed, V_{NE} , must not exceed 0.90 times the maximum speed demonstrated in flight tests (V_{DF}).

(c) V_{DF} must not exceed the design maximum speed, V_D and must not be less than 0.9 times the design maximum speed according to CS 22.335(f).

CS 22.1507 Manoeuvring speed

The manoeuvring speed must not exceed the design manoeuvring speed, V_A as defined in CS 22.335(a).

CS 22.1511 Wing-flap operating speed

For each positive wing-flap position (see AMC 22.335), the maximum wing-flap operating speed V_{FE} must not be greater than 0.95 times the speed V_F as defined in CS 22.335(b) for which the structure has been designed.

CS 22.1513 Powerplant extension and retraction speed

The flight speed range for extension and retraction of the powerplant must be established, together with any limitations associated with it.

CS 22.1514 Powerplant extended maximum permitted speed

The powerplant extended maximum speed V_{PE} must be established as required by CS 22.1149(b) for powered sailplanes capable of extending and retracting the powerplant

CS 22.1515 Landing gear operating speed

The maximum landing gear operating speed V_{LO} , if lower than the never exceed speed V_{NE} , must be established for retractable landing gear. It may, however, not be lower than V_T or V_W , whichever is greater.

CS 22.1517 Rough air speed

The rough air speed, V_{RA} may not exceed the design gust speed in free flight V_B as defined in CS 22.335(c).

CS 22.1518 Aerotow and winch-launching speeds

(a) The maximum aerotow speed may not exceed the design speed V_T established in accordance with CS 22.335(d) and may not exceed the speed demonstrated in flight tests.

(b) The maximum winch-launch speed may not exceed the design speed V_W established in accordance with CS 22.335(e) and may not exceed the speed demonstrated in flight tests.

CS 22.1519 Weight and c.g.

(a) The maximum weight determined under CS 22.25(a) must be established as an operating limitation.

(b) The weight of non-lifting structural parts must be established.

(c) The c.g. limitations determined under CS 22.23 must be established as operating limitations.

(d) The empty weight and the corresponding c.g. positions must be determined in accordance with CS 22.29.

CS 22.1521 Power-plant limitations

(a) *General.* The power-plant limitations prescribed in this paragraph must be established so that they do not exceed the corresponding limits for which the engine or propeller is type certificated.

(b) *Take-off and continuous operation.* The take-off and continuous operation must be limited by:

- (1) the maximum rotational speeds (r.p.m.);
- (2) the time limit for the use of take-off power;
- (3) the maximum allowable cylinder head, oil, and liquid coolant temperatures, as appropriate; and
- (4) the maximum allowable manifold pressure or any other parameter limiting the engine power if the engine is equipped with a continuously variable pitch propeller.

CS 22.1523 Solo flight operation

The pilot's seat for solo flight must be designated so that it is appropriate for safe operation, considering the accessibility of the controls that must be used by the solo pilot during all normal and emergency operations, when the pilot is seated at the designated seat station.

CS 22.1525 Kinds of operation

The kinds of operation to which the sailplane is limited are established by the category in which it is eligible for certification and by the installed equipment.

CS 22.1529 Maintenance manual

A maintenance manual containing the information that the applicant considers essential for proper maintenance must be provided. The following must at least be considered in developing the essential information:

- (a) description of systems;
- (b) lubrication instructions setting forth the frequency and the lubricants and fluids which are to be used in the various systems;
- (c) pressures and electrical loads applicable to the various systems;
- (d) tolerances and adjustments necessary for proper functioning of the sailplane;
- (e) methods of levelling, raising and ground towing;
- (f) methods of balancing control surfaces, and maximum permissible values of play at hinge pins and control circuit backlash;
- (g) allowed rigging tension in the cables of cable-operated control systems, as established according to CS 22.411(b);

- (h) identification of primary and secondary structures;
- (i) frequency and extent of inspections necessary for proper maintenance of the sailplane;
- (j) special repair methods applicable to the sailplane;
- (k) special inspection techniques;
- (l) list of special tools;
- (m) rigging data necessary for the proper operation of the sailplane;
- (n) a separate section titled Airworthiness Limitations, segregated and clearly distinguishable from the rest of the document, containing statement of service life limitations, replacement or mandatory overhaul of parts, components and accessories subject to such limitations and structural inspection intervals. Those limitations which are given in documents referred to in (o) must be referenced;
- (o) list of maintenance documents for parts, components and accessories approved independently of the sailplane;
- (p) the materials necessary for small repairs;
- (q) care and cleaning recommendations;
- (r) instructions for rigging and de-rigging;
- (s) information on supporting points for ground transport;
- (t) list of placards and markings and their locations.

MARKINGS AND PLACARDS

CS 22.1541 General

- (a) The sailplane must contain –
 - (1) the markings and placards specified in CS 22.1545 through CS 22.1567; and
 - (2) any additional information, instrument markings, and placards required for the safe operation if it has unusual design, operating, or handling characteristics.
- (b) Each marking and placard prescribed in sub-paragraph (a) of this paragraph –
 - (1) must be displayed in a conspicuous place; and
 - (2) may not be easily erased, disfigured, or obscured.

(c) The units of measurement used to indicate air speed on placards must be the same as those used on the indicator.

CS 22.1543 Instrument markings – general

For each instrument:

(a) when markings are on the cover glass of the instrument, there must be means to maintain the correct alignment of the glass cover with the face of the dial; and

(b) each arc and line must be wide enough and located to be clearly visible to the pilot and not mask any portion of the dial.

CS 22.1545 Air-speed indicator (See AMC 22.1545)

Each air-speed indicator must show the following markings:

(a) For V_{NE} , a radial red line. If V_{NE} varies with altitude, there must be a means to indicate to the pilot the appropriate limitations throughout the operating altitude range. (See AMC 22.1545(a))

(b) for the upper caution range a yellow arc extending from V_{NE} to the allowable rough-air speed V_{RA} ;

(c) for the normal operating range, a green arc with the lower limit at $1.1 V_{S1}$ with maximum weight and for wing-flaps neutral (see AMC 22.335) and landing gear retracted and the upper limit at the rough-air speed V_{RA} ;

(d) for the wing-flap operating range, a white arc with the lower limit at the stall speed $1.1 V_{S0}$ for maximum weight and the upper limit at the allowable wing-flaps extended speed V_{FE} ;

(e) a yellow marking (triangle) for the lowest approach speed (at maximum weight without water ballast) recommended by the manufacturer;

(f) for the best rate-of-climb speed V_Y a blue radial line (for powered sailplanes only) service.

CS 22.1547 Magnetic direction indicator

Unless the deviation is less than 5° on all headings, the deviation values for magnetic headings in not more than 30° increments must be placarded near the magnetic direction indicator.

CS 22.1548 Accelerometer

Each accelerometer required by CS 22.1303(c) must show red radial lines for the maximum positive and negative limit manoeuvring load factors.

CS 22.1549 Power-plant instruments

For each required power-plant instrument, as appropriate to the type of instruments:

(a) each maximum and, if applicable, minimum safe operating limit must be marked with a red radial line;

(b) each normal operating range must be marked with a green arc, not extending beyond the maximum and minimum safe limits;

(c) each take-off and precautionary range must be marked with a yellow arc.

(d) in the case of digital solid state displays, limitations, precautionary and operating ranges required by sub-paragraphs (a), (b) and (c) of this paragraph must be clearly indicated. The display must be readable under all lighting conditions likely to be met in service. (See AMC 22.1549(d))

CS 22.1553 Fuel quantity indicator

Each fuel quantity indicator must be calibrated to read 'zero' during level flight when the quantity of fuel remaining in the tank is equal to the unusable quantity determined in accordance with CS 22.959.

CS 22.1555 Control markings

(a) Each cockpit control, other than primary flight controls, must be clearly marked as to its function and method of operation. (See AMC 22.1555 (a))

(b) The colour markings of cockpit controls must be in accordance with those specified in CS 22.780.

(c) for power-plant fuel controls:

(1) Each fuel tank selector control must be marked to indicate the position corresponding to each tank.

(2) If safe operation requires the use of any tanks in a specific sequence, that sequence must be marked on or near the selector for those tanks.

CS 22.1557 Miscellaneous marking and placards

(a) *Baggage compartment.* Each baggage compartment must have a placard stating the loading limitations.

(b) *Fuel and oil filler openings.* The following apply:

(1) Fuel filler openings must be marked at or near the filler cover with the minimum fuel grade.

(2) Oil filler openings must be marked at or near the filler cover:

- (i) with the grade; and
- (ii) if the oil is detergent or non-detergent.

(c) *Fuel tanks.* The usable fuel capacity of each tank must be marked either at the selector or on the gauge (when provided) or on the tank if this is translucent and visible to the pilot in flight.

(d) *In-flight engine starting.* A placard must be provided stating any limitations to be observed during in-flight engine starting.

(e) *Tyre pressure.* In the case of sailplanes fitted with a landing wheel or wheels, the tyre pressure must be marked on or in the sailplane.

(f) *Aerobatic manoeuvres.* A list of permissible aerobatic manoeuvres, including spins, must be placarded in each sailplane, so that it is plainly visible to the pilot.

(g) *Removable ballast.* If removable ballast is used, the place for carrying ballast must have a placard stating instructions for the proper placement of the removable ballast under each loading condition for which each removable ballast is necessary.

(h) *Weight and cockpit load.* The following additional data must be placarded in each sailplane so that they are plainly visible to the pilot:

- (1) maximum weight.
- (2) maximum and minimum cockpit weight.

CS 22.1561 Safety equipment

Each attachment point for an occupant's parachute static line must be marked red.

CS 22.1563 Airspeed placards

The following speeds, if they are not marked on the air-speed indicator, must be placarded in each sailplane or powered sailplane so that they are plainly visible to the pilot:

(a) the maximum winch-launching speed, V_W (when winch-launching is allowed);

(b) the maximum aerotow speed, V_T (when aerotow is allowed);

(c) the manoeuvring speed;

(d) the maximum landing gear operating speed, V_{LO} , where applicable;

(e) the powerplant extension and retraction speeds $V_{PO\ min}$ and $V_{PO\ max}$, where applicable.

FLIGHT MANUAL**CS 22.1581 General**
(See AMC 22.1581)

(a) *Furnishing Information.* A Flight Manual must be furnished with each sailplane. There must be an appropriate location for stowage of the Flight Manual aboard the sailplane and each Flight Manual must contain the following:

(1) Information required in CS 22.1583 through CS 22.1589 including the explanations necessary for their proper use and the significance of the symbols used.

(2) Other information that is necessary for safe operation because of design, operating or handling characteristics.

(3) A list of effective pages, with identification of those containing approved information according to sub-paragraph (b).

(b) *Approved information.* Each part of the Flight Manual containing information prescribed in CS 22.1583 through CS 22.1587 (a) must be limited to such information and must be approved, identified, and clearly distinguished from each other part of the Flight Manual. All manual material must be of a type that is not easily erased, disfigured, or misplaced and it must be in the form of individual sheets capable of being inserted in a manual provided by the applicant, or in a folder, or in any other permanent form.

(c) *Units.* The units of measurement used in the Flight Manual must be the same as those used on the indicators.

CS 22.1583 Operating limitations

(a) *Air-speed limitations.* The following information must be furnished:

(1) Information necessary for the marking of the air-speed limits on the indicator as required in CS 22.1545, and the significance of each of those limits and of the colour coding used on the indicator. (See AMC 22.1583(a))

(2) The speeds V_A , V_{LO} , V_T , V_W and, where appropriate, $V_{PO\ min}$, $V_{PO\ max}$ and V_{PE} and their significance.

(b) *Weights.* The following information must be furnished:

(1) the maximum weight and the maximum weight of non-lifting parts. If the sailplane is equipped for expendable water-ballast, the maximum weight with and without water-ballast must be furnished.

(2) Any other weight limit, if necessary.

(c) *Centre of gravity.* The established c.g. limits required by CS 22.23 must be furnished.

(d) *Manoeuvres.* Authorised manoeuvres established in accordance with CS 22.3(a) or CS 22.3(b), as appropriate, together with permissible ranges of wing-flap position must be stipulated.

(e) *Flight load factors.* Manoeuvring load factors; the following must be furnished:

(1) The factors corresponding to point A and point G of Figure 1 of CS 22.333(b), stated to be applicable at V_A ;

(2) The factors corresponding to point D and point E of Figure 1, of CS 22.333(b), stated to be applicable at V_{NE} .

(3) The factor with airbrakes extended as specified in CS 22.345.

(4) The factor with wing-flaps extended as specified in CS 22.345.

(5) Markings in accordance with CS 22.1548.

(f) *Kinds of operation.* The kinds of operation (such as VFR, cloud-flying, day-or-night operation) in which the sailplane may be used, must be stated. The minimum equipment

required for the respective kind of operation must be listed.

(g) *Aerotow, aut o-tow and w inch-launching.* The following information on aerotowing, autotowing and winch-launching must be stated:

(1) the maximum permissible nominal strength for the towing cable or weak link;

(2) the minimum towing cable length established in accordance with CS 22.151(d).

(3) Only textile ropes must be used for aerotowing.

(h) *Powerplant limitations.* The following information must be furnished:

(1) Limitations required by CS 22.1521.

(2) Information necessary for marking the instruments required by CS 22.1549 through CS 22.1553.

(i) *Placards.* Placards required by CS 22.1555 through 22.1559 must be presented.

(j) In the case of the two seat sailplane the single pilot seat location and the limitations for solo flight must be furnished as determined under CS 22.1523.

(k) Any limitation associated with the carriage of water ballast necessary for safe operation must be furnished.

CS 22.1585 Operating data and procedures

Information concerning normal and emergency procedures and other pertinent information necessary for safe operation must be furnished, including:

(a) The stall speed in the various configurations.

(b) Any loss of altitude more than 30 m or any pitch attitude more than 30° below the horizon occurring during the recovery part of the manoeuvre prescribed in CS 22.201.

(c) Any loss of altitude of more than 30 m occurring in the recovery part of the manoeuvre prescribed in CS 22.203.

(d) Spinning characteristics, including loss of altitude, any tendency for the spin to turn into a spiral dive, and recommended recovery procedure.

(e) Recommended operational speeds and entry speeds for each authorised manoeuvre.

(f) Slip characteristics in landing configuration, with airbrakes extended. (See AMC 22.1585 (f))

(g) any special procedures or advice to the pilot that may be necessary for aerotowing, wire or bungee launching

(h) The take-off distances in the conditions of CS 22.51, unless classified as a Self-Sustaining Powered Sailplane, in which case there must be a statement in limitations section of the Flight Manual that the sailplane is not approved for take-off by sole means of its own power. In addition the statement must make clear which configurations are approved for launching.

(i) Special procedures to start the engine in flight, if necessary. The maximum demonstrated engine start density altitude, after a prolonged in flight shutdown, and the normal height loss to be expected during extension/unfeathering restart, and the achievement of minimum climb power, must be stated.

(j) For Self-Sustaining Powered Sailplanes, the maximum altitude that can be sustained.

(k) Information on the total quantity of usable fuel.

(l) Special preflight procedures to ensure safe operation of engine and accessories, if necessary.

(m) Advice to the pilot for correct adjustment and positioning of an adjustable headrest, if installed.

(n) Information on the use of water ballast.

CS 22.1587 Performance information

The following information must be furnished:

(a) Airspeed system calibration.

(b) The demonstrated crosswind velocity.

(c) Take-off performance versus density altitude and the influence of other than smooth and hard surfaces.

CS 22.1589 Loading information

The following loading information must be furnished:

(a) The empty weight and the position of the empty weight c.g.

(b) Instruction enabling the pilot of the sailplane to determine the water ballast load versus the useful load.

Subpart H — Engines

GENERAL

CS 22.1801 Applicability (See AMC 22.1801)

This Subpart H is applicable to spark-and compression-ignition engines for powered sailplanes.

CS 22.1805 Instruction manual

An instruction manual containing the information that the applicant considers essential for installing, operating, servicing and maintaining the engine must be provided.

CS 22.1807 Engine ratings and operating limitations

Engine ratings and operating limitations to be established are based on the operating conditions demonstrated during the bench tests prescribed in this Subpart H. They include power ratings and operational limitations relating to speeds, temperatures, pressures, fuels and oils which the applicant finds necessary for the safe operation of the engine.

CS 22.1808 Selection of engine power ratings

Each selected rating must be for the lowest power that all engines of the same type may be expected to produce under the conditions to determine that rating.

DESIGN AND CONSTRUCTION

CS 22.1815 Materials

The suitability and durability of materials used in the engine must –

- (a) Be established on the basis of experience or tests; and
- (b) Conform to approved specifications that ensure their having the strength and other properties assumed in the design data.

CS 22.1817 Fire prevention

(a) The design and construction of the engine and the materials used must minimise the probability of the occurrence and spread of fire

because of structural failure, overheating or other causes.

(b) Each external line or fitting that conveys flammable fluids must be at least fire resistant. Components must be shielded or located to safeguard against the ignition of leaking flammable fluid.

CS 22.1819 Durability

Engine design and construction must minimise the probability of occurrence of an unsafe condition of the engine between overhauls.

CS 22.1821 Engine cooling

Engine design and construction must provide the necessary cooling under conditions in which the powered sailplane is expected to operate.

CS 22.1823 Engine mounting attachments and structure

(a) The maximum allowable loads for engine mounting attachments and related structure must be specified. (See AMC 22.1823(a))

(b) The engine mounting attachments and related structure must be able to withstand the specified loads without failure, malfunction or permanent deformation.

CS 22.1825 Accessory attachment

Each accessory drive and mounting attachment must be designed and constructed so that the engine will operate properly with the accessories attached. The design of the engine must allow the examination, adjustment or removal of each essential engine accessory.

CS 22.1833 Vibration

The engine must be designed and constructed to function throughout its normal operating range of crankshaft rotational speeds and engine powers without inducing excessive stress in any of the engine parts because of vibration and without imparting excessive vibration forces to the structure of the powered sailplane.

CS 22.1835 Fuel and induction system

(a) The fuel system of the engine must be designed and constructed to supply the appropriate mixture of fuel to the combustion chambers throughout the complete operating range of the engine under all starting, flight and atmospheric conditions.

(b) The intake passages of the engine through which air, or fuel in combination with air, passes must be designed and constructed to minimise ice accretion and vapour condensation in those passages. The engine must be designed and constructed to permit the use of a means for ice prevention.

(c) The type and degree of fuel filtering necessary for protection of the engine fuel system against foreign particles in the fuel must be specified. The applicant must show (e.g. within the 50-hour run prescribed in CS 22.1849(a)) that foreign particles passing through the prescribed filtering means will not critically impair engine fuel system functioning.

(d) Each passage in the induction system that conducts a mixture of fuel and air, and in which fuel may accumulate, must be self-draining to prevent a liquid lock in the combustion chambers. This applies to all attitudes that the applicant establishes as those the engine can have when the powered sailplane in which it is installed is in the static ground attitude.

CS 22.1839 Lubrication system (four-stroke engines only)

(a) The lubrication system of the engine must be designed and constructed so that it will function properly in all attitudes and atmospheric conditions in which the powered sailplane is expected to operate. In wet-sump engines this requirement must be met when the engine contains only the minimum oil quantity, the minimum quantity being not more than half the maximum quantity.

(b) The lubrication system of the engine must be designed and constructed to allow installing a means of cooling the lubricant.

(c) The crankcase must be vented to preclude leakage of oil from excessive pressure in the crankcase.

BENCH TESTS**CS 22.1843 Vibration test**
(See AMC 22.1843)

Except where the engine is of a type of construction known not to be prone to hazardous vibration, the engine must undergo a vibration survey to establish crankshaft torsional and bending characteristics over a range of rotational speeds from idling to 110% of the maximum continuous speed or 103% of the maximum desired take-off speed, whichever is the greater. The survey must be conducted with a representative propeller. No hazardous condition may be present.

CS 22.1845 Calibration test

Each engine must be subjected to the calibration tests necessary to establish its power characteristics and the conditions for the endurance test specified in CS 22.1849(a) to (c). The results of the power characteristics calibration tests form the basis for establishing the characteristics of the engine over its entire operating range of crankshaft rotational speeds, manifold pressures, and fuel/air mixture settings. Power ratings are based on standard atmospheric conditions at sea-level.

CS 22.1847 Detonation test (spark ignition only)

The engine must be tested to establish that it can function without detonation throughout the range of intended conditions of operation.

CS 22.1849 Endurance test

(a) The engine must be subjected to an endurance test (with a representative propeller) that includes a total of 50 hours of operation and consists of the cycles specified in CS 22.1849(c).

(b) Additional endurance testing at particular rotational speed(s) may be required depending on the results of the tests prescribed in CS 22.1843, to establish the ability of the engine to operate without fatigue failure.

(c) Each cycle must be conducted as follows:

Sequence	Duration (Minutes)	Operating Conditions
1	5	Starting – Idle
2	5	Take-off power
3	5	Cooling run (Idle)
4	5	Take-off power
5	5	Cooling run (Idle)
6	5	Take-off power
7	5	Cooling run (Idle)
8	15	75% of maximum continuous power
9	5	Cooling run (Idle)
10	60	Maximum continuous power
11	5	Cooling run and stop
Total:	120	

(d) During or following the endurance test the fuel and oil consumption must be determined.

CS 22.1851 Operation test

The operation test must include the demonstration of backfire characteristics, starting, idling, acceleration, overspeeding and any other operational characteristics of the engine.

CS 22.1853 Engine component test

(a) For engine components that cannot be adequately substantiated by endurance testing in accordance with CS 22.1849(a) to (c), the applicant must conduct additional tests to establish that components are able to function reliably in all normally anticipated flight and atmospheric conditions.

(b) Temperature limits must be established for each component that requires temperature controlling provisions to ensure satisfactory functioning, reliability and durability.

CS 22.1855 Teardown inspection

After the endurance test has been completed the engine must be completely dis-assembled. No essential component may show rupture, cracks or excessive wear.

CS 22.1857 Engine adjustment and parts replacement

Service and minor repairs to the engine may be made during the bench tests. If major repairs or replacements of parts is necessary during the tests or after the teardown inspection, or if essential parts have to be replaced, the engine must be subjected to any additional tests the Agency may require.

Subpart J — Propellers

GENERAL

CS 22.1901 Applicability (See AMC 22.1901)

This Subpart J is applicable to propellers for powered sailplanes.

CS 22.1903 Instruction manual

An instruction manual containing the information considered essential for installing, servicing and maintaining the propeller must be provided.

CS 22.1905 Propeller operating limitations

Propeller operating limitations must be established on the basis of the conditions demonstrated during the tests specified in this Subpart J.

DESIGN AND CONSTRUCTION

CS 22.1917 Materials

The suitability and durability of materials used in the propeller must –

- (a) Be established on the basis of experience or tests; and
- (b) Conform to approved specifications that ensure their having the strength and other properties assumed in the design data.

CS 22.1919 Durability

Propeller design and construction must minimise the possibility of the occurrence of an unsafe condition of the propeller between overhauls.

CS 22.1923 Pitch Control

- (a) Failure of the propeller pitch control may not cause hazardous overspeeding under intended operation conditions.
- (b) If the propeller can be feathered the control system must be designed to minimize

(1) consequential hazards, such as a propeller runaway resulting from malfunction or failure of the control system

(2) the possibility of an unintentional operation.

TESTS AND INSPECTIONS

CS 22.1933 General

It must be shown that the propeller and its main accessories complete the tests and inspections prescribed in CS 22.1935 through CS 22.1947 without evidence of failure or malfunction.

CS 22.1935 Blade retention test

The hub and blade retention arrangement of propellers with detachable blades must be subjected to a load equal to twice the centrifugal force occurring at the maximum rotational speed (other than transient overspeed) for which approval is sought, or the maximum governed rotational speed, as appropriate. This may be done either by a whirl test or a static pull test.

CS 22.1937 Vibration load limit test

The vibration load limits of each metal hub and blade, and of each primary load-carrying metal component of non-metallic blades, must be determined for all reasonably foreseeable vibration load patterns.

CS 22.1939 Endurance test

(a) *Fixed-pitch or ground-adj ustable wood or met al propel lers.* Fixed-pitch or ground-adjustable wood or metal propellers must be subjected to one of the following tests:

(1) A 50-hour flight test in level flight or in climb. At least five hours of this flight test must be with the propeller at the rated rotational speed and the remainder of the 50 hours must be with the propeller operated at not less than 90% of the rated rotational speed. This test must be conducted on a propeller of the greatest diameter for which certification is requested.

(2) A 50-hour endurance bench test on an engine at the power and propeller

rotational speed for which certification is sought. This test must be conducted on a propeller of the greatest diameter for which certification is requested.

(b) *Variable pitch propellers.* Wood or metal variable pitch propellers (propellers the pitch of which can be changed by the pilot or by automatic means while the propeller is rotating) must be subjected to one of the following tests:

(1) A 50-hour test on an engine with the same power and rotational speed characteristics as the engine or engines with which the propeller is to be used. Each test must be made at the maximum continuous rotational speed and power rating of the propeller. If a take-off performance greater than the maximum continuous rating is to be established, an additional 10-hour bench test must be made at the maximum power and rotational speed for the take-off rating.

(2) Operation of the propeller throughout the engine endurance tests prescribed in Subpart H.

necessary during the tests or in the teardown inspection, any additional tests that the certifying Agency finds necessary must be conducted.

CS 22.1941 Functional tests

(a) Each variable pitch propeller must be subjected to all applicable functional tests of this paragraph. The same propeller used in the endurance test must be used in the functional test and must be driven by an engine on a test stand or on a powered sailplane.

(b) *Manually controllable propellers.* 500 complete cycles of control throughout the pitch and rotational speed ranges, excluding the feathering range.

(c) *Automatically controllable propellers.* 1500 complete cycles of control throughout the pitch and rotational speed ranges, excluding the feathering range.

CS 22.1945 Teardown inspection







After the endurance test has been completed the propeller must be completely dis-assembled. No essential component may show rupture, cracks or excessive wear.





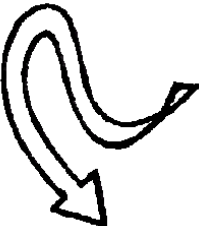

CS 22.1947 Propeller adjustments and parts replacement

The applicant may service and make minor repairs to the propeller during the tests. If major repairs or replacement of parts is found

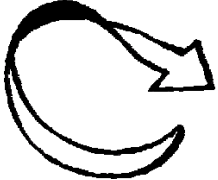
Appendix F
(see AMC 22.3)

GLOSSARY OF AEROBATIC MANOEUVRES

Manoeuvre	Belgium	France	Germany	Italy	Netherlands	Switzerland	United Kingdom
	Vrille	Vrille	Trudeln	Vite	Spin	Vrille	Spin
	Looping	Boucle	Looping	Gran volta	Loop	Looping	Loop
	Ranversement	Ranversement	Turn	Stall turn	Stall turn	Renversement	Stall turn
	Chandelle (climbing)	Chandelle	Chandelle	Chandelle	Chandelle (climbing)	Chandelle	Chandelle (climbing)
	Chandelle (dive out)	Virage vertical	Kehre	Virata sfogata	Chandelle (dive out)	Kehre	Chandelle (dive out)
	Lazy eight	Huit paresseux	Lazy eight	Otto lento	Lazy eight	Lazy eight	Lazy eight

Manoeuvre	Belgium	France	Germany	Italy	Netherlands	Switzerland	United Kingdom
	Rétablissement normal	Rétablissement normal	Aufschwung	Imperiale	Half loop and half roll	Aufschwung	Half loop and half roll
	Retournement	Retournement	Abschwung	Rovesciamento	Half roll and half loop	Retournement	Half roll and half loop
	Tonneau	Tonneau	Rolle gesteuerte	Tonneau	Slow roll	Rolle gesteuerte	Slow roll
	Tonneau déclenché	Tonneau déclenché	Gerissene Rolle	Frullino	Flick roll	Gerissene rolle	Flick roll
	Tonneau barriqué	Tonneau barriqué	Fass- rolle	Tonneau lento	Barrel roll	Fassrolle	Barrel roll
	Cloche manche arrière et manche avant	Cloche manche arrière et manche avant	Männchen vorwärts und rückwärts	Scampanata	Tail slide	Männchen vorwärts und rückwärts	Tail slide

Appendix G
(see AMC 22.1555(a))
COCKPIT PLACARDS

1 FLAPS

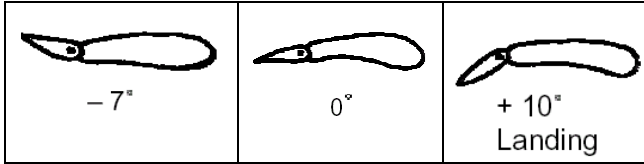

2 AIR BRAKES

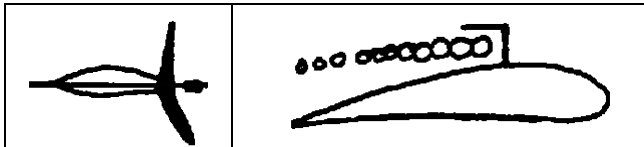

3 BRAKE CHUTE

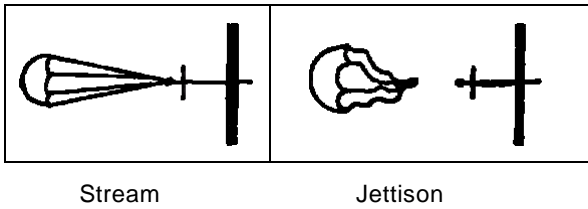

4 WHEEL BRAKE



5 LANDING GEAR

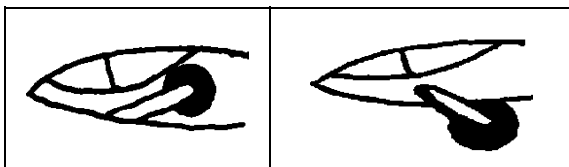

6 TRIMMER

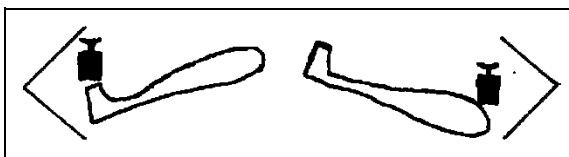

7 WATER BALLAST

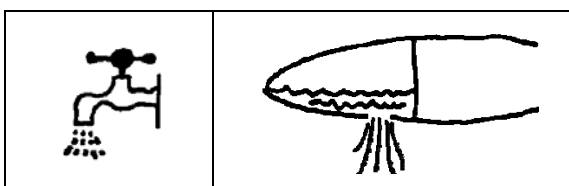

8 RELEASE

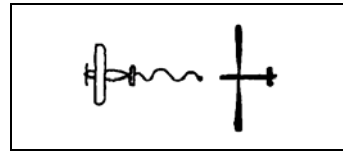

9 CANOPY

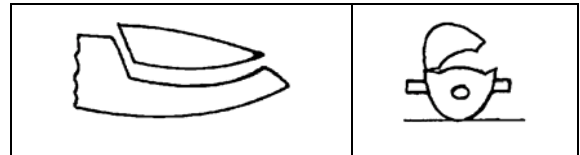

Type 1
Lift off Side hinge

Type 2

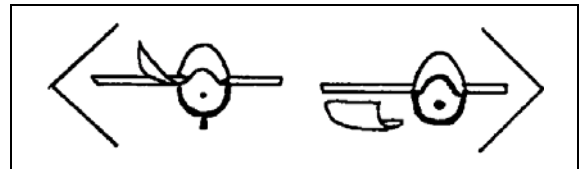

Type 3

Side hinge, Control operated in opposite directions to release and to jettison, as shown by arrows.



Type 4
Rear hinge

10 SEAT BACK

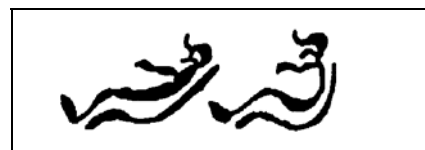

11 PEDAL ADJUST

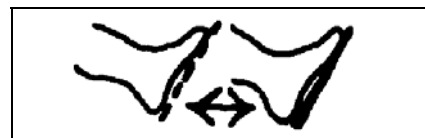

12 AIR VENT

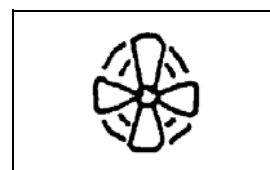

Appendix I

(see CS 22.1(d))

SELF-SUSTAINING POWERED SAILPLANES1. *Engine conditions & speeds*

Two Conditions must be considered -

- (a) Engine extended and stopped (for cases related to engine idling).
- (b) Engine running at maximum power (for cases related to maximum continuous power, or all allowable power settings and also to CS 22.175(d)(5)).

2. *Structure*

CS 22.361(a)(1) is not applicable.

3. *Equipment*

CS 22.1305 Power-plant instruments.

- (a) A tachometer or a suitable substitute -

- (1) A simple indication (e.g. a green light) that the engine is producing the power upon which the performance information is based; and
 - (2) A simple indication (e.g. a red light) that the limiting engine r.p.m. has been reached except where it has been shown that the maximum engine r.p.m. cannot be exceeded at all speeds up to V_{NE} .
- (b) A fuel quantity indicator for each fuel tank. The installation of a simple device, e.g. a transparent tank, a sight gauge or a floating type of indicator is acceptable.
 - (c) An oil temperature indicator or an oil temperature warning device (red light). (Except for two-stroke engines).
 - (d) An oil pressure indicator or warning device (red light). (Except for two-stroke engines).
 - (e) A cylinder head temperature indicator or warning device (red light) for each air-cooled engine when cowl flaps are fitted.
 - (f) An elapsed-engine-time indicator is not required.
 - (g) An oil quantity indicator, e.g. dipstick, unless the engine is a two-stroke type operating on pre-mixed fuel and oil.

Appendix J
(see CS 22.785(f))

Process of H-point determination

For the H-point determination, the thigh contact area and the seat level are the two reference areas in a cockpit.

a) Levelling the sailplane

The sailplane should be adjusted with the longitudinal axis horizontal and the wings level

b) Placing and adjusting of the device

With the thighs below the transitional area of seat level and thigh contact area, the device is placed in the centre of the thigh contact area. The device is then slowly pushed down to the thigh contact area until the two lower ends of the thighs touch the seat pan at the same time. This process should ensure that the thighs fully touch the thigh contact area at all times.

When both of the thighs have optimum contact with the thigh contact area or seat level, the device should be adjusted with the use of a spirit level until horizontal at the contact point and fixed in that position.

c) Marking of H-point and determination of optimum location of lap belt anchorage points

When the device is adjusted, the H-point device axis is pushed to one side until a felt-tip pen that is attached to the device touches the side wall of the seat pan. The H-point should be marked at this position. The same procedures should be repeated for the other side.

Continued adjustment of the device should enable the marking of the H-point for each adjusted position.

A rectangle should be drawn around all H-points marked on the side wall of the seat pan, which should be as small as possible. The intersecting point of the rectangle's diagonal shows the "determined H-point".

For the determination of optimum area for the anchorage point of the lap belts, the device is placed on the seat pan in such a way that the H-point of the device corresponds with the "determined H-point" of the seat pan.

The stencil should then be adjusted with the spirit level attached to it allowing the H-point axis to be fixed with the locking device in the connecting part. The area required for the anchorage point of the lap belt can then be identified on the stencil.

H-Point device

The device is basically composed of the two thighs, the connecting part, and the H-Point axis (see figure 1).

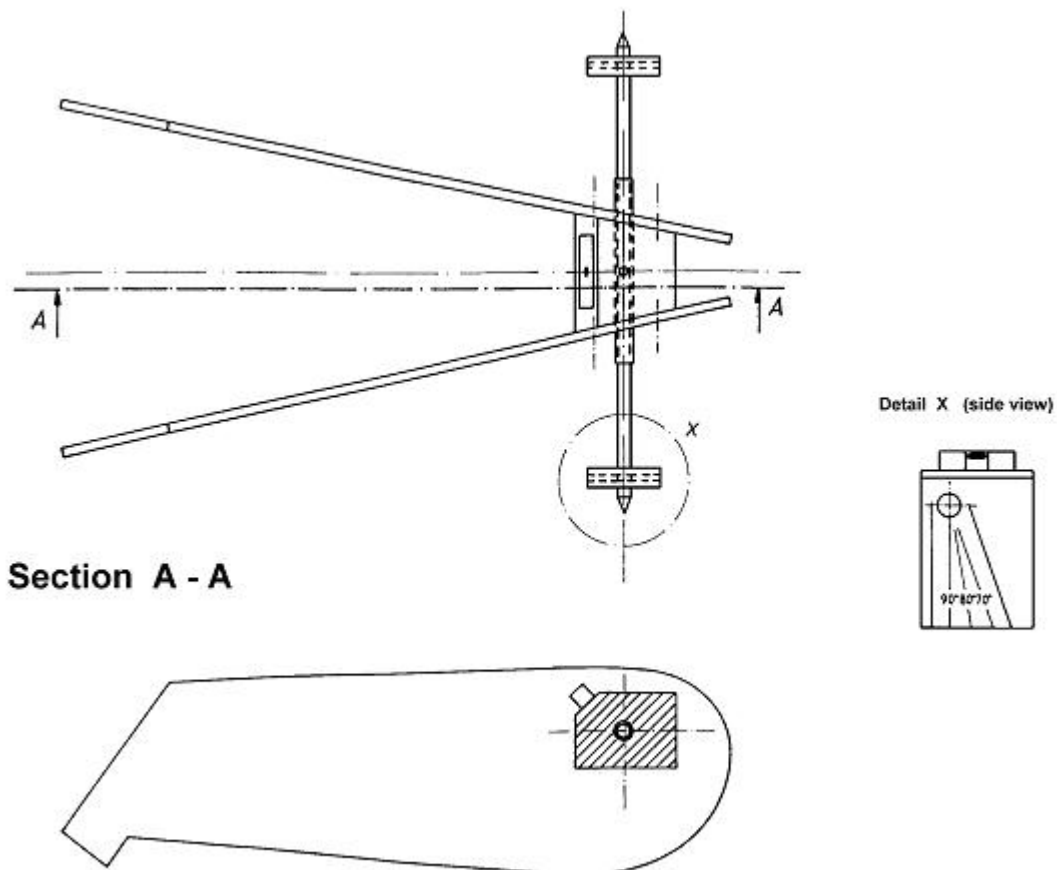

Figure 1

The original constructional drawing of the H-Point device can be ordered by

TÜV Rheinland Kraftfahrt GmbH
Institut für Verkehrssicherheit
Abteilung Luftfahrttechnik
Am Grauen Stein
D-51105 Köln

Appendix K**Aerotowing of Sailplanes by Powered Sailplanes****Applicability:**

For powered sailplanes used for aerotowing sailplanes and for the powered sailplane - sailplane aerotowing combination itself (hereafter the combination is referred to as the "aerotow"), the following requirements apply in addition to those in the main code:

Notes: In the following the term "sailplane" is used for aerotowed sailplanes as well as for aerotowed powered sailplanes.
Aerotowing of more than one sailplane at a time needs further consideration and is not covered by this Appendix.

1. Subpart B - FLIGHT

1.1 (See AMC 22 Appendix K paragraph 1.1)

1.2 CS 22.51 is applicable to the aerotow, except that 22.51 (b)(2) is not applicable.
Compliance must be shown at 500 m above sea level.

1.3 CS 22.65 is applicable to the aerotow.
Compliance must be shown at 500 m above sea level.

1.4 A new paragraph CS 22.77 is added:

CS 22.77 AEROTOWING SPEEDS

The minimum aerotowing speed and the best-rate-of-climb aerotowing speed must be determined by flight test.

The minimum aerotowing speed must not be less than 1.3 V_{S1} of either the powered sailplane or the aerotowed glider, whichever is the higher.

1.5 CS 22.143, except the sideslip condition under subpara (a), is to be applied also to the aerotow.

1.6 CS 22.151 (c) and (d) are applicable to the aerotow.

1.7 CS 22.207 (b) is amended to read:

(b) An audible artificial stall warning giving a clear and distinctive indication must be provided for the powered sailplane unless the stall warning is sufficiently clear and distinctive for the pilot, even under the additional work load when aerotowing.

1.8 CS 22.207 (d) does not apply to the aerotowing powered sailplane.

1.9 CS 22.233 (c) Powered sailplanes used for aerotowing sailplanes must be able to taxi and take-off without additional ground assistance.

2. Subpart C - STRUCTURE

2.1 CS 22.307 applies to the aerotow.

2.2 CS 22.581 is amended to read:

- (a) It must be assumed that the aerotow initially is in stabilised level flight and that an aerotowing cable load of 50 daN (in the absence of a more rational analysis) acts at the aerotowing hook in the following directions:
- (1) rearwards in the direction of the fuselage longitudinal axis;
 - (2) in the plane of symmetry rearwards and downwards at an angle of 20° to the fuselage longitudinal axis;
 - (3) in the plane of symmetry rearwards and upwards at an angle of 40° to the fuselage longitudinal axis; and
 - (4) rearwards and sideways at an angle of 30° to the fuselage longitudinal axis.
- (b) It must be assumed that the aerotow is initially subjected to the same conditions as specified in CS 22.581 (a) and the cable load due to surging suddenly increases to 1.0 Q_{nom} .

Note: It is assumed that only textile aerotowing cables are used.

- (1) The resulting cable load increment must be balanced by linear and rotational inertia forces. These additional loads must be superimposed on those arising from the conditions of CS 22.581 (a).
- (2) Q_{nom} is the rated ultimate strength of the weak links to be used for the aerotowed sailplanes and shown to be suitable in operation.

2.3 CS 22.585 is amended to read:

CS 22.585 Strength of the Aerotowing Hook Attachment

The aerotowing hook attachment must be designed to carry a limit load of 1.5 Q_{nom} as defined in CS 22.581 (b) acting in the directions specified in CS 22.581.

3. **Subpart D - DESIGN AND CONSTRUCTION**

3.1 CS 22.689 applies also for the aerotow release system of the powered sailplane.

3.2 CS 22.711 applies also for the aerotowing powered sailplane and is amended by adding paragraphs (h) and (i):

- (h) Release mechanisms for aerotowing sailplanes must be installed so that there is no interference between the aerotow rope and any control surface throughout their full angular movement, with the aerotowed sailplane in any position as defined in CS 22.581 (a).
- (i) The release mechanism of the aerotowing powered sailplane must be suitably protected against general degradation caused by mud and dirt, etc..
- (j) It must be possible for the pilot to visually check the aerotow cable situation.

3.3 CS 22.713 (c) is applicable to the release mechanism of the aerotowing powered sailplane.

3.4 CS 22.780 is amended by adding the following requirement:

Aerotowing cable release and throttle must be located and arranged to be capable of operation by the same hand.

3.5 A Note is added:

The requirements in Appendix K do not constitute all the requirements necessary to cover the installation of cable retracting devices. Compliance with further requirements may become necessary.

4. **Subpart E - POWERPLANT INSTALLATION**

4.1 A new paragraph CS 22.991 is added:

CS 22.991 Fuel Pumps

- (a) If for the purpose of CS 22.951 a fuel pump is required for proper engine operation, an emergency pump must be provided to immediately supply fuel if the main pump fails. The power supply for the emergency pump must be independent of the power supply for the main pump.
- (b) If both the normal pump and the emergency pump operate continuously, a means or a procedure must be provided to indicate failure of either pump.
- (c) The operation of any fuel pump may not affect the engine operation so as to create a hazard regardless of the engine power setting or the functioning of the other fuel pump.

4.2 CS 22.1047 must be applied to the aerotow.

5. **Subpart F - EQUIPMENT**

5.1 CS 22.1305 (e) is amended to read:

- (e) a cylinder head temperature indicator or an indicator for the critical temperature determined in the cooling test.

5.2 CS 22.1307 is amended by adding the following sentence:

- An easily removable rear-view mirror of sufficient strength and rigidity must be attached and so located that the pilot, when seated with the seat belts fastened, has full and unobstructed view of the aerotowed sailplane in any position as defined in CS 22.581 (a). It must be possible to permanently observe the aerotowed sailplane without other pilot's tasks being affected and without major turning movements of the head.
- An Aerotow rope as specified by the applicant.

6. **Subpart G - OPERATING LIMITATIONS AND INFORMATION**

Note: This information should normally be furnished under Section 9 of the Flight Manual.

6.1 CS 22.1529 applies to powered sailplanes equipped for aerotowing.

6.2 CS 22.1583 is amended by adding the following paragraph (k):

- (k) Aerotowing of sailplanes

The following information concerning aerotowing of sailplanes must be furnished:

- (1) Maximum weight of the powered sailplane (if different from the value under (b) (1))
- (2) Maximum weight of the aerotowed sailplanes
- (3) Maximum weight of the combination powered sailplane and sailplane
- (4) The minimum value for the maximum allowable aerotow speed of the aerotowed sailplane (V_T)
- (5) Information that the powered sailplane shall lift off only after lift-off of the aerotowed sailplane
- (6) Rated ultimate strength for the weak link to be used for the aerotowing cable.
- (7) The specification of the aerotow rope (length, material, weak link)

6.3 As far as applicable for the intended purpose, CS 22.1585 must be applied to the aerotow. In addition, the minimum aerotowing speed and the best-rate-of-climb speed for the aerotow must be furnished. Furthermore, sailplane types whose relevant characteristics are comparable to those of the types used in the flight tests must be furnished as examples.

6.4 CS 22.1587 (c) must be applied to the aerotow and is amended by the following requirements:

In addition, information about the degradation of performance in take-off distance due to long grass, rain drops or contamination of the wing (leading edge), as specified by the applicant, must be furnished.

EASA Certification
Specifications
for
Sailplanes and Powered
Sailplanes

CS-22
Book 2

Acceptable Means of Compliance

SUBPART A – GENERAL**AMC 22.1 (a)**
Applicability

CS-22 is not applicable to aeroplanes classified as hang-gliders and ultralights or microlights. The definitions of these aeroplanes differ from country to country. However, hang-gliders can be broadly defined as sailplanes that can take-off and land by using the pilot's muscular energy and potential energy.

Ultralights or microlights can be described as very low-energy aeroplanes, as some of their main characteristics are strictly limited. The following criteria are often used (alone or in combination): stalling speed, weight to surface area ratio, maximum take-off weight, maximum empty weight, fuel quantity, number of seats.

In addition, both hang-gliders and ultralights/microlights are usually not type-certificated, and CS-22 prescribes minimum standards for the issue of type certificates.

AMC 22.3
Sailplane Categories

- (1) Sailplanes may be used for cloud flying if permitted by the applicable operating rules if the equipment specified therein is installed and if they comply with CS 22.73 (a).
- (2) See CS-22, Book 1, Appendix F, Glossary of Aerobatic Manoeuvres.

SUBPART B – FLIGHT REQUIREMENTS

AMC 22.21

Proof of compliance

- (1) Instrumentation for flight test
 - (a) For test purposes the sailplane should be equipped with suitable instruments for conducting the required measurements and observations in a simple manner. If reliable results cannot be obtained otherwise, the Agency may request the installation of special test equipment.
 - (b) At an early stage in the programme the accuracy of the instruments and their correction curves should be determined, and particular attention should be paid to the position error of the air-speed indication system; the influence of the configuration of the sailplane should also be accounted for.
- (2) Prior to flight test, the following ground tests should be conducted:
 - (a) Measurement of:
 - (i) control circuit stiffness;
 - (ii) friction of controls;
 - (iii) control cable tension of closed control circuits; and
 - (iv) maximum deflection of control surfaces and wing-flaps.
- (3) Functioning tests.

Before starting the flight tests all ground functioning tests should be carried out; especially the functioning of the towing hook should be tested in operation for all cable angles and forces which may occur.

AMC 22.23

Load distribution limits

Significant variations of lateral c.g. are only likely to occur on sailplanes equipped for the carriage of expendable ballast in the wings. Such variations may result from any permitted intentional asymmetric loading or from levels of asymmetric loading which might realistically be expected to occur unintentionally, particularly if flight is permitted with partly-filled tanks. In this case, the range of lateral c.g. considered should not be less than the greater of:-

- (1) Any intentional asymmetric loading that is permitted; and
- (2) The level of asymmetry that might realistically be expected to occur inadvertently, taking account of the design of the system and the likely accuracy of loading. In the absence of a more rational analysis to establish any greater or lesser value, an asymmetry of 10 litres, or 10% of the combined capacity of each symmetrical pair of tanks, whichever is the greater, may be assumed.

AMC 22.143(a)

Controllability and Manoeuvrability

General

Compliance with 22.143(a) should include the extension of airbrakes at speeds up to $1.05 V_{NE}$. The time to extend airbrakes should not exceed 2 seconds.

AMC 22.143(b)

Controllability and Manoeuvrability

General

The characteristics to be noted should include stalling speeds and stalling behaviour.

AMC 22.151(c)(3)

Aerotowing

In demonstrating compliance with this requirement, in addition to the requirements of CS 22.21(a) and (b), the effects of at least the following should be investigated:

- (1) Variations of tow cable length
- (2) Variations of pitch trim settings
- (3) Acceleration along the longitudinal axis of the sailplane
- (4) Snatch loads on tow

(5) Wind gradient due to ground boundary layer effects.

AMC 22.152**Winch launching and auto-tow launching**

For showing compliance with the winch- launching requirements at least 6 winch-launches should be made, covering the range of speeds up to V_w . During these launches a range of release points should be selected along the flight path to cover the normal operating range and the release in emergency.

AMC 22.173(a)(1)**Static longitudinal stability**

Compliance with this requirement can be assumed, if the slope of the curve, stick force versus speed, is at least 1 N per 10 km/h at all speeds up to V_{NE} .

AMC 22.173(b)**Static longitudinal stability**

(1) In flight demonstration, the sailplane should be trimmed in steady flight and the speed should be increased by approximately 20% by moving the control column. The force on the column should then be relaxed very slowly, so as to avoid speed oscillation, and the speed at which the sailplane settles should be noted. The test should be repeated with the speed being decreased by approximately 20%.

(2) Suitable minimum and maximum trimmed speeds are:

(a) Wing-flaps neutral (see AMC 22.335): $1.3 V_{S1}$ and the maximum trim speed but not exceeding $0.84 V_{NE}$.

(b) Wing-flaps in the landing position: $1.3 V_{S0}$ and the minimum trim speed, but not exceeding $0.84 V_{FE}$.

(3) Where no in-flight trimming device is fitted, the test should be made at the trimmed speed. In such case, the speed at which the force on the column is relaxed need not exceed V_{NE} or V_{FE} as appropriate, and need not be less than the minimum speed for steady unstalled flight.

AMC 22.175**Demonstration of static longitudinal stability**

(1) With air brakes extended, qualitative tests are normally acceptable.

(2) Wing-flap positions should include negative positions, where provided. (See AMC 22.335)

AMC 22.201(c)**Wings level stall**

Yawing angles up to 5° should not appreciably change the stalling characteristics.

AMC 22.201(d)**Wings level stall**

The loss of altitude during the stall is the difference between the altitude at which the stall occurs and that altitude at which level flight is regained.

AMC 22.207(b)**Stall warning**

A visual stall warning alone is not acceptable.

AMC 22.221(b)**Spinning****General**

It will normally be sufficient to conduct a number of spins of about two turns in each of the conditions of CS 22.221(b) and subsequently to conduct spins of five turns in the most adverse cases.

AMC 22.221(c),(d),(e) and (f)**Spinning****General**

The standard procedure to recover from a spin is as follows:

Where applicable, close throttle.

Sequentially:

- (1) Check ailerons neutral.
- (2) Apply rudder opposite to the direction of the spin.
- (3) Ease the control column forward until rotation ceases.
- (4) Centralise rudder and ease out of the ensuing dive.

AMC 22.255(a)**Aerobatic manoeuvres**

In the case of a powered sailplane this applies with the engine being operated in an appropriate manner.

SUBPART C – STRUCTURE**AMC 22.307(a)**
Proof of structure

- (1) Substantiating load tests made in accordance with CS 22.307(a) should normally be taken to ultimate design load.
- (2) The results obtained from strength tests should be so corrected for departures from the mechanical properties and dimensions assumed in the design calculations as to establish that the possibility of any structure having a strength less than the design value, owing to material and dimensional variation, is extremely remote.

AMC 22.321(b)
Flight loads
General

For sailplanes altitude is not normally critical for flight loads; for powered sailplanes propeller torque and thrust are normally greatest at sea-level.

AMC 22.335
Design air speeds

- (1) For flaps, the controls for which are intended to be operated in both high and low speed flight, the term 'wing-flaps neutral' in CS 22.335(a) and CS 22.335(b) is defined (unless a recognised aerofoil profile is adopted which thus defines the neutral position) as that wing-flap setting which results when one third of the total range of en-route wing-flap settings is subtracted from the most negative setting.
- (2) For flaps, the controls for which are intended to be operated during low speed flight only, i.e. slotted flaps, split flaps and other flaps where extension is conventional and only in the positive direction, 'wing-flaps neutral' is the retracted or most-upwardly-deflected setting.

AMC 22.347
Unsymmetrical flight conditions

The sailplane is assumed to maintain its attitude after the control surfaces have been activated to initiate roll or yaw until the resulting incremental loads have reached their highest value.

AMC 22.375(a)
Winglets

For the wing the interactive effects between the winglets and the wing should be taken into account, as there are:

- (1) Changes in wing lift distribution;
- (2) Additional bending and torsion moments at the attachment point of the winglet due to aerodynamic and mass loads on the winglet;
- (3) Effects of inertia; and
- (4) Effects of drag on wing torsion.

AMC 22.405
Secondary control systems

Hand and foot loads assumed for design should not be less than the following:

- (1) Hand loads on small hand-wheels, cranks, etc., applied by finger or wrist-force:
P = 15 daN.
- (2) Hand loads on levers and hand-wheels applied by the force of an unsupported arm without making use of the body weight: P = 35 daN.

- (3) Hand loads on levers and hand-grips applied by the force of a supported arm or by making use of the body weight: P = 60 daN.
- (4) Foot loads applied by the pilot when sitting with his back supported (e.g. toe-brake operating loads): P = 75 daN.

AMC 22.411(a)
Control system stiffness and stretch

Control systems will normally be accepted as complying with paragraph CS 22.411(a) if they meet the following:

Under the application of the loads prescribed in CS 22.395, no part of the control system should stretch or shorten by more than 25%. The stretch percentage is defined as $D_e = 100 a/A$ where:

a = comparable movement of the cockpit controls when the pilot effort is resisted by fixing the control surfaces at their zero settings

A = available positive or negative movement of the cockpit controls (measured from their neutral position) when the control surface and the control mechanism are free.

However, stretch or shortening greater than 25% may be acceptable provided special attention is given to compliance with CS 22.143 and CS 22.629 in these conditions.

AMC 22.423
Manoeuvring loads

Method I – The loads should be calculated for instantaneous deflection of the elevator, the following cases being considered:

- (a) speed V_A , maximum upward deflection;
- (b) speed V_A , maximum downward deflection;
- (c) speed V_D , one-third maximum upward deflection;
- (d) speed V_D , one-third maximum downward deflection.

The following assumptions should be made:

- (1) The sailplane is initially in level flight, and its attitude and air speed do not change.
- (2) The loads are balanced by inertia forces.

The sailplanes of Category A, initial conditions of both erect and inverted flight should be considered.

Method II – The loads should be calculated for instantaneous deflection of the elevator such as to cause the normal acceleration to change from an initial value to a final value, the following cases being considered (see Figure 3).

Category U and A:			
Speed	Initial Condition	Final Condition	Load Factor Increment
V_A	A_I	A	$n_1 - 1$
	A	A_I	$1 - n_1$
	A_I	G	$n_4 - 1$
	G	A_I	$1 - n_4$
V_D	D_I	D	$n_2 - 1$
	D	D_I	$1 - n_2$
	D_I	E	$n_3 - 1$
	E	D_I	$1 - n_3$

Category A – Additional cases:			
Speed	Initial Condition	Final Condition	Load Factor Increment
V_A	A_{-1}	A	$n_1 + 1$
	A	A_{-1}	$-(1 + n_1)$
	A_{-1}	G	$n_4 + 1$
	G	A_{-1}	$-(1 + n_4)$
V_D	D_{-1}	D	$n_2 + 1$
	D	D_{-1}	$-(1 + n_2)$
	D_{-1}	E	$n_3 + 1$
	E	D_{-1}	$-(1 + n_3)$

For the purpose of this AMC 22.423 the difference in air speed between V_A and the value corresponding to point G on the manoeuvring envelope should be ignored.

The following assumptions should be made:

- (1) the sailplane is initially in level flight, and its altitude and air speed do not change;
- (2) the loads are balanced by inertia forces;
- (3) The aerodynamic tail load increment is given by

$$\Delta P = \Delta n \, mg \left[\frac{x_{cg}}{l_t} - \frac{S_t}{S} \frac{a_h}{a} \left(1 - \frac{d\varepsilon}{d\alpha} \right) - \frac{\rho_o}{2} \left(\frac{S_t a_h l_t}{m} \right) \right]$$

where:

ΔP = horizontal tail load increment, positive upwards (N)

Δn = load factor increment

m = mass of the sailplane (kg)

g = acceleration due to gravity (m/s²)

x_{cg} = longitudinal distance of sailplane c.g. aft of aerodynamic centre of sailplane less horizontal tail (m)

S_t = horizontal tail area (m²)

a_h = slope of horizontal tail lift curve per radian

$\frac{d\varepsilon}{d\alpha}$ = rate of change of downwash angle with angle of attack

ρ_o = density of air at sea-level (kg/m³)

l_t = tail arm (m)

S = wing area (m²)

a = slope of wing lift curve per radian

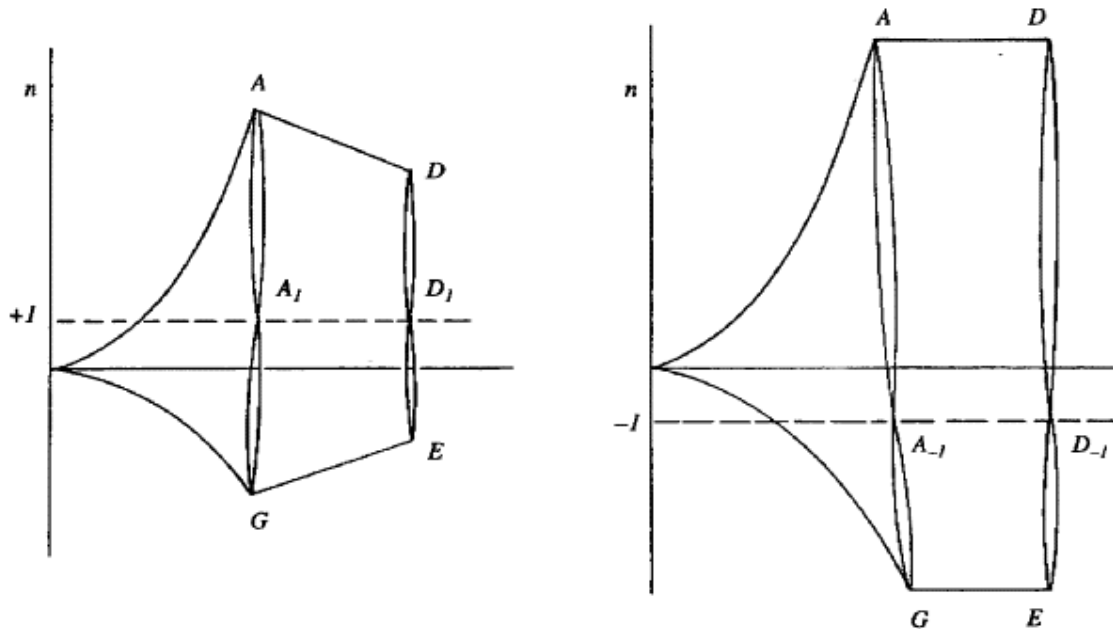
*Category U and A**Category A – Additional Cases***FIGURE 3 PITCHING MANOEUVRES**

AMC 22. 441
Vertical tail surfaces
Manoeuvring load

For sailplanes where the horizontal tail is supported by the vertical tail, the tail surfaces and their supporting structure including the rear portion of the fuselage should be designed to withstand the prescribed loadings on the vertical tail and the rolling moment induced by the horizontal tail acting in the same direction.

For T-tails in the absence of a more rational analysis, the rolling moment induced by side-slip or deflection of the vertical rudder may be computed as follows:

$$M_r = 0.4 S_t \frac{\rho_0}{2} \beta V^2 b_v$$

where:

- M_r = induced rolling moment at horizontal tail (Nm)
- b_v = span of vertical tail, measured from the bottom of the fuselage
- β = side-slip angle (radian)

This formula is only valid for vertical tail aspect ratios between 1 and 1.8 (with span and area measured from the bottom of the fuselage) and horizontal tail with no dihedral and aspect ratio 6 or less. For configurations in excess of these limits more detailed rational analysis will be required.

AMC 22.443
Vertical tail surfaces
Gust loads

For sailplanes where the horizontal tail is supported by the vertical tail, the tail surfaces and their supporting structure including the rear portion of the fuselage should be designed to withstand the prescribed loadings on the vertical tail and the rolling moment induced by the horizontal tail acting in the same direction.

For T-tails in the absence of a more rational analysis, the rolling moment induced by gust load may be computed as follows:

$$M_r = 0.4 S_t \frac{\rho_0}{2} V U b_v k$$

where:

M_r = induced rolling moment horizontal tail (Nm)

b_v = span of vertical tail, measured from the bottom of the fuselage

This formula is only valid for vertical tail aspect ratios between 1 and 1.8 (with span and area measured from the bottom of the fuselage) and horizontal tail with no dihedral and aspect ratio 6 or less. For configurations in excess of these limits more detailed rational analysis will be required.

AMC 22.447 (a)
Combined loads on tail surfaces

- (1) In the absence of rational data the unsymmetrical distribution shall be obtained by multiplying the air load on one side of the plane of symmetry by (1+x) and on the other side by (1-x).
- (2) For point A of the V-n envelope the value of x shall be 0.34 and in the case of an aerobatic category sailplane certificated for flick manoeuvres x shall be 0.5. For point D the value of x shall be 0.15.
- (3) The unsymmetrical horizontal tail load must not be combined with the induced rolling moment at the T-tail.

AMC 22.477
Landing gear arrangement

For the purpose of these requirements landing gears are considered conventional if they consist of:

- (1) A single wheel or twin coaxial wheels at the bottom of the fuselage or two laterally separated single wheels (with or without shock absorbers) located directly, or nearly so, below the c.g. of the sailplane, together with a nose wheel or with auxiliary skids attached to the bottom of the fuselage, one auxiliary skid running from the main wheel (or wheels) forward to the nose and the other running aft to a point approximately below the wing trailing edge. The rear skid may be replaced or supplemented by a suitable tail skid. Both skids may be replaced by suitable reinforcements of the fuselage structure.
- (2) A single elastic main skid at the bottom of the fuselage extending from the nose to a point approximately below the wing trailing edge. This skid may be supplemented by a tail skid or wheel.
- (3) Wing-tip skids

AMC 22.481
Tail-down landing conditions

Where i_y cannot be determined by more rational means, a value of:

$$i_y = 0.225 L_R$$

may be used:

L_R in this case to be taken as the overall length of the fuselage without rudder.

In designing the tail skid, side loads should be accounted for in addition to the vertical load determined as above.

AMC 22.561**Emergency Landing Conditions - General**

For maximum protection of the occupants in survivable crash landings, the main part of the cockpit, defined in AMC 22.561(b)(2), should constitute a safety cell strong enough to comply with paragraph CS 22.561 (b)(2).

The forward part should be sufficiently weaker for it to yield before the main part, but stiff enough for it to absorb considerable energy in doing so. (ref. 2, 4, 5, 8, 9, 11)

Energy-absorbing seats, seat cushions or seat mountings constitute another means of improving safety by reducing the load on the occupants head and spine in a crash (ref. 1, 3, 10) and /or landing with retracted wheels (CS 22.561(c)).

The wording „give every reasonable chance” expresses the limited possibility to determine the quantitative probability of injuries in the process, which is affected by many random inputs (e.g.: physical weight and height of the occupant, his age, influencing the spinal load resistance, specific characteristics of the particular accident etc.).

The required load level has been chosen partly on medical grounds and partly in consideration of what is currently practicable. The objective is to design a cockpit structure that does not collapse under survivable emergency landing conditions.

Furthermore the sailplane design should consider:

- Maximum energy absorption, and
- Occupant protection against serious injuries, namely injuries of head and spine.

For maximum protection of the foremost part of legs during the front part deformation, the feet should have adequate space to move slightly backwards together, without twisting or rocking.

The conditions specified in this paragraph are considered to be most representative of the wide envelope of possible crash loads and impact directions (ref. 5, 9). However the design should be such that the strength is not unduly sensitive to load direction in pitch or yaw.

Further information about different aspects of the crashworthiness of small aircraft design has been accumulated for small airplanes (ref. 6). Published data and procedures are also applicable for sailplane designs.

Applicable information on dynamic computer modelling contained in (ref. 7) might be used to assess applicability of such methods for sailplanes crashworthiness tasks.

Note: Compliance with the revised CS 22.561 requirements would also assure the adequate structural characteristics for safe ground impact when Sailplane Parachute Rescue System is applied. (ref. 5, 13)

References:

- (1) Chandler, R.F.
Injury Criteria Relative to Civil Aircraft Seat and Restraint Human Systems. SAE TP Series No. 851847.(Publication 1985)
- (2) Hansman, R.J., Crawley, E.F., Kampf, K.P.
Experimental Investigation of the Crashworthiness of Scaled Composite Sailplane Fuselages.
Technical Soaring Vol. 14 No 4. ISSN #0744-8996 (1990)
- (3) Segal, A.M., McKenzie, L., Neil, L., Rees, M.
Dynamic Testing of Highly Damped Foam.
Technical Soaring Vol. 19 No 4. ISSN #0744-8996 (1995)
- (4) Röger, W., Conradi, M., Ohnimus, T
Insassensicherheit bei Luftfahrtgerät. Fachhochschule Aachen. Forschungsbericht im Auftrag des Bundesministerium für Verkehr 1996 (Publication December 1996)
- (5) Sperber, M.
Crashworthiness in Glider Cockpits.
OSTIV XXV Congress paper 1997, St Auban
Untersuchung des Insassenschutzes bei Unfällen mit Segelflugzeugen und Motorsegler
Forschungsauftrag Nr.L-2/93-50112/92, TÜV Rheinland, Köln/Rh. Germany, 1998
- (6) Hurley, T.R., Vandenburg, J.M.
Small Airplane Crashworthiness Design Guide, AGATE-WP3.4-034043-036

- Simula Technologies, Phoenix AZ, USA. (Publication April 2002)
- (7) FAA ACE 100
FAA Methodology for Dynamic Seats Certification by Analysis. AC 20 -146, FAA, USA
(Publication date 5/19/03)
 - (8) Boermans, L., Nicolossi, F., Kubrynski, K.,
Aerodynamic Design of High Performance Sailplane Wing Fuselage Combination.
ICAS-98-2, 9, 2 Publication. (Publication 1998)
 - (9) Sperber, M. et al.
Energy absorption on landing accidents with sailplanes and powered sailplanes Rep. No. FE-
Nr.L-2/2005-50.0304/2004, TÜV Rheinland, Köln /Rh., Germany, 2007
 - (10) Segal, A.M.,
Energy Absorbing Seat Cushions for use in Gliders. Technical Soaring Vol. 32, No1/2. ISSN
#0744-8996 (2008)
 - (11) Röger, W.
Safe and Crashworthy Cockpit
Fachhochschule Aachen, Fachbereich Luft-und Raumfahrttechnik, Germany, 2007
 - (12) Röger, W.
Verbesserung der Insassensicherheit bei Segelflugzeugen und Motorsegler durch integrierte
Rettungssysteme, Forschungsauftrag Nr. L-2/90-50091/90, Fachhochschule Aachen, Germany,
1994.

[Amdt No. 22/1]

AMC 22.561(b)(2) **Emergency Landing Conditions**

Compliance with CS 22.561(b)(2) can be shown either by static tests or by analysis using methods validated by previous static test evidence from structures of similar design. The analysis should, at minimum, show that ultimate material strength properties and stability limits, such as buckling of the canopy sill, are not exceeded. The weight used when showing compliance to CS 22.561(b)(2) should represent the maximum weight derived from CS 22.25(a)(2) as far as these weights contribute to the loading of the safety cell.

For conventional (semi-reclined) seating configurations it is sufficient to demonstrate, that the main part of the cockpit, extending at least from the front control pedals (adjusted to the intermediate longitudinal position) to the rearmost headrest mounting or the wing attachment section whichever is further aft, including the harness attachments (ref. 1), meets the requirements of CS 22.561(b).

References:

- (1) Sperber, M.
Restraint Systems in Gliders under Biomechanical Aspects.
Technical Soaring Vol. 19 No 2. ISSN #0744-8996 (1995)

[Amdt No.:22/1]

SUBPART D - DESIGN AND CONSTRUCTION**AMC 22.611
Accessibility**

The provision of access panels suitably located and in sufficient numbers to enable the proper inspection of structural elements, to allow inspection, adjustment and lubrication of critical parts of the control system, as necessary for continued airworthiness, and the replacement of parts as required, is an acceptable interpretation of, and means of compliance with CS 22.611. 'Inspection' is meant to include daily and other periodic checks.

Where it is impracticable to provide means for direct visual inspection, non destructive inspection aids or special inspection methods may be used to inspect structural elements, when the inspection can be shown to be effective, if such inspection aids are easily obtainable.

**AMC 22.613(b)
Material strength properties and design values**

Material specifications should be those contained in documents accepted either specifically by the Agency or by having been prepared by an organisation or person which the Agency accepts has the necessary capabilities. In defining design properties these material specification values should be modified and/or extended as necessary by the constructor to take account of manufacturing practices (for example method of construction, forming, machining and subsequent heat treatment).

**AMC 22.613(c)
Material strength properties and design values**

Temperatures up to 54°C are considered to correspond to normal operating conditions.

**AMC 22.619(a)
Special factors**

Appropriate combinations of the special factors should include all those of the following appropriate to the part:

- (1) the casting factor derived in accordance with CS 22.621;
- (2) the highest pertinent special factor prescribed in CS 22.623, CS 22.625, CS 22.657, CS 22.693 or CS 22.619(b); and
- (3) the two-hinge factor prescribed in CS 22.625 (e).

**AMC 22.685(d)
Control system details**

- (1) An automatic connection device in each part of the primary pitch control system which is connected during the rigging of the sailplane is an acceptable means of compliance with this requirement. Means should be provided to guarantee the proper functioning of the primary pitch control system. Normally this should be provided by visual inspection.
- (2) For the other control systems it should be shown that no hazardous situation can occur, due to restrictive movement or jamming of the control system, when a part of the control system is not connected during the rigging of the sailplane.

**AMC 22.689(b)
Cable systems**

The inside diameter of the pulley groove should not be less than 300 times the diameter of each elemental strand.

AMC 22.723
Shock absorption test

Where the shock absorption characteristics are not essentially affected by the rate of compression, static tests may be used, but where the characteristics are so affected dynamic tests should be done.

AMC 22.773(b)
Cockpit View

Compliance with CS 22.773(b) may be provided by the canopy having a suitable opening.

AMC 22.775(a)
Windshields and windows

Windshields and windows made of synthetic resins are accepted as complying with this requirement.

AMC 22.777(a)
Cockpit controls

The preferred arrangement of the powerplant controls is, from left to right, carburettor heat or alternate air control (if required), power, propeller, and mixture control.

AMC 22.777(c)
Cockpit controls

The need for a dual trim control may be waived when it is demonstrated that, with the trimmer in the most adverse position, the elevator control forces are sufficiently small and that there is no difficulty in control.

AMC 22.777(d)
Cockpit controls

Throttle control systems which have been demonstrated to have inherently constant friction levels throughout their life such as Bowden type push/pull cables, are accepted as providing an equivalent level of safety to that of a 'means of adjusting the freedom of operation of the throttle control in flight'.

AMC 22.780
Color marking and arrangement of cockpit controls

When two controls are necessary to jettison the canopy and one of those is also used as the normal canopy opening control, its colour should be white with a red ring or band around the handle.

AMC 22.781
Cockpit control knob shape

The control should take the form of a T-shaped handle.

AMC 22.785(f)
Seats and safety harnesses

- (1) The arrangement of the safety harness installation should minimise the probability of the occupant's body from either sliding underneath the belts or sliding laterally when subjected to inertia loads acting in the forward or sideward direction, respectively.
- (2) For semi-reclined seating positions the anchorage points of the lap belt should be located well below and behind the H-Point at an angle between 80 ± 10 degrees to the datum line through the H-Point parallel to the longitudinal axis of the sailplane.

The H-Point (Hip-point) is the pivot between the torso centre line and the thigh centre line of the occupant.

The determination of the H-Point, or the anchorage point of the lap belt, should be made by a rational method. An acceptable means is contained in CS-22, Book 1, Appendix J.

- (3) The anchorage points of the shoulder belts should be located below and behind the pilots shoulders at an angle of $15^{\circ} +2^{\circ}/-0^{\circ}$ to a line parallel to the longitudinal axis of the sailplane for a 50 percentile male. The lateral separation should be not more than 200 mm.
- (4) The design of the shoulder harness supporting structure has to consider the combination of the occupant ultimate inertia forces corresponding to a forward acceleration from CS 22.561(b)(1) combined with fuselage loads and possible side deformation resulting from the ultimate load defined under CS 22.561(b)(2).

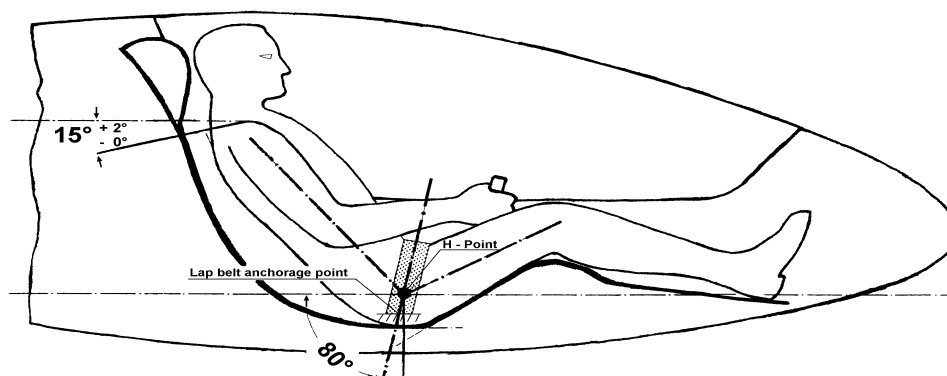

[Amdt No. 22/1]

AMC 22.788 **Headrests**

- a) If possible, the structure of the headrest should be integrated into the backrest of each seat.
- b) Each headrest should be so designed that protection from injuries referred to in paragraph CS 22.788(a) is ensured for each occupant irrespective of whether or not a parachute is worn.

AMC.807 (a) **Emergency Exits**

When assessing ground escape, the possibility of the aircraft coming to rest in an inverted (turnover) position should be determined.

If it is determined that an aircraft design is not susceptible to turnover, then no further action is necessary. If however turnover remains a distinct possibility or is questionable, provisions should be made in the basic aircraft design to allow the occupants to make a rapid escape from a turnover position. This may include the design of the emergency exit or fuselage, the use of materials which are readily breakable or by installing weak points in the fuselage or canopy.

As an alternative to provisions within the basic aircraft design, it is acceptable to install qualified escape equipment (e.g. crash axe) that would permit the occupant(s) to make a rapid escape from the inverted position. In such a case, it would not be necessary to consider the wearing of a parachute, as escape could be made more rapid if the occupant(s) released their parachute(s) prior to egress rather than attempt to enlarge an escape opening or risk getting entangled. In order to qualify escape equipment, it must be shown by test or by similarity with previous tests, that the equipment can perform its intended function.

[Amdt 22/2]

AMC 22.895(a)
Water ballast

Depending on the complexity of the water ballast system it would normally be necessary to carry out failure modes and effects analysis which should include likely dormant failure modes.

If water ballast is carried in more than one tank:

- (1) simultaneous release of water ballast should be achieved by a single lever operation.
- (2) the rate of jettison of water ballast should not result in the centre of gravity moving outside the limitations established under CS 22.23.

SUBPART E - POWER-PLANT**AMC 22.1191(c)****Firewalls**

The following materials are accepted as fireproof, when used in firewalls or shrouds, without being tested -

- (1) stainless steel sheet, 0.38 mm thick;
- (2) mild steel sheet (coated with aluminium or otherwise protected against corrosion) 0.5 mm thick;
- (3) steel or copper base alloy firewall fittings.

SUBPART F - EQUIPMENT**AMC 22.1301(a)(4)****Function and installation**

- (1) The correct functioning should not be impaired by icing, heavy rain or high humidity.
- (2) When ATC equipment is installed it should be shown that the electrical system is such that the operation of this equipment is not adversely affected.

AMC 22.1305(i)**Power-plant instruments**

If a special preflight procedure is established, it should be furnished as required by CS 22.1585 (I) and CS 22.1541.

AMC 22.1321**Arrangement and visibility**

In order to comply with this requirement, duplication of the flight instruments may be necessary for sailplanes and powered sailplanes with dual control.

AMC 22.1365 (c)**Electric cables and equipment**

This is normally achieved by limiting unprotected battery to master switch cables, of an adequate capacity, to a maximum length of 0.5 m.

In any event the capacities of protected cables should be such that no hazardous damage will occur to the powered sailplane, nor ill effects to the occupants from the generation of noxious fumes, due to electrical overloading of cables before a circuit protective device will operate.

SUBPART G - OPERATING LIMITATIONS AND INFORMATION

AMC 22.1505(a) Air-speed limitation

Speeds (EAS) determined from structural limitations should be suitably converted.

AMC 22.1545(a) Air-speed indicator

A placard located close to, or suitable markings on the face of, the airspeed indicator, giving reductions of V_{NE} with altitude, are acceptable means of compliance with the second sentence of this paragraph.

AMC 22.1545 Air-speed indicator

An example of the presentation of an air-speed indicator complying with this requirement is shown in Figure 1.

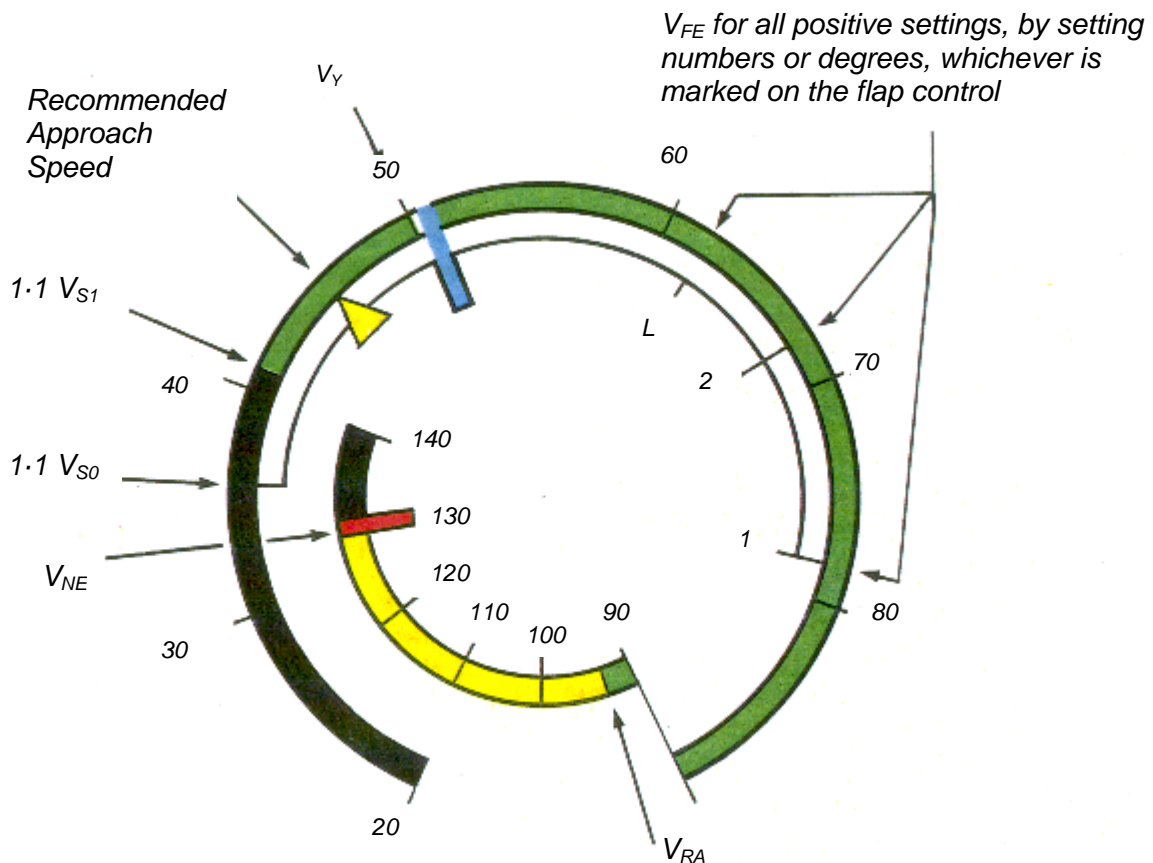

FIGURE 1 EXAMPLE OF AIR SPEED INDICATOR MARKINGS

AMC 22.1549(d) Power-plant instruments

In the case of digital solid state displays the required red line should be represented by a steady red light near or on the instrument, or by blinking of the whole display. The precautionary range should be indicated near or on the instrument. All instrument indications in that range should be designed to

obtain the attention of the pilot. In addition, the operating range data should be placarded near the display using the colours described in CS 22.1549 (a), (b) and (c).

Oil temperature, oil pressure and cylinder head temperature indications will be acceptable if achieved by means of warning lights instead of analogue or digital indications if:

- (1) The required red line is represented by a steady red light.
- (2) The normal operating range is represented by a steady green light.
- (3) The precautionary range is represented by a steady yellow light.
- (4) A 'press to test' facility is provided for the warning light displays.

AMC 22.1555(a)
Control markings

Identification of the controls should consist of easily understandable and commonly used symbols, such as those shown in CS-22, Book 1, Appendix G, in preference to placards.

AMC 22.1581
Flight manual
General

An acceptable format for a Flight Manual is given on the next pages.

SPECIMEN FLIGHT MANUAL FOR A SAILPLANE (INCLUDING A POWERED SAILPLANE)

Model:

Serial No:

Registration:

Document No. (If appropriate):

Date of Issue:

Pages identified by 'Appr.' are approved by:

Signature:

Agency:

Stamp:

Original date of approval:

This sailplane is to be operated in compliance with information and limitations contained herein .

(Model Designation or Document No.)

0.1 *Record of revisions*

Any revision of the present manual, except actual weighing data, must be recorded in the following table and in case of approved Sections endorsed by the Agency.

The new or amended text in the revised page will be indicated by a black vertical line in the left hand margin, and the Revision No. and the date will be shown on the bottom left hand of the page.

Rev. No.	Affected Section	Affected Pages	Date of Issue	Approval	Date of approval	Date of Insertion	Signature

(i)

(Model Designation or Document No.)

0.2

List of Effective Pages

Section	Page	Date of Issue	Section	Page	Date of Issue
0	(i) (ii) (iii)				
1	1.1 1.2 1.3				
2	2.1 Appr. 2.2 Appr. 2.3 Appr. 2.4 Appr. 2.5				
3	3.1 Appr. 3.2				
etc.					

(ii)

(Model Designation or Document No.)

0.3

Table of Contents

	Section
General (a non-approved section)	1
Limitations (an approved section)	2
Emergency procedures (an approved section)	3
Normal procedures (an approved section)	4
Performance (a partly approved section)	5
Weight and balance/equipment list (a non-approved section)	6
Sailplane and systems description (a non-approved section)	7
Sailplane handling, care and maintenance (a non-approved section)	8
Supplements	9

(iii)

(Model Designation or Document No.)

Section 1

1. General
- 1.1 Introduction
- 1.2 Certification basis
- 1.3 Warnings, cautions and notes
- 1.4 Descriptive data
- 1.5 Three-view drawing

1.1

(Model Designation or Document No.)**1.1 Introduction**

The sailplane flight manual has been prepared to provide pilots and instructors with information for the safe and efficient operation of the sailplane.

This manual includes the material required to be furnished to the pilot by CS-22. It also contains supplemental data.

1.2 Certification basis

This type of sailplane has been approved by (Agency) in accordance with CS-22 including Amendment and the Type Certificate No. has been issued on (date) Category of Airworthiness (Utility, Aerobatic) Noise Certification Basis.....

1.3 Warnings, cautions and notes

The following definitions apply to warnings, cautions and notes used in the flight manual.

WARNING : means that the non-observation of the corresponding procedure leads to an immediate or important degradation of the flight safety.

CAUTION : means that the non-observation of the corresponding procedure leads to a minor or to a more or less long term degradation of the flight safety.

NOTE : draws the attention on any special item not directly related to safety but which is important or unusual.

1.4 Descriptive data

(Kind of sailplane or powered sailplane)

(Design details)

(Engine and propeller)

(Span, length, height, MAC, wing area, wing loading)

(Model Designation or Document No.)

1.5 *Three-view drawing*

1.3

(Model Designation or Document No.)

Section 2

- 2. Limitations
 - 2.1 Introduction
 - 2.2 Airspeed
 - 2.3 Airspeed indicator markings
 - 2.4 Power-plant, fuel and oil
 - 2.5 Power-plant instrument markings
 - 2.6 Weight
 - 2.7 Centre of gravity
 - 2.8 Approved manoeuvres
 - 2.9 Manoeuvring load factors
 - 2.10 Flight crew
 - 2.11 Kinds of operation
 - 2.12 Minimum equipment
 - 2.13 Aerotow and winch- and autotow-launching
 - 2.14 Other limitations
 - 2.15 Limitations placards

2.1

(Model Designation or Document No.)**2.1 Introduction**

Section 2 includes operating limitations, instrument markings, and basic placards necessary for safe operation of the sailplane, its engine, standard systems and standard equipment.

The limitations included in this section and in Section 9 have been approved by (Agency).

2.2 Airspeed

Airspeed limitations and their operational significance are shown below:

	Speed	(IAS)	Remarks
V_{NE}	Never exceed speed		Do not exceed this speed in any operation and do not use more than $\frac{1}{3}$ of control deflection
V_{RA}	Rough air speed		Do not exceed this speed except in smooth air, and then only with caution. Examples of rough air are lee-wave rotor, thunderclouds etc.
V_A	Manoeuvring speed		Do not make full or abrupt control movement above this speed, because under certain conditions the sailplane may be overstressed by full control movement.
V_{FE}	Maximum Flap Extended speed (if applicable give different flap settings)		Do not exceed these speeds with the given flap setting.
V_W	Maximum winch-launching speed		Do not exceed this speed during winch- or autotow-launching
V_T	Maximum aerotowing speed		Do not exceed this speed during aerotowing
V_{LO}	Maximum landing gear operating speed		Do not extend or retract the landing gear above this speed
V_{POmax}	Maximum powerplant extension and retraction speed		Do not extend or retract the retractable powerplant outside of this speed range
V_{POmin}	Minimum powerplant extension and retraction speed		
V_{PE}	Powerplant extended maximum permitted speed		Do not exceed this speed with the powerplant extended.

(If further speed limitations are required they must be added hereon).

Appr. 2.2

(Model Designation or Document No.)**2.3 Airspeed indicator Markings**

Airspeed indicator markings and their colour- code significance are shown below:

Marking	(IAS) value or range	Significance
White arc		<i>Positive Flap Operating Range.</i> (Lower limit is 1.1 V_{S0} in landing configuration at maximum weight. Upper limit is maximum speed permissible with flaps extended positive)
Green arc		<i>Normal Operating Range.</i> (Lower limit is 1.1 V_{S1} at maximum weight and most forward c. g. with flaps neutral. Upper limit is rough air speed)
Yellow arc		Manoeuvres must be conducted with caution and only in smooth air
Red line		Maximum speed for all operations
Blue line		Best rate-of-climb speed V_Y
Yellow triangle		Approach speed at maximum weight without water ballast

2.4 Power-plant, fuel and oil

Engine Manufacturer:

Engine Model:

Maximum Power, Take- off:

Continuous:

Maximum Engine rpm at MSL, Take-off:

Continuous:

Maximum Cylinder Head Temperature:

Maximum Oil Temperature:

Oil Pressure, Minimum:

Maximum:

Fuel (specification):

Oil grade (specification):

(if applicable: Fuel-oil mixture specification)

Propeller manufacturer:

Propeller model:

Appr. 2.3

(Model Designation or Document No.)*2.5 Power-plant instrument markings*

Power-plant instrument markings and their colour-code significance are shown below:

Instrument	Red Line Minimum Limit	Green Arc Normal Operating	Yellow Arc Caution Range	Red Line Maximum Limit
Tachometer	- - -	(range)	(range)	
Oil temperature	- - -		- - -	
Cylinder head temperature	- - -		- - -	
Oil pressure			- - -	
Fuel quantity	(unusable fuel mark)	- - -	- - -	- - -

Appr. 2.4

(Model Designation or Document No.)**2.6 *Mass (weight)***

Maximum take-off mass:
(with water ballast)
(without water ballast)

Maximum landing mass:

Maximum mass of all non-lifting parts:

Maximum mass in baggage compartment:

2.7 *Centre of gravity*

Centre of gravity range (for flight)

A table of c.g. ranges at different empty weights

Reference datum

2.8 *Approved manoeuvres*

This sailplane is certified in the category.

(If aerobatic figures are approved, they must be listed herein with reference to Section 4 for recommended entry speeds).

2.9 *Manoeuvring load factors*

(Maximum positive and negative load factors under different conditions must be listed herein).

2.10 *Flight crew*

(In the case of a two-seater the limitations for solo flights must be given herein).

2.11 *Kinds of operation*

(Herein must be listed the approved kinds of operation according to CS 22.1525).

2.12 *Minimum equipment*

(Herein must be listed the minimum equipment such as airspeed indicator, altimeter, compass etc. required for normal cross-country flights and the required additional equipment for cloud flying or aerobatic flights, if applicable).

2.13 *Aerotow and winch- and autotow-launching*

(Herein must be listed the approved towing speeds, the towing cable or weak link strength and the minimum cable length).

Appr. 2.5

2.14 *Other limitations*

(Provide a statement of any limitation required by CS 22.1581(c), but not specifically covered in this Section).

Intentional manoeuvres not approved with water ballast, or limitations associated with asymmetric water ballast conditions must be listed.

Weight and Balance control procedures for in flight C.G. control must be stated if necessary.

The time required to jettison the water ballast.

Any approved water ballast additives, proportions to be used and any associated temperature and/or time limitations.

Any outside temperature/time limitation associated with the carriage of water ballast.

2.15 *Limitations placard*

(The operating limitations placard required in CS 22.1559 must be illustrated).

Water ballast jettison time.

Note: For further placards refer to Maintenance Manual Doc. No....

(Model Designation or Document No.)

Section 3

- 3. Emergency procedures
 - 3.1 Introduction
 - 3.2 Canopy jettison
 - 3.3 Bailing out
 - 3.4 Stall recovery
 - 3.5 Spin recovery
 - 3.6 Spiral dive recovery
 - 3.7 Engine failure (carburettor icing)
 - 3.8 Fire
 - 3.9 Other emergencies

3.1

(Model Designation or Document No.)**3.1 Introduction**

Section 3 provides checklist and amplified procedures for coping with emergencies that may occur.

3.2 Canopy jettison

(Procedures must be provided for jettisoning the canopy in an emergency).

3.3 Bailing out

(Procedures must be provided for safely getting out and clear of the sailplane).

3.4 Stall recovery

(The stall recovery procedure must be explained).

3.5 Spin recovery

(The recovery procedure from an unintentional spin must be explained. A statement must be included that the sailplane is not, or not in all configurations, approved for spins. If applicable, the influence of water-ballast should be taken into account).

3.6 Spiral dive recovery

(The recovery procedure from a spiral dive must be explained. The influence of water-ballast should be taken into account).

3.7 Engine failure

(Procedures must be provided for all cases of engine failure during take-off and flight, for powered sailplanes only).

3.8 Fire

(Procedures must be provided for coping with cases of smoke or fire in the cockpit or in the engine compartment in the following flight phases:

- (a) on the ground
- (b) during take-off
- (c) in flight).

3.9 Other emergencies

(Emergency procedures and other pertinent information necessary for safe operations must be provided for emergencies peculiar to a particular sailplane design, operating or handling characteristics. Continued safe take-off, flight and landing procedures for any malfunction which can cause an asymmetric flight condition must be described in the emergency section of the flight manual).

Appr. 3.2

(Model Designation or Document No.)

Section 4

- 4. Normal procedures
- 4.1 Introduction
- 4.2 Rigging and de-rigging
- 4.3 Daily inspection
- 4.4 Pre-flight inspection
- 4.5 Normal procedures and recommended speeds
 - 4.5.1 Launch/engine starting, run up, taxiing procedures
 - 4.5.2 Take-off and climb
 - 4.5.3 Flight (including inflight engine stop/start procedures)
 - 4.5.4 Approach
 - 4.5.5 Landing
 - 4.5.6 Flight with water ballast
 - 4.5.7 High altitude flight
 - 4.5.8 Flight in rain
 - 4.5.9 Aerobatics

(Model Designation or Document No.)**4.1 Introduction**

Section 4 provides checklists and amplified procedures for the conduct of normal operation. Normal procedures associated with optional systems can be found in Section 9.

4.2 Rigging and de-rigging.

(The procedure for rigging and de-rigging must be explained. Special attention must be drawn to connections to be made in the control systems and the attachment points of wings and empennage).

4.3 Daily inspection

(The recommended daily inspection must be explained)

(Note: The daily inspection could be continued in the Maintenance Manual but should primarily be in the Flight Manual, as it is related to pilot activity).

4.4 Pre-flight inspection

(The recommended pre-flight inspection must be explained. Special attention must be drawn to connections in the control systems and the attachment points of wing and empennage).

4.5 Normal procedures and recommended speeds

(This chapter must contain the recommended normal procedures for the phases listed under 4.5.1 through 4.5.9 and the recommended air speeds, if applicable.

If take-off, flight and landing characteristics are different in rain this should be specially stated herein.

Under 4.5.3 must be noted that flights in conditions conducive to lightning strikes must be avoided, unless the sailplane is approved for lightning strike conditions.

Water ballast tank filling, draining and jettisoning procedure(s) must be described.

Description of continued safe take-off, flight and landing procedures with partial or full water ballast).

Appr 4.2

(Model Designation or Document No.)

Section 5

- 5. Performance
- 5.1 Introduction
- 5.2 Approved data
 - 5.2.1 Airspeed indicator system calibration
 - 5.2.2 Stall speeds
 - 5.2.3 Take-off performance
 - 5.2.4 Additional information
- 5.3 Non-approved further information
 - 5.3.1 Demonstrated crosswind performance
 - 5.3.2 Flight polar
 - 5.3.3 Noise data (for powered sailplanes only)

(Model Designation or Document No.)**5.1** *Introduction*

Section 5 provides approved data for airspeed calibration, stall speeds and take-off performance and non-approved further information.

The data in the charts has been computed from actual flight tests with the sailplane and engine in good condition and using average piloting techniques.

5.2 *Approved data***5.2.1** *Airspeed indicator system calibration*

(The data must be presented as Calibrated Airspeed (CAS) versus Indicated Airspeed (IAS) assuming zero instrument error. The presentation should include all flap setting configurations and should cover the appropriate speed operating range).

5.2.2 *Stall speeds*

(The data must be presented as indicated airspeed versus flap setting configurations and angle of bank at maximum weight with and without water-ballast; in case of a powered sailplane, with throttle closed.

Altitude loss of more than 30m and pitch below the horizon of more than 30 degrees during recovery from stalls should be added, if applicable).

5.2.3 *Take-off performance*

(For powered sailplanes take-off distances).

5.2.4 *Additional Information* (Information must be provided according to CS 22.1581 (c))**5.3** *Non-approved further information (In this section further information should be presented as follows:)***5.3.1** *Demonstrated crosswind performance*

(The maximum crosswind velocity at which take-offs and landings have been demonstrated should be presented together with the launching methods used).

5.3.2 *Flight polar*

(For sailplanes the rate-of-descent versus flight speed should be presented, including minimum descent speed and best angle of glide speed.

For powered sailplanes additional data should be presented as endurance time versus altitude for various power settings and at least a full fuel loading with the engine running all the time).

5.3.3 *Noise data (for powered sailplanes only)*

(The certificated noise data must be presented).

Appr. 5.2

(Model Designation or Document No.)

Section 6

- 6. Weight and balance
- 6.1 Introduction
- 6.2 Weight and Balance Record and permitted payload-range

6.1

(Model Designation or Document No.)**6.1 *Introduction***

This Section contains the payload range within which the sailplane may be safely operated.

Procedures for weighing the sailplane and the calculation method for establishing the permitted payload range and a comprehensive list of all equipment available for this sailplane and the installed equipment during the weighing of the sailplane are contained in the applicable Maintenance Manual Doc. No.

6.2

(Model Designation or Document No.)

6.2 *Weight and Balance Record/permitted payload range*

valid for Serial No

Date	Empty weight	c/g Pos.	Permitted pilot weight				Approved	
			with water-ballast		without water-ballast		Date	Signed
			Max.	Min.	Max.	Min.		
Example for a single seater								

For calculation of the permitted max. and min. pilot weight refer to Maintenance Manual Doc. No.

(The influence of fuel and water-ballast must be furnished)

valid for Serial No

Date	Empty Weight	c/g. pos.	Permitted crew + passenger weight with:												Approved	
			Max. baggage ... kg				Half baggage ... kg				No baggage				Date	Signed
			Front seat		Rear seat		Front seat		Rear seat		Front seat		Rear seat			
			Max.	Min.	Max.	Min.	Max.	Min.	Max.	Min.	Max.	Min.	Max.	Min.		
EXAMPLE FOR A TANDEM SEATER																

For calculation of the max. and min. crew + passenger weight refer to Maintenance Manual Doc. No.....

6.3

(Model Designation or Document No.)**Section 7**

Note: The following is an example of items which may be included in this Section.
Duplication of information is not necessary and should be avoided.

- 7. General sailplane and systems description
 - 7.1 Introduction
 - 7.2 Cockpit controls
 - 7.3 Instrument panel
 - 7.4 Landing gear system
 - 7.5 Seats and safety harness
 - 7.6 Pitot and static system
 - 7.7 Air brake system
 - 7.8 Baggage Compartment
 - 7.9 Water ballast system
 - 7.10 Powerplant
 - 7.11 Fuel system
 - 7.12 Electrical system
 - 7.13 Miscellaneous equipment

7.1

(Model Designation or Document No.)**7.1 *Introduction***

This Section provides description and operation of the sailplane and its systems. Refer to Section 9, Supplements, for details of optional systems and equipment.

7.2 *Cockpit controls*

(Describe the arrangement of the cockpit controls and their operating functions).

7.3 *Instrument panel*

(Provide a drawing or picture of the instrument panel. Identify the instruments, lights switches, circuit breakers and warning lights installed on the panel or in the cockpit).

7.4 *Landing gear system*

(Describe the system and explain the use of it).

7.5 *Seats and safety harness*

(Describe the adjustment of the seats, if applicable, and the safety harness installed).

7.6 *Pitot and static system*

(Describe the system with a good schematic).

7.7 *Airbrake System*

(Describe the kind of the system; airbrakes, flaps or brake-chutes and explain the use of it, if necessary).

7.8 *Baggage compartment*

(Describe location and tie-down provisions. Explain restrictions regarding weight and kind of baggage).

7.9 *Water-ballast system*

(Describe the system with a good schematic and explain the operation and anti-freeze recommendation).

7.10 *Powerplant*

(Describe the engine, the engine controls and instrumentation. Describe the propeller and explain how the propeller should operate).

7.11 *Fuel System*

(Describe the system with a good schematic and explain the operation.
Explain unusable fuel.
Explain the fuel measuring system and the fuel venting system.
Explain the fuel/oil mixing method).

7.12 *Electrical system*

(Describe the system by use of simplified schematics.
Explain how this system operates including warning and control devices.
Explain circuit protections. Discuss battery capacity and load shedding).

7.13 *Miscellaneous equipment*

(Describe important equipment not already covered).

(Model Designation or Document No.)

Section 8

- 8. Sailplane handling, care and maintenance
 - 8.1 Introduction
 - 8.2 Sailplane inspection periods
 - 8.3 Sailplane alterations or repairs
 - 8.4 Ground handling/road transport
 - 8.5 Cleaning and care

8.1

(Model Designation or Document No.)**8.1 *Introduction***

This Section contains manufacturer's recommended procedures for proper ground handling and servicing of the sailplane. It also identifies certain inspection and maintenance requirements which must be followed if the sailplane is to retain that new-plane performance and dependability. It is wise to follow a planned schedule of lubrication and preventive maintenance based on climatic and flying conditions encountered.

8.2 *Sailplane inspection period*

(Reference to Maintenance Manual of the (powered) sailplane)

8.3 *Sailplane alterations or repairs*

It is essential that the Agency be contacted prior to any alterations on the sailplane to ensure that the airworthiness of the sailplane is not compromised.

For repairs refer to the applicable Maintenance Manual Doc. No.....

8.4 *Ground handling / road transport*

(Describe the carrying and lifting provisions for the sailplane.

Explain the following procedures, if applicable:

- (a) Towing
- (b) Parking
- (c) Tie-down
- (d) Preparing for road transport with special instructions for attaching the wings, fuselage and empennage in the transport vehicle, if appropriate).

8.5 *Cleaning and care*

(Describe cleaning procedures for at least the following aircraft items:

canopy

painted exterior surfaces (especially the leading edge of the wing)

and explain the recommended cleaning agents and give caution notes, if necessary).

(Model Designation or Document No.)

Section 9

- 9. Supplements
- 9.1 Introduction
- 9.2 List of inserted supplements
- 9.3 Supplements inserted

9.1

(Model Designation or Document No.)

9.1 *Introduction*

This Section contains the appropriate supplements necessary to safely and efficiently operate the sailplane when equipped with various optional systems and equipment not provided with the standard sailplane.

9.2 *List of inserted supplements*

Date of Insertion	Doc. No.	Title of inserted supplement

9.3 *Supplements inserted*

(Each supplement must normally cover only a single system, device or piece of equipment such as a removable powerplant or an autopilot system. The supplement may be issued by the sailplane manufacturer or by any other manufacturer of the applicable item.

The supplement must be approved by the Agency and must contain all deviations and changes relative to the basic Flight Manual.

Each supplement must be a self-contained, miniature Flight Manual with at least the following:

Section 1, General

The purpose of the Supplement and the system or equipment to which it specifically applies must be stated.

Section 2, Limitations

Any change to the Limitations, markings or placards of the basic Flight Manual must be stated. If there is no change, a statement to that effect must be made.

Section 3, Emergency Procedures

Any addition or change to the basic emergency procedures of the Flight Manual must be stated. If there is no change, a statement to that effect must be made.

Section 4, Normal Procedures

Any addition or change to the basic normal procedures of the Flight Manual must be stated. If there is no change, a statement to that effect must be made.

Section 5, Performance

Any effect of the subject installation upon sailplane performance as shown in the basic Flight Manual must be indicated. If there is no change, a statement to that effect must be made.

Section 6, Weight and balance

Any effect of the subject installation upon weight and balance of the sailplane must be indicated. If there is no change, a statement to that effect must be made)

AMC 22.1583(a)
Operating limitations

For the purpose of explaining the significance of V_{RA} , all air movements in lee-wave rotors, thunder- clouds, visible whirlwinds, or over mountain crests, are to be understood as rough air.

AMC 22.1585(f)
Operating data and procedures

Slip characteristic description should include:

- (1) qualitative effectiveness of the manoeuvre;
- (2) speed range above the recommended approach speed (see CS 22.1545(e)) within which the manoeuvre can be safely performed;
- (3) the appropriate pilot action in response to a control force decrease or reversal;
- (4) degradation, if any, in the airspeed system accuracy during the slip; and
- (5) the effect of a partial water-ballast.

SUBPART H - ENGINES**AMC 22.1801****Applicability**

- (a) When spark ignition is provided a single ignition system is acceptable.
- (b) Engines certificated under CS-E are accepted as complying with this Subpart H.

AMC 22.1823 (a)**Engine mounting attachments and structure**

The maximum allowable loads should take account of the flight and ground loads and the emergency alighting loads specified in CS-22 for the sailplane as a whole.

AMC 22.1843**Vibration test**

The propeller should be so chosen that the prescribed maximum rotational speed is obtained at full throttle or at the desired maximum permissible manifold pressure, whichever is appropriate.

SUBPART J - PROPELLERS

AMC 22.1901
Applicability

Propellers certificated under CS-P are accepted as complying with Subpart J.

APPENDIX K - AEROTOWING OF SAILPLANES WITH POWERED SAILPLANES**AMC 22-Appendix K paragraph 1.1**

AMC 22.21 applies to the aerotow and is amended by introducing a new paragraph (4):

- (4) For the proof of compliance with the requirements of CS-22, Book 1, Subpart B during the aero-towing of sailplanes by powered sailplanes, tests with at least three different representative sailplane types covering the whole permissible range of aerotowed sailplanes should be conducted. During these tests, the weights of the aerotowing powered sailplane and of the sailplane, the aerodynamic characteristics, speed range and ground handling characteristics should be combined appropriately so as to obtain conservative results.